

Pop Up Displays

SYNC

SYNC 22c.....	PS-1
SYNC 33c.....	PS-2
SYNC 43c.....	PS-3
SYNC 83 Serpentine.....	PS-4
SYNC 83 Gullwing.....	PS-5
SYNC Accessories.....	PS-6

Vburst

vBurst 8' Select Kits.....	PF-1
vBurst 10' Kits.....	PF-2
vBurst 20' Kits.....	PF-3
vBurst Specifications & Accessories.....	PF-4
vBurst A-La Carte Pricing.....	PF-5
vBurst Curved Backlit 3x3.....	PF-6
vBurst Curved Backlit 4x3.....	PF-7
vBurst Curved Backlit 2x2.....	PF-8
vBurst Flat Backlit 3x3.....	PF-10
vBurst Flat Backlit 4x3.....	PF-11

Xpressions

Xpressions SNAP! Select.....	PK-1
Xpressions SNAP! 1x3.....	PK-2
Xpressions SNAP! 1x3 continued.....	PK-3
Xpressions SNAP! 2x2.....	PK-4
Xpressions SNAP! 2x3.....	PK-5
Xpressions SNAP! 3 Quad Pyramid.....	PK-6
Xpressions SNAP! 3x3.....	PK-7
Xpressions SNAP! 4x3 Metric.....	PK-8
Xpressions SNAP! 4x3 US.....	PK-9
Xpressions SNAP! 4x3 US continued.....	PK-10
Xpressions SNAP! 5 Quad X.....	PK-11
Xpressions SNAP! 6 Quad Pyramid.....	PK-12
Xpressions SNAP! 10 Quad Pyramid.....	PK-13
Xpressions SNAP! 4x4.....	PK-14
Xpressions SNAP! Argyle.....	PK-15
Xpressions SNAP! Projector.....	PF-16
Xpressions SNAP! Accessories.....	PK-17
Xpressions Frame Dimensions Chart.....	PK-18
Xpressions SNAP! A La Cart Pricing.....	PK-19
Xpressions LED LightBox 1x3 & 2x3.....	PK-20
Xpressions LED LightBox 3x3.....	PK-21
Xpressions express.....	PK-22
Xpressions express continued.....	PK-23
Xpressions CONNEX Octagon A & 10'A.....	PK-24
Xpressions CONNEX 10'B & C.....	PK-25
Xpressions CONNEX 10'D & E.....	PK-26
Xpressions CONNEX 20'A & B.....	PK-27
Xpressions CONNEX 20'C & D.....	PK-28
Xpressions CONNEX 20'(E).....	PK-29
Xpressions CONNEX 20' Islaland A & B.....	PK-30
Xpressions SHEER 1x3 kits.....	PK-31
Xpressions SHEER 3x3 kits.....	PK-32
Xpressions SHEER 4x3US kits.....	PK-33
Salesmate 2x2.....	PK-34
Salesmate 3 Quad pyramid.....	PK-35
Salesmate 2x2 Exhibitor Series.....	PK-36
Salesmate 3 Quad Exhibitor Series.....	PK-37
Salesmate 4x3 Exhibitor Series.....	PK-38
Salesmate A La Cart Pricing.....	PK-39

Xpressions PUSHTHRU.....	PK-40
Little Giant case-to-counter/XSNAP!.....	PK-41
Xpressions CONNEX LED Lightboxes.....	PK-42
Xpressions QTR/20.....	PK-43
Xpressions QTR/20 <i>continued</i>	PK-44
Xpressions QTR/20 Accessories.....	PK-45

Twist

Twist.....	PT-1
Twist <i>continued</i>	PT-2

Expand Linkwall

Linkwall.....	PL-1
---------------	------

Banner Stands

Retractable

Eco-1st Bamboo.....	BR-1
Grand Stand.....	BR-2
M2.....	BR-3
MediaScreen 1.....	BR-4
MediaScreen 2 <i>indoor</i>	BR-5
MediaScreen 4.....	BR-6
MediaScreen 2 AWD <i>outdoor</i>	BR-7
MediaScreen XL.....	BR-8
Pronto.....	BR-9
Pronto <i>continued</i>	BR-10
Pronto 2.....	BR-11
Pronto 2 <i>continued</i>	BR-12
QuickScreen 1.....	BR-13
QuickScreen 1 <i>continued</i>	BR-14
QuickScreen 3.....	BR-15
QuickScreen 3 <i>continued</i>	BR-16
Sidewinder.....	BR-17
Expolinc Roll Up Classic.....	BR-18
the Set.....	BR-19
Media Screen 3.....	BR-20
Spennare Roll Up S10 Wide.....	BR-21

Stand Alone

Alfresco.....	BS-1
Compass.....	BS-2
Concierge.....	BS-3
Courier.....	BS-4
Eco-1st Bamboo L-Stand.....	BS-5
Multiplier.....	BS-6
Expolinc 4 Screen Classic.....	BS-7

Telescoping

Sprint.....	BT-1
Sprint <i>continued</i>	BT-2
Summit.....	BT-3
Summit <i>continued</i>	BT-4
Summit Style.....	BT-5
Summit Style <i>continued</i>	BT-6

Backwalls

Range.....	BB-1
Relay.....	BB-2
The Wall.....	BB-3
Twist.....	BB-4
Twist <i>continued</i>	BB-5
Maxibit Scene Ultralight.....	BB-6

Graphics - Graphic Processes

Dye Sublimation

Big Banner Finishing	GD-1
Colossus.....	GD-2
Kaleidoscope Select	GD-3
Fabric Applications Chart	GD-4
Fabric Applications Chart <i>continued</i>	GD-5
Silicone Edge Graphics (SEG).....	GD-6
Silicone Edge Graphics (SEG) <i>continued</i>	GD-7
In Step carpet graphics.....	GD-8

Lambda

Mural Pricing by Manufacturer.....	GL-1
Lambda Bright & Duratrans.....	GL-2
Lambda Floor Graphics.....	GL-2
Lambda Duraflex & Metallic.....	GL-3
Lambda specifications.....	GL-4
Dry Erase Laminate	GL-5

Solvent Printing

Solv-it!.....	GS-1
Solv-it! <i>cont.</i>	GS-2
Window Perf	GS-3

UV Direct Printing

Mesa	GU-1
UV direct print.....	GU-2
UV direct print <i>continued</i>	GU-3
Reposition-it.....	GU-4
Streetag.....	GU-5
uVision-it.....	GU-6

Vinyl Cut Graphics

Individual Lettering & Logos	GV-1
Vinyl Graphics on Substrates	GV-2

Graphics

QuickDrop.....	GG-1
----------------	------

Floor Graphics

Streetag	GF-1
InStep Carpet Graphics	GF-2
InStep Vinyl Flooring	GF-3
Lambda Floor Graphics	GF-4

Table Throws & Chairs

Director Chairs.....	T-1
Director Chairs <i>continued</i>	T-2
TableThrows <i>Runners, Unprinted & Perma Logo</i>	T-3
TableThrows <i>Perma Logo vinyl & Fabric colors</i>	T-4
TableThrows <i>Flocking, Applique & Perma Logo</i>	T-5
TableThrows <i>Dye Sub Logo Applique,</i> <i>Dye Sub front transfer & over entire throw</i>	T-6
TableThrows <i>continued</i>	T-7
V-Throw	T-8

Table Tops

Wind Table Top	TT-1
Wave Table Top	TT-2
Surf Table Top	TT-3
Gust Table Top	TT-4
Splash Table Top	TT-5
Salesmate 2x2 Exhibitor Series.....	TT-6
Salesmate 3 Quad Exhibitor Series	TT-7
Salesmate 4x3 Exhibitor Series.....	TT-8
Salesmate A La Cart Pricing	TT-9
UltraLight X Series	TT-10
UltraLight X Series <i>cont</i>	TT-11

iPad Kiosks & Holders

iPad Kiosk	iP-1
iPad Kiosk <i>continued</i>	iP-2
iPad Clamshell	iP-3
iPad Clamshell Swivel	iP-4
iPad Custom Kiosk	iP-5

Counters & Monitor Stands

2N1	CM-1
Little Giant	CM-2
Xpressions 223 Counter	CM-3
Expolinc Soft image Counter	CM-4
Clear Top Counter: Modesto	CM-5
Xpressions 223 Workstation	CM-6
Xpressions Monster Monitor Tower	CM-7
Spennare Monitor Mount	CM-8
Xpressions Monster Monitor 8ft Display	CM-9
Expand Podium	CM-10
Duo Hello	CM-11

Tension Fabric/Tube Structures

Aviator Hanging Signs

Circle Hanging	HA-1
Pinwheel Hanging	HA-2
Four-Sided Rectangle Hanging	HA-3
Square Hanging	HA-4
Tapered Circle Hanging	HA-5
Tapered Square Hanging	HA-6
Triangle Hanging	HA-7

Aviator Table Tops

Wind Table Top	HT-1
Wave Table Top	HT-2
Surf Table Top	HT-3
Gust Table Top	HT-4
Splash Table Top	HT-5

Navigator

10ft Backwall	HP-1
10ft Concave	HP-2
10ft Wave	HP-3
10ft Serpentine	HP-4
20ft Serpentine	HP-5
Single Radial Top	HP-6

Double Radial Top	HP-7
Ribbon	HP-8
Double Radial Top w/ iPad station	HP-9
Ellipse Backlit	HP-10
20ft with Endcaps & Backlit Counter	HP-11

SEG/Extrusion Systems

AURA Lightboxes	HS-1
Infinity	HS-2
Nouveau	HS-3
Nouveau <i>continued</i>	HS-4
Nouveau Trade Show Kits	HS-5
Panoramic Intro	HS-6
Panoramic (Tower A)	HS-7
Panoramic (Tower B)	HS-8
Panoramic (Tower C)	HS-9
Panoramic (Tower D)	HS-10
Panoramic (Wall 10A)	HS-11
Panoramic (Wall 10B)	HS-12
Panoramic (Wall 10C)	HS-13
Panoramic (Wall 10D)	HS-14
Panoramic (Wall 20A)	HS-15
Panoramic (Wall 20B)	HS-16
Panoramic (Wall 20C)	HS-17
Panoramic (Wall 20D)	HS-18
Panoramic (Room A)	HS-19
Panoramic (Room B)	HS-20
Panoramic (Counter A)	HS-21
Panoramic (Counter B)	HS-22
Panoramic (Counter C)	HS-23
Panoramic Frame Hardware	HS-24
Panoramic Frame Hardware <i>cont.</i>	HS-25
Panoramic Accessories	HS-26
Panoramic Accessories <i>cont.</i>	HS-27
Panoramic Accessories <i>cont.</i>	HS-28
Silicone Edge Graphics (SEG)	HS-29
Panoramic Kits 10'x10'	HS-30 & 31
Panoramic Kits 10' x 20'	HS-32 ,33,34 & 35
Panoramic Kits 20' x 20	HS-36 & HS-37
Pliko	HS-38
Panoramic iPad Kiosk	HS-39
Panoramic Lightboxes 8ft & 10ft Wide	HS-40

Outdoor / Event Products

Alfresco	O-1
Banshee	O-2
Banshee <i>continued</i>	O-3
BaseLine	O-4
Event Tent 10' x 10'	O-5
Event Tent 10' x 20'	O-6
Event Tent Accessories	O-7
MediaScreen 2 AWD	O-8
Outpost	O-9
Rally Banner	O-10

Ridgeline	O-11
Skyblade	O-12
Skyblade <i>continued</i>	O-13
Valet	O-14
Kapow	O-15
Boulevard Polls for Banners	O-16
Barricade Covers	O-17

Backlits

2N1	X-1
AURA	X-2
LED Light Frame	X-3
Power Panel	X-4
Ultimate Backlit Header System	X-5
AURA Lambda Duratrans option	X-6
vBurst Curved Backlit 3x3	X-7
vBurst Curved Backlit 4x3	X-8
vBurst Curved Backlit 2x2	X-9
vBurst Flat Backlit 3x3	X-10
vBurst Flat Backlit 4x3	X-11
Xpressions LED LightBox 1x3 & 2x3	X-12
Xpressions LED LightBox 3x3	X-13
Xpressions CONNEX LED Lightboxes	X-14
Pliko	X-15
Panoramic Lightboxes 8ft & 10ft Wide	X-16

Display Cases

Display Cases	C-1
Display Cases <i>continued</i>	C-2

Lights and Accessories

Hanging Hardware for Large Banners	L-1
Lights	L-2
Banner Rail, Boulevard Polls, Steamer, Spline Roller, Stakes, Magnets, Sand Bag ...	L-3
Velcro, Easels, Fixture Adapters	L-4

Additional Information

Accounting & Turnaround	J-1
Art Files	J-2
Proofs, Quality Discount & Misc.	J-3
Ordering, Contact info	J-4
Graphic Design	J-5
Graphic Design	J-6
Warranty & Guarantee	J-7
Index	I-1



Self locking pop-up system

Pricing as shown:

2x2 Sync Frame	\$275
Lambda Bright Mural w/Fabric endcaps	\$428
200w Halogen light	\$ 68
Sync-EZ™ Roller case	\$175

Total \$946
Table Throw not included



Add a case-to-counter cover graphic for \$250



2x2 Sync Frame
 w/Fabric Endcaps, Fabric Front Panels, Light & Case
Throw not included
\$830
 Without light subtract \$68



2x2 Sync Frame
 w/Fabric Endcaps, Light & Case
Throw not included
\$654
 Without light subtract \$68



2x2 Sync Frame only
 (includes channel bars), Light & Case
Throw not included
\$518
 Without light subtract \$68

Specifications

- Size: 5'3"h x 5'5"w
- Weight: 60lbs. (Frame, Graphics, Channel Bars and Shipping Case)
- System: 2 quad x 2 quad curved self locking, light weight, fully cross braced pop-up system
- Fabric Panel & Endcap Options: Silver/Grey Fronrunner (PMS 423c)
 Blue Imperial Fronrunner (PMS 2757c)
 Black Coal Fronrunner (Pantone Black)

Additional Pricing Options (Includes listed items only)

• 2x2 frame, Lambda Bright Mural & Lambda endcaps	\$ 767
• 2x2 frame, Lambda Bright Mural & Fabric endcaps	\$ 703
• 2x2 frame, Lambda Bright Mural w/out endcaps	\$ 567
• 2x2 frame, Fabric Mural with Fabric endcaps	\$ 587
• 2x2 frame, Flex or Metallic w/Lambda endcaps	\$ 847
• 2x2 frame, Flex or Metallic w/fabric endcaps	\$ 753
• 2x2 frame, Flex or Metallic w/out endcaps	\$ 617

Accessories

See SYNC accessories on Page PS - 6



Self locking pop-up system

Pricing as shown:

3x3 Sync Frame	\$395
Lambda Bright Mural w/Fabric endcaps	\$830
200w Halogen light (x2)	\$136
Sync-EZ™ Roller case	\$175

Total \$1,536



Add a case-to-counter cover graphic for \$250



3x3 Sync Frame w/Fabric Endcaps, Fabric Front Panels, Lights & Case \$1,206
Without lights subtract \$136



3x3 Sync Frame w/Fabric Endcaps, Lights & Case \$876
Without lights subtract \$136



3x3 Sync Frame only (includes channel bars), Lights & Case \$706
Without lights subtract \$136

Specifications

Size: 8'h x 8'w

Weight: 70lbs. (Frame, Graphics, Channel Bars and Shipping Case)

System: 3 quad x 3 quad curved self locking, light weight, fully cross braced pop-up system

Fabric Panel & Endcap Options: Silver/Grey Frontrunner (PMS 423c)
Blue Imperial Frontrunner (PMS 2757c)
Black Coal Frontrunner (Pantone Black)

Additional Pricing Options (Includes listed items only)

• 3x3 frame, Lambda Bright Mural & Lambda endcaps	\$1,355
• 3x3 frame, Lambda Bright Mural & Fabric endcaps	\$1,225
• 3x3 frame, Lambda Bright Mural w/out endcaps	\$1,055
• 3x3 frame, Fabric Mural with Fabric endcaps	\$ 895
• 3x3 frame, Flex or Metallic w/Lambda endcaps	\$1,460
• 3x3 frame, Flex or Metallic w/fabric endcaps	\$1,300
• 3x3 frame, Flex or Metallic w/out endcaps	\$1,130

Accessories

See SYNC accessories on Page PS - 6

SYNC™ 43c

Self locking pop-up system

Pricing as shown:

4x3 Sync Frame	\$ 505
Lambda Bright Mural w/Fabric endcaps	\$1,050
200w Halogen light (x3)	\$ 204
Sync-EZ™ Roller cass	\$ 175

Total \$1,934



Add a case-to-counter cover graphic for \$250



4x3 Sync Frame
w/Fabric Endcaps,
Fabric Front Panels,
Lights & Case
\$1,494
Without lights subtract \$204



4x3 Sync Frame
w/Fabric Endcaps,
Lights & Case
\$1,054
Without lights subtract \$204



4x3 Sync Frame only
(includes channel bars),
Lights & Case
\$884
Without lights subtract \$204

Specifications

Size: 8'h x 10'w

Weight: 80lbs. (Frame, Graphics, Channel Bars and Shipping Case)

System: 4 quad x 3 quad curved self locking, light weight,
fully cross braced pop-up system

Fabric Panel & Endcap Options: Silver/Grey Frontrunner (PMS 423c)
Blue Imperial Frontrunner (PMS 2757c)
Black Coal Frontrunner (Pantone Black)

Additional Pricing Options (Includes listed items only)

• 4x3 frame, Lambda Bright Mural & Lambda endcaps	\$1,685
• 4x3 frame, Lambda Bright Mural & Fabric endcaps	\$1,555
• 4x3 frame, Lambda Bright Mural w/out endcaps	\$1,385
• 4x3 frame, Fabric Mural with Fabric endcaps	\$1,115
• 4x3 frame, Flex or Metallic w/Lambda endcaps	\$1,815
• 4x3 frame, Flex or Metallic w/fabric endcaps	\$1,655
• 4x3 frame, Flex or Metallic w/out endcaps	\$1,485

Accessories

See SYNC accessories on Page PS - 6



Self locking pop-up system

Pricing as shown:

- 4x3 Sync Frame (x2)\$1,010
- Lambda Bright Mural w/Fabric
endcaps\$1,958
- Sync-EZ™ Roller cass (x2)\$ 350

Total \$3,318

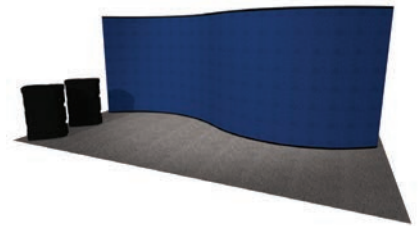

Two 4x3 Sync Frames
w/Fabric Endcaps,
Fabric Front Panels,
& Two Cases
\$2,450



Add a case-to-counter
cover graphic for \$250



Two 4x3 Sync Frames
w/Fabric Endcaps
& Two Cases
\$1,530

Specifications

- Size: 8'h x 19'4"w
- Weight: 160lbs. (Frame,Graphics, Channel Bars and Shipping Case)
- System: 8quad x 3quad curved self locking, light weight,
fully cross braced pop-up system
- Fabric Panel & Endcap Options: Silver/Grey Frontrunner (PMS 423c)
Blue Imperial Frontrunner (PMS 2757c)
Black Coal Frontrunner (Pantone Black)

Additional Pricing Options (Includes listed items only)

- 4x3 (x2) frame, Lambda Bright Mural & Lambda endcaps \$3,100
- 4x3 (x2) frame, Lambda Bright Mural & Fabric endcaps \$2,968
- 4x3 (x2) frame, Lambda Bright Mural w/out endcaps \$2,800

Accessories

See SYNC accessories on Page PS - 6

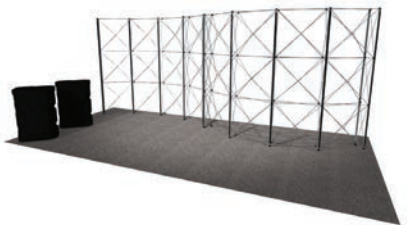

Two 4x3 Sync Frames only
(includes channel bars)
& Two Cases
\$1,360



Self locking pop-up system

Pricing as shown:

- 4x3 Sync Frame (x2)\$1,010
- Lambda Bright Mural w/Lambda endcaps\$2,068
- Sync-EZ™ Roller cass (x2)\$ 350

Total \$3,428



Add a case-to-counter cover graphic for \$250

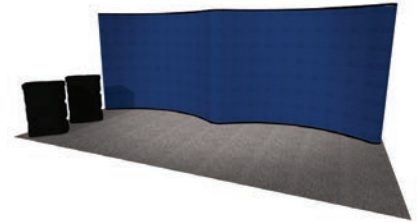

Two 4x3 Sync Frames w/Fabric Endcaps, Fabric Front Panels & Two Cases \$2,535

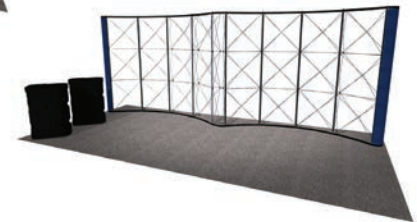

Two 4x3 Sync Frames w/Fabric Endcaps & Two Cases \$1,530

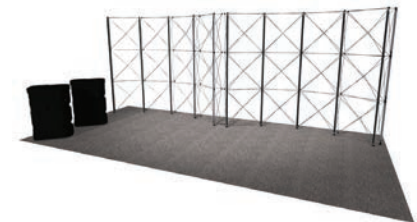

Two 4x3 Sync Frames only (includes channel bars) & Two Cases \$1,360

Specifications

Size: 8'h x 20'w

Weight: 160lbs. (Frame,Graphics, Channel Bars and Shipping Case)

System: 8quad x 3quad curved self locking, light weight, fully cross braced pop-up system

Fabric Panel & Endcap Options: Silver/Grey Frontrunner (PMS 423c)
 Blue Imperial Frontrunner (PMS 2757c)
 Black Coal Frontrunner (Pantone Black)

Additional Pricing Options (Includes listed items only)

- 4x3 (x2) frame, Lambda Bright Mural & Lambda endcaps \$3,210
- 4x3 (x2) frame, Lambda Bright Mural & Fabric endcaps \$3,078
- 4x3 (x2) frame, Lambda Bright Mural w/out endcaps \$2,910

Accessories

See SYNC accessories on Page PS - 6



Lights

150w Halogen ...\$42

200w Halogen ...\$68



LED Pop-up Light;
available in black\$88 ea.



SYNC™ Light Case ...\$30

Shipping Cases



SYNC™ case ...\$225



SYNC-EZ™ Roller case
w/foam inserts & graphic
dividers\$175



SYNC Monitor Mount:
Max sized monitor recommended is 22"
Dim: 29"x7"h Weight: 3.75lbs
Price \$146
*Graphic will need a 6" x 6" cutout for the
monitor bracket. Recommended 24"
down from top for placement of cutout.*



SYNC™ case-to-counter
cover
• \$260 Lambda (shown)
• \$250 Dyesub (available)

Case-to-Counter Draped Covers

- With dyesub applique
- With 1 color perma logo
- With full dyesub Kaleidoscope Select
- Plain solid color cover
- Blotter for Case
- Lambda Bright HDL counter graphic for SYNC™ case

	SYNC-EZ™ Roller (draped or fitted)	SYNC™ (draped only)
	\$175	\$175
	\$145	\$145
	\$250	\$250
	\$ 70	\$ 70
	\$ 10	\$ 25
	N/A	\$260



Two Case Option / x2 "O" cases,
14" x 39.5" (\$100 each)\$200

Replacement Items

- Replacement Fabric End Caps /Silver/Grey Frontrunner (PMS 423c), Blue Imperial Frontrunner (PMS 2757c) or Black-ecofi Lava (Pantone Black)
- Replacement Fabric Front Panels /Silver/Grey Frontrunner (PMS 423c), Blue Imperial Frontrunner (PMS 2757c) or Black Coal Frontrunner (Pantone Black)
- Replacement Lambda Bright mural panel
- Replacement Lambda Bright end caps
- Replacement Lambda flex or metallic mural panel
- Replacement Lambda flex or metallic end caps
- Replacement Channel Bar

	Standard	Table Top
	\$ 90 each	\$ 75 each
	\$115 each	\$ 95 each
	\$245 each	\$160 each
	\$150 each	\$100 each
	\$270 each	\$185 each
	\$165 each	\$115 each
	\$ 25 each	\$ 20 each



All steel
connection hubs

Back Panels

- 22c, 33c and 43c
- 83serpentine & 83gullwing

	Standard	Table Top
	\$270 each	\$197 each
	\$540 each	N/A



Slide-on channel
bar mounted lights

Power Panel Kits (Includes Power Panel, reflector panel and light kit)

Power Panel Kit Total:

- Lambda Duratrans Power Panel with HDL

	Standard	6' Table Top
	\$702	\$459

Power Panel Component List:

- Lambda Duratrans Power Panel with HDL Laminate
- Reflector Panel
- Light Kit

	\$427	\$299
	\$105	\$ 70
	\$170	\$ 90

Replacement Items:

- Light Fixture with Wingnut
- Bulb

	\$ 50	\$ 50
	\$ 18	\$ 18



New generation of light
weight bungee connected
channel bars featuring
recessed magnets



The VBurst is a fabric pop-up system with a fabric graphic already attached to the frame, using Velcro. It is available as either a flat wall or curved display.

The VBurst graphic is a Kaleidoscope Select or Colossus dye sublimation fabric graphic. When the unit is set up, the graphic unfolds with the frame and stretches to form a completely smooth image across the entire display. The VBurst can be purchased with or without end panels. End panels are simply a wider graphic wrapped around the ends of the pop-up frame.

The VBurst system comes with a nylon-carrying bag. Adjustable feet are included on each unit. The VBurst frame can be purchased without a graphic.



3x3 HD Dye Sub Flat VBurst w/ Endcaps \$1,008

Pricing (includes graphics, unit and carry bag)



Wholesale Package Price: \$1,552 (HD Dye Sub Process)

- 8' Kit Flat Select 10'x10' space:**
- HD Dye Sub Process.
 - One 3x3 flat frame with graphic.
 - End caps.
 - One case.
 - One case to counter conversion kit.
 - Counter fabric graphic.
 - Counter blotter (writing surface)
 - Two lights with packing foam.



Wholesale Package Price: \$1,529 (HD Dye Sub Process)

- 8' Kit Curved Select 10'x10' space:**
- HD Dye Sub Process.
 - One 3x3 curved frame with graphic.
 - End caps.
 - One case.
 - One case to counter conversion kit.
 - Counter fabric graphic.
 - Counter blotter (writing surface)
 - Two lights with packing foam.



10' X 10' Fabric Display Kits Wholesale Pricing

Combine multiple VBurst displays to create complete table top, 10' and 10' exhibits. Kits include accessories like table throws, lights and case-to-counter conversions. Everything you need at one great wholesale price.



Wholesale Package Price:
\$1,799 (Colossus 8 Process)

10' Flat Kit A 10'x10' space:

- One 4x3 flat fabric graphic display w/ends caps
- One case
- One case-to-counter conversion kit includes fabric graphic and blotter (hard writing surface)
- Four lights (includes packing foam)



Wholesale Package Price:
\$1,484 (Kaleidoscope Process)

Table Top Kit D 10'x10' space:

- One 3x2 flat fabric graphic display with end caps
- One 8ft table throw w/Dye Sub Applique
- One case
- One case-to-counter conversion kit includes fabric graphic and blotter (hard writing surface)
- Three lights (includes packing foam)



Wholesale Package Price:
\$1,783 (Colossus 8 Process)

10' Curved Kit B 10'x10' space:

- One 4x3 curved fabric graphic display w/ends caps
- One case
- One case-to-counter conversion kit includes fabric graphic and blotter (hard writing surface)
- Four lights (includes packing foam)



Wholesale Package Price:
\$2,685 (Kaleidoscope Process)

10'x10' Kit E space:

- Two 1x3 flat fabric graphic displays w/end caps
- One 2x3 flat fabric graphic display with end caps
- Two cases
- Two case-to-counter conversion kits includes fabric graphic and blotter (hard writing surface)
- Four lights (includes packing foam)



Wholesale Package Price:
\$1,322 (Kaleidoscope Process)

Table Top Kit C 10'x10' space:

- One 2x2 flat fabric graphic display w/ends caps
- One 8ft full front dye sublimation table throw
- One case
- One case-to-counter conversion kit includes fabric graphic and blotter (hard writing surface)
- Two lights (includes packing foam)



Wholesale Package Price:
\$1,944 (Kaleidoscope Process)

10'x10' Kit F space:

- Three 1x3 flat fabric graphic displays w/end caps
- One case
- One case-to-counter conversion kit includes fabric graphic and blotter (hard writing surface)
- Three lights (includes packing foam)



10' X 20' Fabric Display Kits Wholesale Pricing

Combine multiple VBurst displays to create complete table top, 10' and 20' exhibits. Kits include accessories like table throws, lights and case-to-counter conversions. Everything you need at one great wholesale price.



Wholesale Package Price:
\$4,183 (Colossus 8 Process)

10'x20' Kit A space:

- One 4x3 curved fabric graphic display w/end caps
- Two 2x3 flat fabric graphic displays w/end caps
- Three cases
- Three case-to-counter conversion kits includes fabric graphics and blotter (hard writing surface)
- Six lights (includes packing foam)



Wholesale Package Price:
\$3,932 (Colossus 8 Process)

10'x20' Kit D space:

- One 3x3 curved fabric graphic display w/end caps
- Two 2x3 flat fabric graphic displays w/end caps
- Three case
- Three case-to-counter conversion kits includes fabric graphic and blotter (hard writing surface)
- Seven lights (includes packing foam)



Wholesale Package Price:
\$4,145 (Colossus 8 Process)

10'x20' Kit B space:

- One 2x3 flat fabric graphic displays w/end caps
- Two 3x3 curved fabric graphic displays w/end caps
- Three cases
- Three case-to-counter conversion kits includes fabric graphic and blotter (hard writing surface)
- Six lights (includes packing foam)



Wholesale Package Price:
\$4,364 (Kaleidoscope Process)

10'x20' Kit E space:

- Two 2x3 flat fabric graphic displays w/end caps
- Three 1x3 flat fabric graphic displays w/end caps
- Three case
- Three case-to-counter conversion kits includes fabric graphic and blotter (hard writing surface)
- Four lights (includes packing foam)



Wholesale Package Price:
\$4,198 (Colossus 8 Process)

10'x20' Kit C space:

- One 4x3 flat fabric graphic display w/end caps
- Two 2x3 flat fabric graphic displays w/end caps
- Three cases
- Three case-to-counter conversion kits includes fabric graphics and blotter (hard writing surface)
- Six lights (includes packing foam)



Wholesale Package Price:
\$5,068 (Colossus 8 Process)

10'x20' Kit F space:

- One 3x3 curved fabric graphic display w/end caps
- Two 2x3 flat fabric graphic displays w/end caps
- Two 1x3 flat fabric graphic displays w/end caps
- Three case
- Three case-to-counter conversion kits includes fabric graphic and blotter (hard writing surface)
- Nine lights (includes packing foam)



Specifications

- Weight: (includes graphic, stand & bag)

Flat

1x3	13 lbs.	4x3	29 lbs.
2x2	17 lbs.	4x4	31 lbs.
2x3/3x2	19 lbs.	5x3	34 lbs.
3x3	23lbs.		

Curved

2x2	17 lbs.
3x3	23 lbs.
4x3	29 lbs.

- The Burst is available in three fabric options:
 - 1) Gaming Suede – lightly napped material similar to felt, with fantastic wrinkle-resistance and opacity.
 - 2) Poly Knit – smooth surface with excellent wrinkle resistance and opacity.
 - 3) Brilliance - Heavy knit material with deep color saturation, wrinkle resist and great opacity.

- If you are purchasing a frame only and require endcap brackets add \$6.00 per bracket:

Ex: If you purchase a 2X2 burst frame only with brackets;

Frame price	\$170
Bracket price	+ \$36 (6 x \$6.00 - 3 per side)
Total	\$206

Accessories

Lights

150 watt halogen; available in black\$42 ea.



LED Pop-up light; available in black\$88 ea.



Universal BCL light; 35 watt halogen available in silver ...\$55 ea.



Monitor Mount

Spennare monitor mount Price \$495 ea.

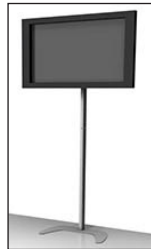

Spennare monitor mount works with Flat and Curved displays.

Shipping Case

Burst Case 38.5”h (including space in the top) x 27”w x 15.5”d cost \$160

Foam Pack for light storage (optional) \$20

ABS Counter top

Blotter (optional) \$10

Total Case-to-Counter

Conversion kit cost\$190



Number of required end cap brackets:

$\frac{1 \times 3}{8}$	$\frac{2 \times 2}{6}$	$\frac{2 \times 3 / 3 \times 2}{8/6}$	$\frac{3 \times 3}{8}$	$\frac{4 \times 3}{8}$	$\frac{4 \times 4}{10}$	$\frac{5 \times 3}{8}$
------------------------	------------------------	---------------------------------------	------------------------	------------------------	-------------------------	------------------------

Cover for case to counter conversion	Draped Cover	Form Fitted Cover
With dyesub applique	\$175	NA
With 1 color Perma Logo	\$145	NA
With full dyesub 4 color	\$250	\$250
With full dyesub 8 color	\$270	\$270
Plain solid color cover	\$70	NA



Draped Cover



Form Fitted Cover

Discounts for Duplicate Images Only The price of the hardware unit is passed on to you at Optima’s cost plus shipping and handling and is not discountable. The graphics are discounted based on duplicate volume. To determine the discount % for the multiple units, multiply the price for a quantity of one by the following factors:

Quantity	Discount Factor
2-5	.97
6-10	.96
11-15	.95
16-25	.94
26-50	.93
Above 50	Call for quote



A - La Carte Pricing

The VBurst is a fabric pop-up system with a fabric graphic already attached to the frame, using Velcro. It is available as either a flat wall or curved display. The VBurst graphic is a Kaleidoscope Select or Colossus dye sublimation fabric graphic. When the unit is set up, the graphic unfolds with the frame and stretches to form a completely smooth image across the entire display. The VBurst can be purchased with or without end panels. End panels are simply a wider graphic wrapped around the ends of the pop-up frame. The VBurst system comes with a nylon-carrying bag. Adjustable feet are included on each unit. The VBurst frame can be purchased without a graphic.

Available Now!



Same Price as 8 Color Colossus!

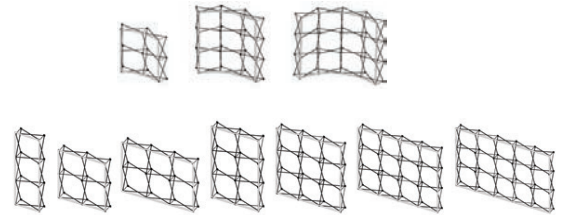

Flat VBurst

Unit Size	Graphic Size WxH		VBurst w/Kaleidoscope Select		VBurst w/4 Color Colossus		VBurst w/8 Color Colossus	
	(w/o endcaps)	(w/endcaps)	(w/o endcaps)	(w/endcaps)	(w/o endcaps)	(w/endcaps)	(w/o endcaps)	(w/endcaps)
1x3	31" x 87.75"	55" x 87.75"	\$339	\$511	\$331	\$501	\$349	\$535
2x2	59.5" x 59.5"	83.5" x 59.5"	\$420	\$550	\$408	\$504	\$433	\$539
2x3	59.5" x 87.75"	83.5" x 87.75"	\$589	\$756	\$568	\$709	\$604	\$761
3x2	87.75" x 59.5"	111.75" x 59.5"	\$589	\$699	\$568	\$663	\$604	\$710
3x3	87.75" x 87.75"	111.75" x 87.75"	\$902	\$1064	\$798	\$939	\$852	\$1008
4x3	116.625" x 87.75"	140.625" x 87.75"	\$1174	\$1330	\$1037	\$1178	\$1108	\$1265
4x4	116.625" x 116.75"	140.625" x 116.625"	\$1481	\$1678	\$1357	\$1504	\$1453	\$1656
5x3	145.5" x 87.75"	169.5" x 87.75"	\$1401	\$1556	\$1277	\$1418	\$1366	\$1522

Flat Wall VBurst replacement graphic, deduct the following from the Flat Wall price above. This is also the price of the unit only.

1 x 3	2 x 2	2 x 3/ 3 x 2	3 x 3	4 x 3	4 x 4	5 x 3
\$151	\$170	\$216	\$285	\$353	\$448	\$422

Monitor Mount

Spennare monitor mount Price \$495 ea.

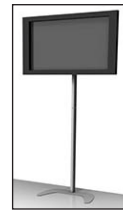

Monitor mount works with Flat and Curved displays.

Curved VBurst (Seamless)

Unit Size	Graphic Size WxH		VBurst w/Kaleidoscope Select		VBurst w/4 Color Colossus		VBurst w/8 Color Colossus	
	(w/o endcaps)	(w/endcaps)	(w/o endcaps)	(w/endcaps)	(w/o endcaps)	(w/endcaps)	(w/o endcaps)	(w/endcaps)
2x2	53.5" x 59.5"	77.5" x 59.5"	\$509	\$615	\$495	\$598	\$518	\$631
3x3	78.75" x 87.75"	102.75" x 87.75"	\$854	\$1009	\$784	\$921	\$833	\$985
4x3	105.75" x 87.75"	129.75" x 87.75"	\$1110	\$1278	\$1017	\$1169	\$1082	\$1249

Curved VBurst replacement graphic, deduct the following from the Curved VBurst price above. This is also the price of the unit only.

2 x 2	3 x 3	4 x 3
\$270	\$302	\$370

VBURST BACKLIT LIGHT KIT - Kit includes lights, power cords, backside fabric cover. Recommended for use with Optima Backlit VBurst Fabric Graphic.

• 8' = \$493 fits 3x3 VBurst Frame • 10' = \$635 fits 4x3 VBurst Frame

NOTE:

For Kaleidoscope Select graphics 2x3 or larger a seam will be required.



VBurst Fabric Curved Pop-ups are now available with a backlighting kit! Convenience, functionality and good looks make VBurst the smart choice for event media backdrops and trade shows. Nothing highlights a message like the power of back-

lighting. Unlike competitive backlit fabric backwalls, the VBurst light kit is a simple, easy-to-use solution...no fussing with unruly or broken fabric light walls. Other systems are clunky and complicated, VBurst keeps it simple.

With the VBurst Backlit kit, simply hang the three or four light bars, apply a separate fabric backwall cover and plug it in. The backwall velcro attaches to the side of the frame and the front fabric graphic endcaps attach to the backwall at the back hub. The result is a clean and professional looking system that is easy to set-up and easy to pack. The front fabric graphic with endcaps is printed with HD Dye Sublimation on backlit material.

When you need a backlit media wall, want to highlight your marketing message or just want to bring your image to life through the power of light, look no further - order a VBurst Backlit Fabric Pop-up!



Price As Shown* \$1,918

Kit Itemization



Backlighting brings your Image to Life!

*As Shown Details:

- * HD Dye Sub Fabric Graphic with Endcaps
- * One 3x3 curved frame
- * One case
- * One case-to-counter conversion kit
- * Counter fabric graphic
- * Counter blotter (writing surface)
- * Backlit light kit and fabric backcover
- * Fits 10'x10' Space

Shipping Weight: 60 lbs. (Includes Steamer)



Add a Portable Steamer for \$58



Light kit on 3x3 8ft. frame.



Light kit hanging on frame.



Fabric backcover and front graphic installation.



VBurst Fabric Curved Pop-ups are now available with a backlighting kit! Convenience, functionality and good looks make VBurst the smart choice for event media backdrops and trade shows. Nothing highlights a message like the power of backlighting. Unlike competitive backlit fabric backwalls, the VBurst light kit is a simple, easy-to-use solution...no fussing with unruly or broken fabric light walls. Other systems are clunky and complicated, VBurst keeps it simple.

With the VBurst Backlit kit, simply hang the three or four light bars, apply a separate fabric backwall cover and plug it in. The backwall velcro attaches to the side of the frame and the front fabric graphic endcaps attach to the backwall at the back hub. The result is a clean and professional looking system that is easy to set-up and easy to pack. The front fabric graphic with endcaps is printed with HD Dye Sublimation on backlit material.

When you need a backlit media wall, want to highlight your marketing message or just want to bring your image to life through the power of light, look no further - order a VBurst Backlit Fabric Pop-up!



Price As Shown* \$2,230

Kit Itemization

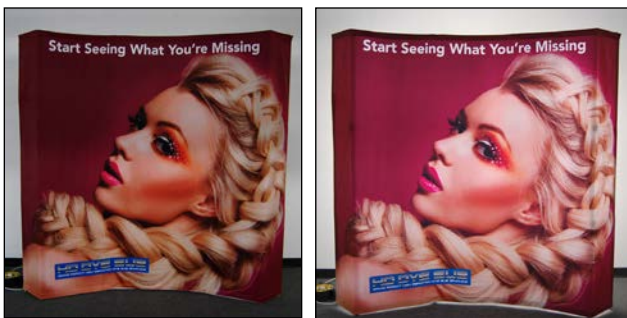

Backlighting brings your Image to Life!

*As Shown Details:

- * HD Dye Sub Process Fabric Graphic with Endcaps
- * One 4x3 curved frame
- * One case
- * One case-to-counter conversion kit
- * Counter fabric graphic
- * Counter blotter (writing surface)
- * Backlit light kit and fabric backcover
- * Fits 10'x10' Space

Shipping Weight: 60 lbs. (Includes Steamer)



Add a Portable Steamer for \$58



Light kit on 3x3 8ft. frame.



Light kit hanging on frame.



Fabric backcover and front graphic installation.



VBurst Fabric Curved Pop-ups are now available with a backlighting kit! Convenience, functionality and good looks make VBurst the smart choice for events and trade shows. Nothing highlights a message like the power of backlighting. Unlike the competition, the VBurst light kit is a simple, easy-to-use solution... no fussing with unruly or broken fabric light walls. Other systems are clunky and complicated, VBurst keeps it simple.

With the VBurst Backlit kit, simply hang the light bars, apply a separate fabric backwall cover and plug it in. The backwall velcro attaches to the side of the frame and the front fabric graphic endcaps attach to the backwall at the back hub. The result is a clean and professional looking system that is easy to set-up and easy to pack. The front fabric graphic with endcaps is printed with HD Dye Sublimation on backlit material.

When you need a backlit table top, want to highlight your marketing message or just want to bring your image to life through the power of light, look no further - Get a 2x2 Curved VBurst Backlit Fabric Pop-up!



2x2 Curved VBurst Backlit

Price As Shown* \$931
Table throw not included.

Kit Itemization

- *As Shown Details: (Fits 10'x10' Space)**
- 2x2 curved VBurst frame with HD Dye Sub Fabric Graphic w/ Endcaps \$631
- Backlit light kit \$170
- Unprinted fabric backcover (102" w x 87.75" h) \$130
- Total Cost \$931**



Backlighting brings your Image to Life!

Shipping Weight: 35 lbs. (Includes Steamer) Table throw not included.

Add a Portable Steamer for \$58



Light kit hanging on frame.

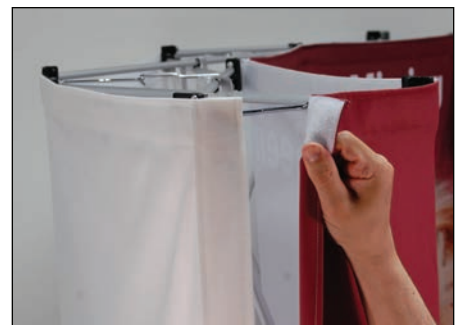

Inatallation of fabric backcover and front graphic at end cap.

BURST!SL

The Burst!SL is a self-locking, fabric back wall system. No hooks to latch! Simply open the frame and your display is complete. The graphic unfolds with the frame and stretches to produce a smooth, continuous image. Manual lock(s) are included within the framework if additional graphic tension is desired. The durable, lightweight frame allows for easy set-up in less than a minute – no tools required. End caps are available for all three frame sizes. The Burst!SL can be enhanced with additional accessories listed on the next page.

NOTE:

For Kaleidoscope Select graphics 2x3 or larger a seam will be required.



3x3 8 color Colossus Flat Burst!SL w/Endcaps \$1,348

Pricing (includes graphics and unit)

Flat Burst SL

Unit Size	Graphic Size WxH		Burst!SL w/Kaleidoscope Select		Burst!SL w/4 Color Colossus		Burst!SL w/8 Color Colossus	
	(w/o endcaps)	(w/endcaps)	(w/o endcaps)	(w/endcaps)	(w/o endcaps)	(w/endcaps)	(w/o endcaps)	(w/endcaps)
2x2	62.5" x 62.5"	88.5" x 62.5"	\$571	\$704	\$558	\$687	\$585	\$725
2x3	62.5" x 93"	88.5" x 93"	\$886	\$1080	\$864	\$1054	\$904	\$1111
3x3	93" x 93"	119" x 93"	\$1168	\$1379	\$1081	\$1271	\$1141	\$1348

Lights

200 watt halogen; available in black \$68 ea.



Bag

Black canvas carrying bag \$40

Frame Color

2x2 & 2x3 Silver
3x3 Black

Shipping Case

Burst Case 38.5"h (including space in the top) x 27"w x 15.5"d cost \$160

Foam Pack for light storage (optional) \$20
ABS Counter top
Blotter (optional) \$10

Total Case to Counter
Conversion kit cost \$190



Burst!SL replacement graphic, deduct the following from the pricing above. (This is also the price of the unit only.)

<u>Without Endcaps:</u>		
<u>2 x 2</u>	<u>2 x 3</u>	<u>3 x 3</u>
\$300	\$480	\$510
<u>With Endcaps:</u>		
<u>2 x 2</u>	<u>2 x 3</u>	<u>3 x 3</u>
\$320	\$510	\$540

Number of required end cap brackets:

<u>2 x 2</u>	<u>2 x 3</u>	<u>3 x 3</u>
6	8/6	8

Cover for case to counter conversion	Draped Cover	Form Fitted Cover
With dyesub applique	\$175	NA
With 1 color Perma Logo	\$145	NA
With full dyesub 4 color	\$250	\$250
With full dyesub 8 color	\$270	\$270
Plain solid color cover	\$70	NA



Draped Cover



Form Fitted Cover

Discounts for Duplicate Images Only The price of the hardware unit is passed on to you at Optima's cost plus shipping and handling and is not discountable. The graphics are discounted based on duplicate volume. To determine the discount % for the multiple units, multiply the price for a quantity of one by the following factors:

Quantity	Discount Factor
2-5	.97
6-10	.96
11-15	.95
16-25	.94
26-50	.93
Above 50	Call for quote



The VBurst 3x3 Flat BACKLIT is the only pop up backlit on the market that does not show hub shadows on the center of the graphic face. This process is so revolutionary that the product is patent pending.

Convenience, functionality and good looks make VBurst backlits the smart choice for events and trade shows. Unlike the competition, the VBurst light kit is a simple, easy-to-use solution... no fussing with unruly or broken fabric light walls. Other systems are clunky and complicated, VBurst keeps it simple.

When you need a backlit for your 10' x 10' space, want to highlight your marketing message or just want to bring your image to life through the power of light, look no further - Get a 3x3 Flat VBurst Backlit Fabric Pop-up!



3x3 Flat Backlit w/front dyesub & back unprinted graphics and light kit \$1,516

Pricing

- VBurst 3x3 backlit frame \$300
- Light Kit & Unprinted back graphic..... \$493
- Dye sub front Graphic w/endcaps \$723

Total \$1,516



Light kit hanging on frame.



Fabric backcover and front graphic installation.

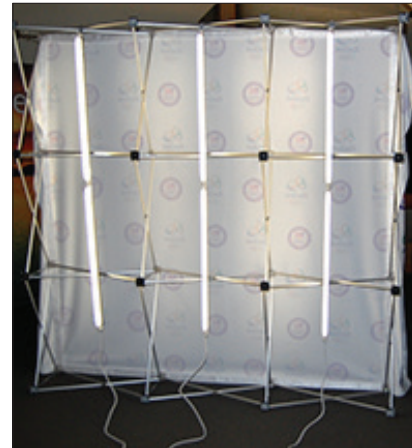

Back view of light kit

Specifications

Graphic Specifications:

- Dye sub Front ... 114.5" x 88"
- Unprinted Back ... 93" x 88"

Lights:

- Aluminum light hooks (3 per light kit)
- 34" T5 flourescent lights (6 lights per light kit)

3x3 Backlit Frame:

- Open ... 88 x 88 x 12.5
- Collaped ... 12 x 12 x 32

Shipping Weight:

- 3x3 frame only 20 lbs.
- 3x3 frame,graphics and light kit 35 lbs.

Accessoriess

Cover for case to counter conversion	Draped Cover	Form Fitted Cover
With dyesub applique	\$175	NA
With 1 color Perma Logo	\$145	NA
With full dyesub 4 color	\$250	\$250
With full dyesub 8 color	\$270	\$270
Plain solid color cover	\$70	NA

Shipping Case

VBurst Case 38.5"h x 27"w x 15.5"d (including space in the top) \$160

ABS Counter top Blotter (optional) \$10

Total Case to Counter Conversion kit cost \$170



Form Fitted Cover



Draped Cover



The VBurst 4x3 Flat BACKLIT is the only pop up backlit on the market that does not show hub shadows on the center of the graphic face. This process is so revolutionary that the product is patent pending.

Convenience, functionality and good looks make VBurst backlits the smart choice for events and trade shows. Unlike the competition, the VBurst light kit is a simple, easy-to-use solution... no fussing with unruly or broken fabric light walls. Other systems are clunky and complicated, VBurst keeps it simple.

When you need a backlit for your 10' x 10' space, want to highlight your marketing message or just want to bring your image to life through the power of light, look no further - Get a 4x3 Flat VBurst Backlit Fabric Pop-up!



4x3 Flat Backlit w/front dyesub & back unprinted graphics and light kit \$1,919

Pricing

- VBurst 4x3 backlit frame \$372
- Light Kit & Unprinted back graphic..... \$635
- Dye sub front Graphic w/endcaps \$912
- Total \$1,919**



Light kit hanging on frame.



Fabric backcover and front graphic installation.



Back view of light kit

Specifications

Graphic Specifications:

Dye sub Front ... 143.375" x 88"
 Unprinted Back ... 121.5" x 88"

Lights:

Aluminum light hooks
 (4 per light kit)

34" T5 flourescent lights
 (8 lights per light kit)

4x3 Backlit Frame:

Open ... 117 x 88 x 12.5
 Collaped ... 15 x 12 x 32

Shipping Weight:

4x3 frame only 23 lbs.
 4x3 frame,graphics and light kit 45 lbs.

Accessoriess

Cover for case to counter conversion	Draped Cover	Form Fitted Cover
With dyesub applique	\$175	NA
With 1 color Perma Logo	\$145	NA
With full dyesub 4 color	\$250	\$250
With full dyesub 8 color	\$270	\$270
Plain solid color cover	\$70	NA

Shipping Case

VBurst Case 38.5"h x 27"w x 15.5"d
 (including space in the top) \$160

ABS Counter top
 Blotter (optional) \$10

Total Case to Counter
 Conversion kit cost \$170



Form Fitted Cover



Draped Cover



The Xpressions® display is wildly popular with trade show and special event industry designers. Custom frame and graphic combinations are too numerous to catalog, so we've made it simple! The creators of the original Xpressions® have packaged, in complete kit form, our most popular Xpressions®SNAP!™ displays. We call this collection Xpressions®SNAP!™ SELECT™.

Easy to set-up and easy to use, Xpressions® is the ultimate in-frame graphic technology! The display is shipped with the fabric skins fully attached to the frame. The versatility of the Xpressions® display allows you to change graphics easily in the field. These designs are proven winners right out of the box!



Dimensions
Open: 32.25"W x 94"H x 12.75"D
Closed: 3.5"W x 7"L x 33.75"H

Kit Weight
21 lbs.

XSNAP™ 1x3 A
frame & graphics \$501
- 50 watt halogen light \$59
- Hard shipping case \$144
Total Price \$704
recycled graphic option add \$27



Dimensions
Open: 93.5"W x 94"H x 12.75"D
Closed: 7"W x 7"L x 33.75"H

Kit Weight
32 lbs.

XSNAP™ 3x3 Q
frame & graphics \$1470
- 50 watt halogen lights (3) \$177
- Hard shipping case \$144
Total Price \$1791
recycled graphic option add \$79



Dimensions
Open: 63"W x 63.25"H x 12.75"D
Closed: 6"W x 6"L x 33.75"H

Kit Weight
30 lbs.

XSNAP™ 2x2 A
frame & graphics \$845
- 6'-8' Converta table throw
with 1 color perma logo \$135
- 50 watt halogen lights (2) \$118
- Hard shipping case \$144
Total price \$1242
recycled graphic option add \$52



Dimensions
Open: 117.5"W x 89.5"H x 13"D
Closed: 10"W x 9"L x 32.5"H

Kit Weight
42 lbs.

XSNAP™ 4x3US B
frame & graphics \$2090
- 50 watt halogen lights (4) \$236
- Hard shipping case \$144
- Shelving (2) \$84
Total Price \$2554
recycled graphic option add \$124



Dimensions
Open: 63"W x 94"H x 12.75"D
Closed: 6"W x 7"L x 33.75"H

Kit Weight
29 lbs.

XSNAP™ 2x3 A
frame & graphics \$1076
- 50 watt halogen lights (2) \$118
- Hard shipping case \$144
Total Price \$1338
recycled graphic option add \$61

Don't need a hard shipping case?
Optional Canvas Bag Black canvas w/ handles;



Weight: 3.2 lbs. (w/o graphic)
Dim: 35"w x 10"d x 9"h
Price \$48 ea.

xpressions[®]SNAP![™] 1 x 3 Kits

Xpressions[®] SNAP![™] ... the ultimate in frame-graphic technology! Create a stunning 3-dimensional display to increase your sales ... in a SNAP![™] Twelve standard frames, two planes for integrated graphics, and infinite configurations, offer you a visual playground to create dramatic effects. Xpressions[®] offers endless design possibilities! The Xpressions[®] frame is shipped with the fabric skins fully attached. The portable, lightweight frame makes your display set-up a SNAP![™] No tools or event labor required. Simply grasp with both hands evenly the right and left side of the center quad within the frame, then gently lift upward. Strong magnetic connectors "SNAP" lock the frame automatically within seconds! The versatility of this frame allows you to change graphics in the field easily creating a totally fresh display. The Xpressions[®] SNAP![™] is truly unlike any display! Let your imagination flow and watch your sales soar! Your message deserves the best ... Beware of the imitators, provide your customers with the authentic original Xpressions[®] SNAP![™] and benefit from it's no questions asked lifetime frame warranty!



1x3 XSnap[™] (E) Regular
Fabric w/shelf \$528
Open Dim. 32.25"w x 94"h

1 x 3 Kits



Configuration A
Regular Fabric \$501
Recycled Fabric \$528



Configuration B
Regular Fabric \$638
Recycled Fabric \$678



Configuration C
Regular Fabric \$501
Recycled Fabric \$528



Configuration D
Regular Fabric \$486
Recycled Fabric \$511



Configuration E
Regular Fabric \$486
Recycled Fabric \$511



Configuration F
Regular Fabric \$589
Recycled Fabric \$624



Configuration G
Regular Fabric \$574
Recycled Fabric \$608



Configuration H
Regular Fabric \$486
Recycled Fabric \$511



Configuration I
Regular Fabric \$501
Recycled Fabric \$528



Configuration J
Regular Fabric \$589
Recycled Fabric \$624



Configuration K
Regular Fabric \$486
Recycled Fabric \$511



Configuration L
Regular Fabric \$462
Recycled Fabric \$485



Configuration M
Regular Fabric \$765
Recycled Fabric \$818



Configuration N
Regular Fabric \$682
Recycled Fabric \$726



Configuration O
Regular Fabric \$709
Recycled Fabric \$757

- See Xpressions[®] SNAP![™] Accessories Pricing on Page PF - 20
- See Xpressions[®] SNAP![™] A La Carte Graphic Wholesale Pricing on Page PF - 22

xpressions[®]SNAP![™] 1 x 3 Kits *Continued*

Xpressions[®] SNAP![™] ... the ultimate in frame-graphic technology! Create a stunning 3-dimensional display to increase your sales ... in a SNAP![™] Twelve standard frames, two planes for integrated graphics, and infinite configurations, offer you a visual playground to create dramatic effects. Xpressions[®] offers endless design possibilities! The Xpressions[®] frame is shipped with the fabric skins fully attached. The portable, lightweight frame makes your display set-up a SNAP![™] No tools or event labor required. Simply grasp with both hands evenly the right and left side of the center quad within the frame, then gently lift upward. Strong magnetic connectors "SNAP" lock the frame automatically within seconds! The versatility of this frame allows you to change graphics in the field easily creating a totally fresh display. The Xpressions[®] SNAP![™] is truly unlike any display! Let your imagination flow and watch your sales soar! Your message deserves the best ... Beware of the imitators, provide your customers with the authentic original Xpressions[®] SNAP![™] and benefit from it's no questions asked lifetime frame warranty!



1x3 XSnap[™] (P)
Regular Fabric \$550
Open Dim. 32.25"w x 94"h

1 x 3 Kits



Configuration P
Regular Fabric \$550
Recycled Fabric \$582



Configuration Q
Regular Fabric \$583
Recycled Fabric \$617



Configuration R
Regular Fabric \$550
Recycled Fabric \$582

- See Xpressions[®] SNAP![™] Accessories Pricing on Page PF - 20
- See Xpressions[®] SNAP![™] A La Carte Graphic Wholesale Pricing on Page PF - 22

xpressions[®] SNAP![™] 2 x 2 Kits

Xpressions[®] SNAP![™] ... the ultimate in frame-graphic technology! Create a stunning 3-dimensional display to increase your sales ... in a SNAP![™] Twelve standard frames, two planes for integrated graphics, and infinite configurations, offer you a visual playground to create dramatic effects. Xpressions[®] offers endless design possibilities! The Xpressions[®] frame is shipped with the fabric skins fully attached. The portable, lightweight frame makes your display set-up a SNAP![™] No tools or event labor required. Simply grasp with both hands evenly the right and left side of the center quad within the frame, then gently lift upward. Strong magnetic connectors "SNAP" lock the frame automatically within seconds! The versatility of this frame allows you to change graphics in the field easily creating a totally fresh display. The Xpressions[®] SNAP![™] is truly unlike any display! Let your imagination flow and watch your sales soar! Your message deserves the best ... Beware of the imitators, provide your customers with the authentic original Xpressions[®] SNAP![™] and benefit from it's no questions asked lifetime frame warranty!



2x2 XSnap[™] (A)
Regular Fabric \$845
Open Dim. 63"w x 63.25"h

● 2 x 2 Kits

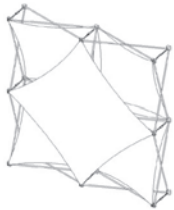

Configuration A
Regular Fabric \$845
Recycled Fabric \$897



Configuration B
Regular Fabric \$830
Recycled Fabric \$880

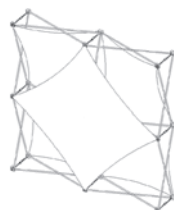

Configuration C
Regular Fabric \$816
Recycled Fabric \$865



Configuration D
Regular Fabric \$654
Recycled Fabric \$686

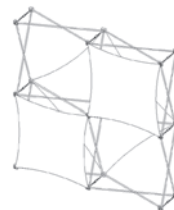

Configuration E
Regular Fabric \$668
Recycled Fabric \$702

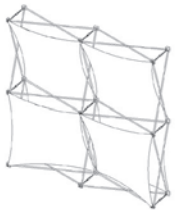

Configuration F
Regular Fabric \$830
Recycled Fabric \$880

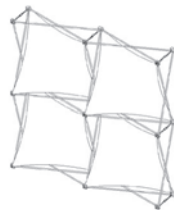

Configuration G
Regular Fabric \$683
Recycled Fabric \$718

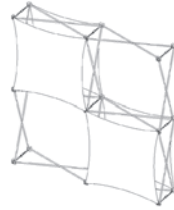

Configuration H
Regular Fabric \$683
Recycled Fabric \$718

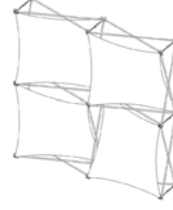

Configuration I
Regular Fabric \$683
Recycled Fabric \$718

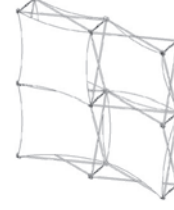

Configuration J
Regular Fabric \$757
Recycled Fabric \$800

- See Xpressions[®] SNAP![™] Accessories Pricing on Page PF - 20
- See Xpressions[®] SNAP![™] A La Carte Graphic Wholesale Pricing on Page PF - 22

xpressions[®]SNAP![™] 2 x 3 Kits

Xpressions[®] SNAP![™] ... the ultimate in frame-graphic technology! Create a stunning 3-dimensional display to increase your sales ... in a SNAP![™] Twelve standard frames, two planes for integrated graphics, and infinite configurations, offer you a visual playground to create dramatic effects. Xpressions[®] offers endless design possibilities! The Xpressions[®] frame is shipped with the fabric skins fully attached. The portable, lightweight frame makes your display set-up a SNAP![™] No tools or event labor required. Simply grasp with both hands evenly the right and left side of the center quad within the frame, then gently lift upward. Strong magnetic connectors "SNAP" lock the frame automatically within seconds! The versatility of this frame allows you to change graphics in the field easily creating a totally fresh display. The Xpressions[®] SNAP![™] is truly unlike any display! Let your imagination flow and watch your sales soar! Your message deserves the best ... Beware of the imitators, provide your customers with the authentic original Xpressions[®] SNAP![™] and benefit from it's no questions asked lifetime frame warranty!



2x3 XSnap[™] (H) Regular
Fabric w/ 3 shelves \$1,103
Open Dim. 63"w x 94"h

2 x 3 Kits



Configuration A
Regular Fabric \$1,076
Recycled Fabric \$1,137



Configuration B
Regular Fabric \$1,115
Recycled Fabric \$1,180



Configuration C
Regular Fabric \$962
Recycled Fabric \$1,012



Configuration D
Regular Fabric \$1,110
Recycled Fabric \$1,175



Configuration E
Regular Fabric \$1,090
Recycled Fabric \$1,153



Configuration F
Regular Fabric \$1,168
Recycled Fabric \$1,239



Configuration G
Regular Fabric \$1,213
Recycled Fabric \$1,288

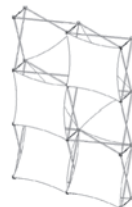

Configuration H
Regular Fabric \$977
Recycled Fabric \$1,029



Configuration I
Regular Fabric \$939
Recycled Fabric \$987

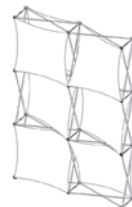

Configuration J
Regular Fabric \$1,079
Recycled Fabric \$1,141

- See Xpressions[®] SNAP![™] Accessories Pricing on Page PF - 20
- See Xpressions[®] SNAP![™] A La Carte Graphic Wholesale Pricing on Page PF - 22

xpressions® SNAP!™

3 Quad Pyramid

Xpressions® SNAP!™ ... the ultimate in frame-graphic technology! Create a stunning 3-dimensional display to increase your sales ... in a SNAP!™ Twelve standard frames, two planes for integrated graphics, and infinite configurations, offer you a visual playground to create dramatic effects. Xpressions® offers endless design possibilities! The Xpressions® frame is shipped with the fabric skins fully attached. The portable, lightweight frame makes your display set-up a SNAP!™ No tools or event labor required. Simply grasp with both hands evenly the right and left side of the center quad within the frame, then gently lift upward. Strong magnetic connectors “SNAP” lock the frame automatically within seconds! The versatility of this frame allows you to change graphics in the field easily creating a totally fresh display. The Xpressions® SNAP!™ is truly unlike any display! Let your imagination flow and watch your sales soar! Your message deserves the best ... Beware of the imitators, provide your customers with the authentic original Xpressions® SNAP!™ and benefit from it's no questions asked lifetime frame warranty!



3Quad Pyramid XSnap™ (A)
Regular Fabric \$505
Open Dim. 90”w x 66”h

3 Quad Pyramid Kits

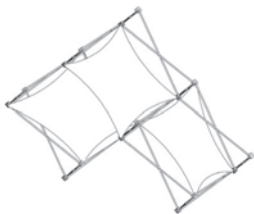

Configuration A
Regular Fabric \$505
Recycled Fabric \$532



Configuration B
Regular Fabric \$667
Recycled Fabric \$710

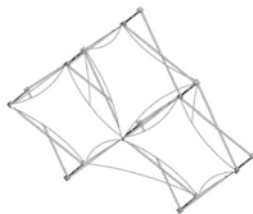

Configuration C
Regular Fabric \$667
Recycled Fabric \$710

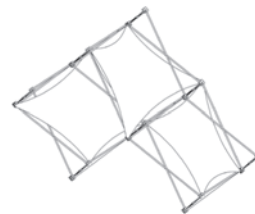

Configuration D
Regular Fabric \$505
Recycled Fabric \$532

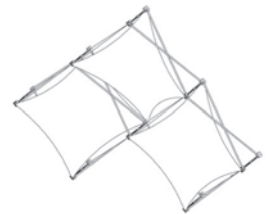

Configuration E
Regular Fabric \$505
Recycled Fabric \$532

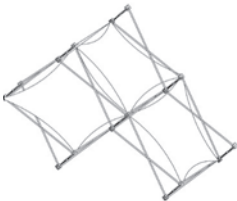

Configuration F
Regular Fabric \$505
Recycled Fabric \$532

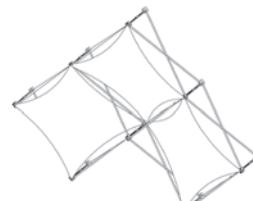

Configuration G
Regular Fabric \$505
Recycled Fabric \$532



Configuration H
Regular Fabric \$505
Recycled Fabric \$532

- See Xpressions® SNAP!™ Accessories Pricing on Page PF - 20
- See Xpressions® SNAP!™ A La Carte Graphic Wholesale Pricing on Page PF - 22

xpressions[®]SNAP![™] 3 x 3

Xpressions[®] SNAP![™] ... the ultimate in frame-graphic technology! Create a stunning 3-dimensional display to increase your sales ... in a SNAP![™] Twelve standard frames, two planes for integrated graphics, and infinite configurations, offer you a visual playground to create dramatic effects. Xpressions[®] offers endless design possibilities! The Xpressions[®] frame is shipped with the fabric skins fully attached. The portable, lightweight frame makes your display set-up a SNAP![™] No tools or event labor required. Simply grasp with both hands evenly the right and left side of the center quad within the frame, then gently lift upward. Strong magnetic connectors "SNAP" lock the frame automatically within seconds! The versatility of this frame allows you to change graphics in the field easily creating a totally fresh display. The Xpressions[®] SNAP![™] is truly unlike any display! Let your imagination flow and watch your sales soar! Your message deserves the best ... Beware of the imitators, provide your customers with the authentic original Xpressions[®] SNAP![™] and benefit from it's no questions asked lifetime frame warranty!



3x3 XSnap[™] (F)
Regular Fabric \$1,544
Open Dim. 93.5" w x 94" h

3 x 3 Kits

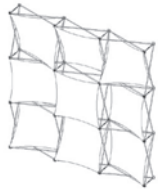

Configuration A
Regular Fabric \$1,470
Recycled Fabric \$1,549



Configuration B
Regular Fabric \$1,481
Recycled Fabric \$1,562



Configuration C
Regular Fabric \$1,338
Recycled Fabric \$1,404

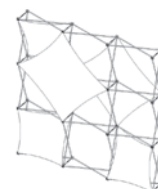

Configuration D
Regular Fabric \$1,265
Recycled Fabric \$1,324

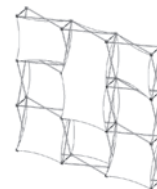

Configuration E
Regular Fabric \$1,500
Recycled Fabric \$1,582

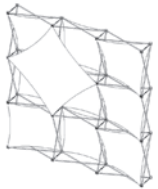

Configuration F
Regular Fabric \$1,544
Recycled Fabric \$1,631



Configuration G
Regular Fabric \$2,001
Recycled Fabric \$2,134

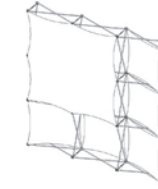

Configuration H
Regular Fabric \$1,418
Recycled Fabric \$1,492

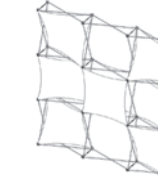

Configuration I
Regular Fabric \$1,343
Recycled Fabric \$1,491

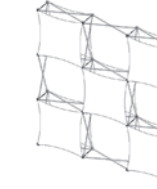

Configuration J
Regular Fabric \$1,558
Recycled Fabric \$1,645

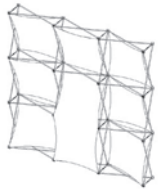

Configuration K
Regular Fabric \$1,431
Recycled Fabric \$1,507

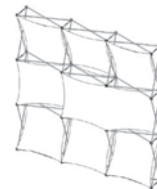

Configuration L
Regular Fabric \$1,628
Recycled Fabric \$1,723



Configuration M
Regular Fabric \$1,418
Recycled Fabric \$1,562



Configuration N
Regular Fabric \$1,491
Recycled Fabric \$1,573

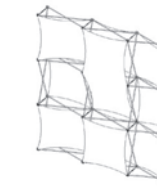

Configuration O
Regular Fabric \$1,554
Recycled Fabric \$1,642



Configuration P
Regular Fabric \$1,566
Recycled Fabric \$1,655

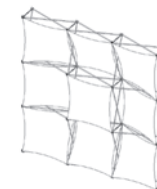

Configuration Q
Regular Fabric \$1,470
Recycled Fabric \$1,549

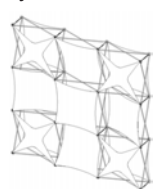

Configuration R
Regular Fabric \$1,872
Recycled Fabric \$1,992

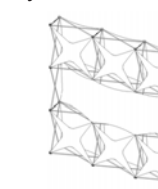

Configuration S
Regular Fabric \$1,960
Recycled Fabric \$2,089



Configuration T
Regular Fabric \$1,618
Recycled Fabric \$1,713

- See Xpressions[®] SNAP![™] Accessories Pricing on Page PF - 20

- See Xpressions[®] SNAP![™] A La Carte Graphic Wholesale Pricing on Page PF - 22

xpressions® SNAP!™ 4 x 3 Metric

Xpressions® SNAP!™ ... the ultimate in frame-graphic technology! Create a stunning 3-dimensional display to increase your sales ... in a SNAP!™ Twelve standard frames, two planes for integrated graphics, and infinite configurations, offer you a visual playground to create dramatic effects. Xpressions® offers endless design possibilities! The Xpressions® frame is shipped with the fabric skins fully attached. The portable, lightweight frame makes your display set-up a SNAP!™ No tools or event labor required. Simply grasp with both hands evenly the right and left side of the center quad within the frame, then gently lift upward. Strong magnetic connectors "SNAP" lock the frame automatically within seconds! The versatility of this frame allows you to change graphics in the field easily creating a totally fresh display. The Xpressions® SNAP!™ is truly unlike any display! Let your imagination flow and watch your sales soar! Your message deserves the best ... Beware of the imitators, provide your customers with the authentic original Xpressions® SNAP!™ and benefit from it's no questions asked lifetime frame warranty!



4x3 Metric XSnap™ (B)
Regular Fabric \$2,090
Open Dim. 124.5"w x 94"h

4 x 3 Metric Kits*

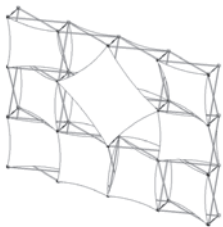

Configuration A
Regular Fabric \$2,040
Recycled Fabric \$2,159

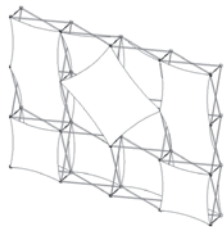

Configuration B
Regular Fabric \$2,090
Recycled Fabric \$2,214

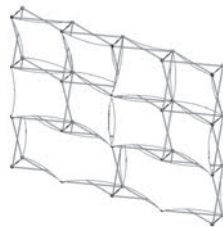

Configuration C
Regular Fabric \$1,849
Recycled Fabric \$1,949

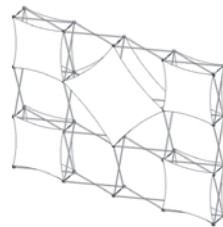

Configuration D
Regular Fabric \$1,878
Recycled Fabric \$1,981

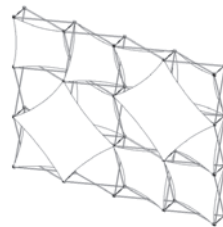

Configuration E
Regular Fabric \$1,966
Recycled Fabric \$2,078

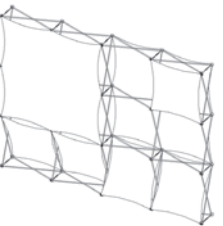

Configuration F
Regular Fabric \$1,890
Recycled Fabric \$1,944

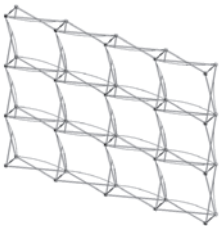

Configuration G
Regular Fabric \$1,906
Recycled Fabric \$2,012

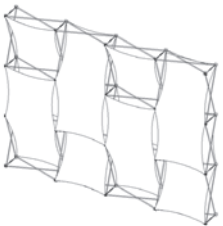

Configuration H
Regular Fabric \$2,144
Recycled Fabric \$2,274

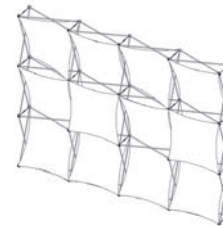

Configuration I
Regular Fabric \$1,977
Recycled Fabric \$2,090

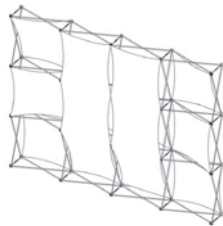

Configuration J
Regular Fabric \$1,967
Recycled Fabric \$2,079

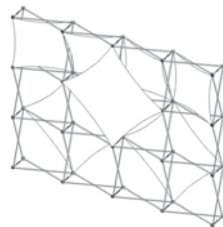

Configuration K
Regular Fabric \$1,687
Recycled Fabric \$1,771

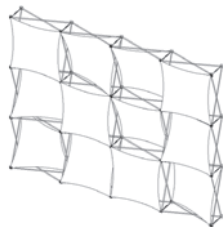

Configuration L
Regular Fabric \$1,906
Recycled Fabric \$2,012

* Special note about SNAP!™ 4x3 metric frames. The 4x3 metric measures 124.5" w extending 4.5" beyond the typical 10' display space. For 10' display space please purchase the Snap!™ 4x3 U.S. measuring 117.5" w.

- See Xpressions® SNAP!™ Accessories Pricing on Page PF - 20
- See Xpressions® SNAP!™ A La Carte Graphic Wholesale Pricing on Page PF - 22

xpressions[®]SNAP![™] 4 x 3 US

Xpressions[®] SNAP![™] ... the ultimate in frame-graphic technology! Create a stunning 3-dimensional display to increase your sales ... in a SNAP![™] Twelve standard frames, two planes for integrated graphics, and infinite configurations, offer you a visual playground to create dramatic effects. Xpressions[®] offers endless design possibilities! The Xpressions[®] frame is shipped with the fabric skins fully attached. The portable, lightweight frame makes your display set-up a SNAP![™] No tools or event labor required. Simply grasp with both hands evenly the right and left side of the center quad within the frame, then gently lift upward. Strong magnetic connectors "SNAP" lock the frame automatically within seconds! The versatility of this frame allows you to change graphics in the field easily creating a totally fresh display. The Xpressions[®] SNAP![™] is truly unlike any display! Let your imagination flow and watch your sales soar! Your message deserves the best ... Beware of the imitators, provide your customers with the authentic original Xpressions[®] SNAP![™] and benefit from it's no questions asked lifetime frame warranty!



4x3 US XSnap[™] (N)
 Recycled Fabric \$2,175
 Open Dim. 117.5"w x 89.5"h

4 x 3 US Kits

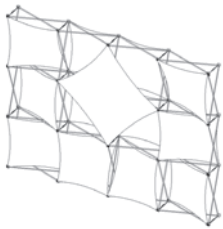

Configuration A
 Regular Fabric \$2,040
 Recycled Fabric \$2,159

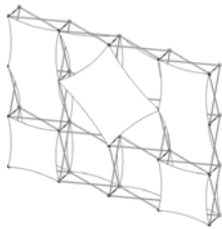

Configuration B
 Regular Fabric \$2,090
 Recycled Fabric \$2,214

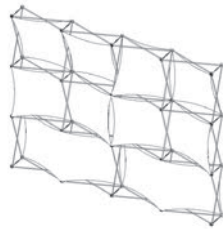

Configuration C
 Regular Fabric \$1,849
 Recycled Fabric \$1,949

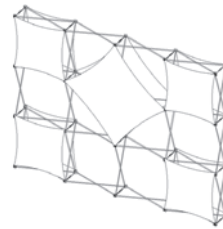

Configuration D
 Regular Fabric \$1,878
 Recycled Fabric \$1,981

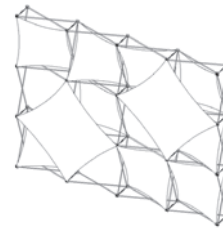

Configuration E
 Regular Fabric \$1,966
 Recycled Fabric \$2,078

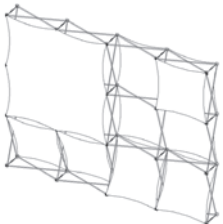

Configuration F
 Regular Fabric \$1,890
 Recycled Fabric \$1,944

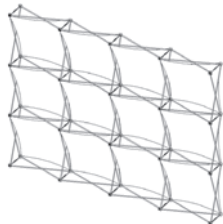

Configuration G
 Regular Fabric \$1,906
 Recycled Fabric \$2,012

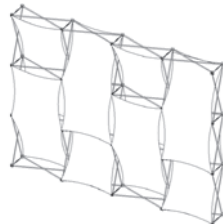

Configuration H
 Regular Fabric \$2,144
 Recycled Fabric \$2,274

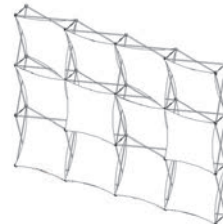

Configuration I
 Regular Fabric \$1,977
 Recycled Fabric \$2,090

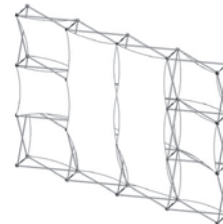

Configuration J
 Regular Fabric \$1,967
 Recycled Fabric \$2,079

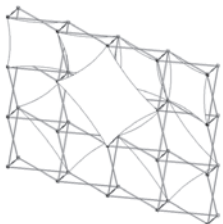

Configuration K
 Regular Fabric \$1,687
 Recycled Fabric \$1,771

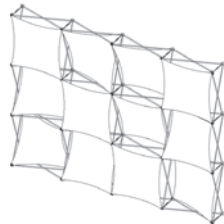

Configuration L
 Regular Fabric \$1,906
 Recycled Fabric \$2,012

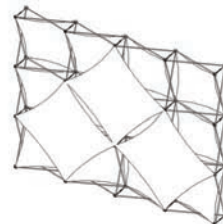

Configuration M
 Regular Fabric \$2,308
 Recycled Fabric \$2,454

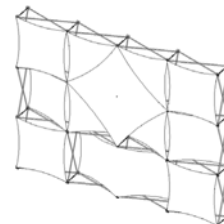

Configuration N
 Regular Fabric \$2,054
 Recycled Fabric \$2,175

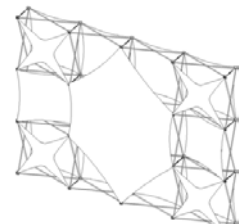

Configuration O
 Regular Fabric \$2,887
 Recycled Fabric \$3,091

- See Xpressions[®] SNAP![™] Accessories Pricing on Page PF - 20

- See Xpressions[®] SNAP![™] A La Carte Graphic Wholesale Pricing on Page PF - 22

xpressions[®]SNAP![™] 4 x 3 US

Xpressions[®] SNAP![™] ... the ultimate in frame-graphic technology! Create a stunning 3-dimensional display to increase your sales ... in a SNAP![™] Twelve standard frames, two planes for integrated graphics, and infinite configurations, offer you a visual playground to create dramatic effects. Xpressions[®] offers endless design possibilities! The Xpressions[®] frame is shipped with the fabric skins fully attached. The portable, lightweight frame makes your display set-up a SNAP![™] No tools or event labor required. Simply grasp with both hands evenly the right and left side of the center quad within the frame, then gently lift upward. Strong magnetic connectors "SNAP" lock the frame automatically within seconds! The versatility of this frame allows you to change graphics in the field easily creating a totally fresh display. The Xpressions[®] SNAP![™] is truly unlike any display! Let your imagination flow and watch your sales soar! Your message deserves the best ... Beware of the imitators, provide your customers with the authentic original Xpressions[®] SNAP![™] and benefit from it's no questions asked lifetime frame warranty!

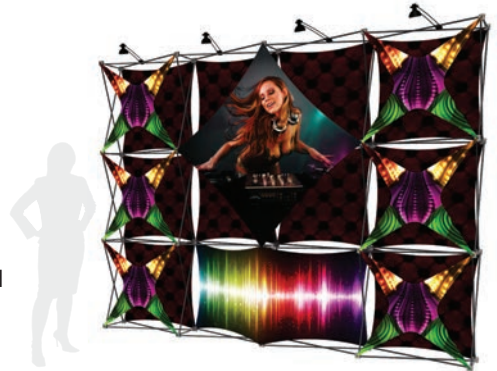

4x3 US XSnap[™] (P)
 Regular Fabric \$2,583
 Open Dim. 117.5"w x 89.5"h

4 x 3 US Kits

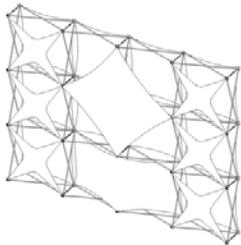

Configuration P
 Regular Fabric \$2,583
 Recycled Fabric \$2,757

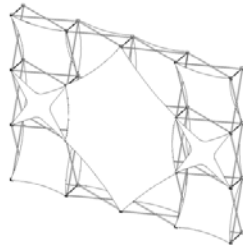

Configuration Q
 Regular Fabric \$2,330
 Recycled Fabric \$2,479

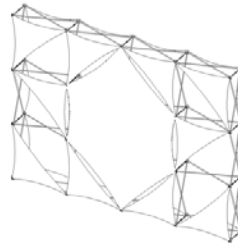

Configuration R
 Regular Fabric \$2,942
 Recycled Fabric \$3,152

xpressions® SNAP!™ 5 Quad X

Xpressions® SNAP!™ ... the ultimate in frame-graphic technology! Create a stunning 3-dimensional display to increase your sales ... in a SNAP!™ Twelve standard frames, two planes for integrated graphics, and infinite configurations, offer you a visual playground to create dramatic effects. Xpressions® offers endless design possibilities! The Xpressions® frame is shipped with the fabric skins fully attached. The portable, lightweight frame makes your display set-up a SNAP!™ No tools or event labor required. Simply grasp with both hands evenly the right and left side of the center quad within the frame, then gently lift upward. Strong magnetic connectors “SNAP” lock the frame automatically within seconds! The versatility of this frame allows you to change graphics in the field easily creating a totally fresh display. The Xpressions® SNAP!™ is truly unlike any display! Let your imagination flow and watch your sales soar! Your message deserves the best ... Beware of the imitators, provide your customers with the authentic original Xpressions® SNAP!™ and benefit from it's no questions asked lifetime frame warranty!



5 Quad X XSnap™ (I)
Regular Fabric \$1,165
Open Dim. 90”w x 88”h

5 Quad X Metric Kits

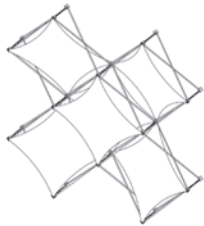

Configuration A
Regular Fabric \$929
Recycled Fabric \$982

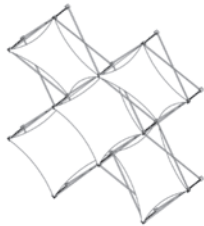

Configuration B
Regular Fabric \$841
Recycled Fabric \$885

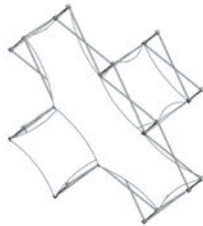

Configuration C
Regular Fabric \$852
Recycled Fabric \$897

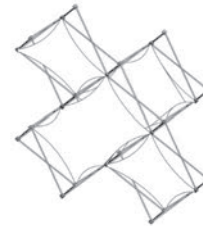

Configuration D
Regular Fabric \$900
Recycled Fabric \$950

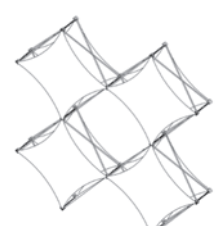

Configuration E
Regular Fabric \$1,106
Recycled Fabric \$1,177

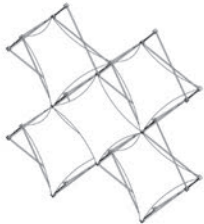

Configuration F
Regular Fabric \$841
Recycled Fabric \$885

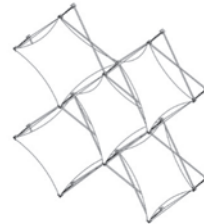

Configuration G
Regular Fabric \$841
Recycled Fabric \$885



Configuration H
Regular Fabric \$1,077
Recycled Fabric \$1,145

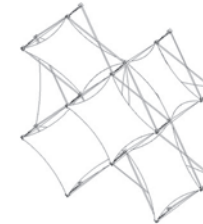

Configuration I
Regular Fabric \$1,165
Recycled Fabric \$1,242



Configuration J
Regular Fabric \$1,158
Recycled Fabric \$1,234

- See Xpressions® SNAP!™ Accessories Pricing on Page PF - 20
- See Xpressions® SNAP!™ A La Carte Graphic Wholesale Pricing on Page PF - 22

xpressions[®]SNAP![™] 6 Quad Pyramid

Xpressions[®]SNAP![™] ... the ultimate in frame-graphic technology! Create a stunning 3-dimensional display to increase your sales ... in a SNAP![™] Twelve standard frames, two planes for integrated graphics, and infinite configurations, offer you a visual playground to create dramatic effects. Xpressions[®] offers endless design possibilities! The Xpressions[®] frame is shipped with the fabric skins fully attached. The portable, lightweight frame makes your display set-up a SNAP![™] No tools or event labor required. Simply grasp with both hands evenly the right and left side of the center quad within the frame, then gently lift upward. Strong magnetic connectors "SNAP" lock the frame automatically within seconds! The versatility of this frame allows you to change graphics in the field easily creating a totally fresh display. The Xpressions[®] SNAP![™] is truly unlike any display! Let your imagination flow and watch your sales soar! Your message deserves the best ... Beware of the imitators, provide your customers with the authentic original Xpressions[®] SNAP![™] and benefit from it's no questions asked lifetime frame warranty!



6 Quad Pyramid XSnap[™] (D)
Regular Fabric \$1,365
Open Dim. 134"w x 87.5"h

6 Quad Pyramid Kits

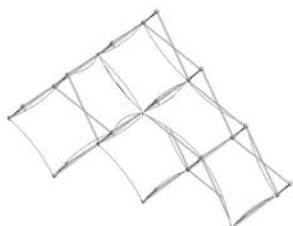

Configuration A
Regular Fabric \$1,176
Recycled Fabric \$1,226

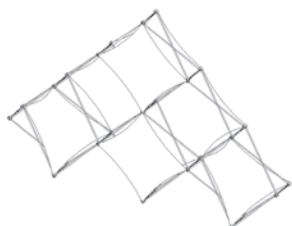

Configuration B
Regular Fabric \$1,329
Recycled Fabric \$1,394

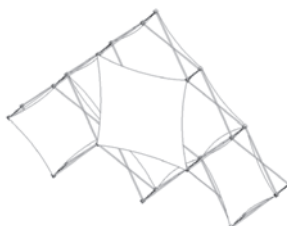

Configuration C
Regular Fabric \$1,315
Recycled Fabric \$1,379

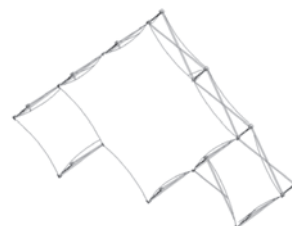

Configuration D
Regular Fabric \$1,365
Recycled Fabric \$1,434

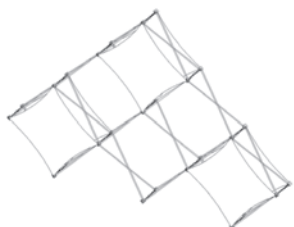

Configuration E
Regular Fabric \$1,205
Recycled Fabric \$1,258

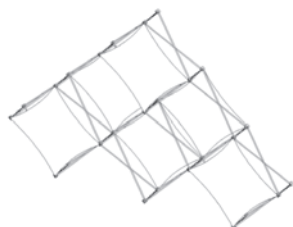

Configuration F
Regular Fabric \$1,205
Recycled Fabric \$1,258



Configuration G
Regular Fabric \$1,455
Recycled Fabric \$1,533

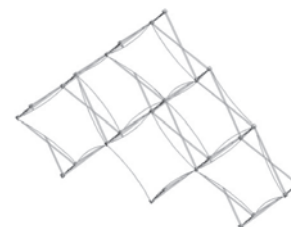

Configuration H
Regular Fabric \$1,205
Recycled Fabric \$1,258

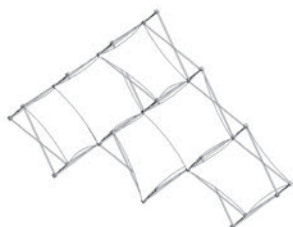

Configuration I
Regular Fabric \$1,205
Recycled Fabric \$1,258

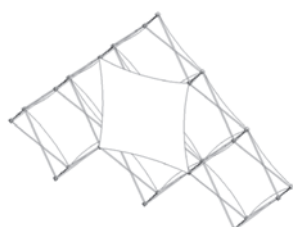

Configuration J
Regular Fabric \$1,367
Recycled Fabric \$1,436

- See Xpressions[®]SNAP![™] Accessories Pricing on Page PF - 20
- See Xpressions[®]SNAP![™] A La Carte Graphic Wholesale Pricing on Page PF - 22

xpressions[®]SNAP![™] 10 Quad Pyramid

Xpressions[®] SNAP![™] ... the ultimate in frame-graphic technology! Create a stunning 3-dimensional display to increase your sales ... in a SNAP![™] Twelve standard frames, two planes for integrated graphics, and infinite configurations, offer you a visual playground to create dramatic effects. Xpressions[®] offers endless design possibilities! The Xpressions[®] frame is shipped with the fabric skins fully attached. The portable, lightweight frame makes your display set-up a SNAP![™] No tools or event labor required. Simply grasp with both hands evenly the right and left side of the center quad within the frame, then gently lift upward. Strong magnetic connectors "SNAP" lock the frame automatically within seconds! The versatility of this frame allows you to change graphics in the field easily creating a totally fresh display. The Xpressions[®] SNAP![™] is truly unlike any display! Let your imagination flow and watch your sales soar! Your message deserves the best ... Beware of the imitators, provide your customers with the authentic original Xpressions[®] SNAP![™] and benefit from it's no questions asked lifetime frame warranty!



10 Quad Pyramid XSnap[™] (A)
 Regular Fabric \$1,939
 Open Dim. 178"w x 109.5"h

10 Quad Pyramid Kits

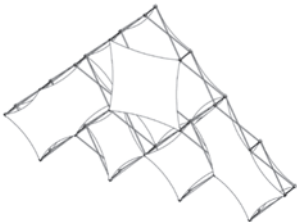

Configuration A
 Regular Fabric \$1,939
 Recycled Fabric \$2,053

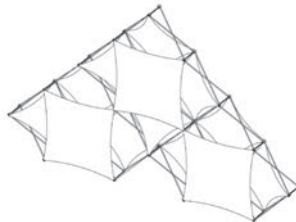

Configuration B
 Regular Fabric \$2,168
 Recycled Fabric \$2,305

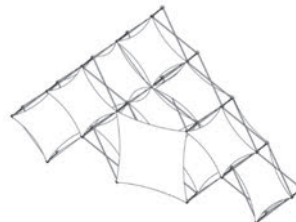

Configuration C
 Regular Fabric \$1,943
 Recycled Fabric \$2,057

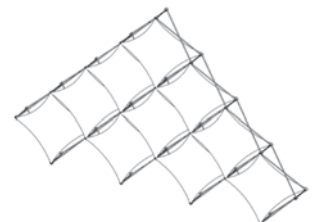

Configuration D
 Regular Fabric \$1,682
 Recycled Fabric \$1,770

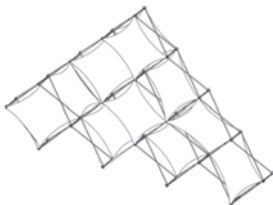

Configuration E
 Regular Fabric \$1,741
 Recycled Fabric \$1,835

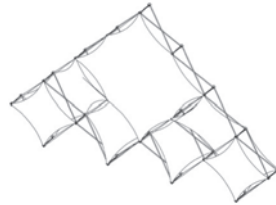

Configuration F
 Regular Fabric \$1,777
 Recycled Fabric \$1,875

- See Xpressions[®] SNAP![™] Accessories Pricing on Page PF - 20
- See Xpressions[®] SNAP![™] A La Carte Graphic Wholesale Pricing on Page PF - 22

xpressions® SNAP!™ 4 x 4

Xpressions® SNAP!™ ... the ultimate in frame-graphic technology! Create a stunning 3-dimensional display to increase your sales ... in a SNAP!™ Twelve standard frames, two planes for integrated graphics, and infinite configurations, offer you a visual playground to create dramatic effects. Xpressions® offers endless design possibilities! The Xpressions® frame is shipped with the fabric skins fully attached. The portable, lightweight frame makes your display set-up a SNAP!™ No tools or event labor required. Simply grasp with both hands evenly the right and left side of the center quad within the frame, then gently lift upward. Strong magnetic connectors "SNAP" lock the frame automatically within seconds! The versatility of this frame allows you to change graphics in the field easily creating a totally fresh display. The Xpressions SNAP!™ is truly unlike any display! Let your imagination flow and watch your sales soar! Your message deserves the best ... Beware of the imitators, provide your customers with the authentic original Xpressions® SNAP!™ and benefit from it's no questions asked lifetime frame warranty!



4 x 4 XSnap™ (A)
 Regular Fabric \$2,393
 Open Dim. 125"w x 125"h

4 x 4 Kits

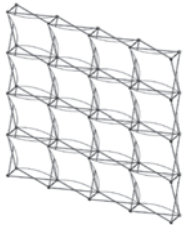

Configuration A
 Regular Fabric \$2,393
 Recycled Fabric \$2,534

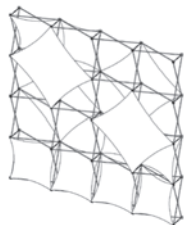

Configuration B
 Regular Fabric \$2,336
 Recycled Fabric \$2,471

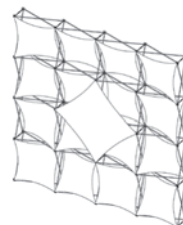

Configuration C
 Regular Fabric \$2,555
 Recycled Fabric \$2,712

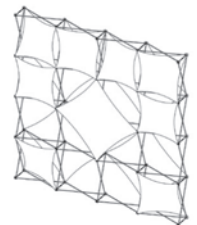

Configuration D
 Regular Fabric \$2,498
 Recycled Fabric \$2,650

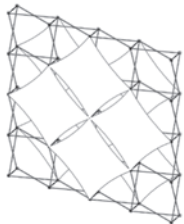

Configuration E
 Regular Fabric \$2,440
 Recycled Fabric \$2,586

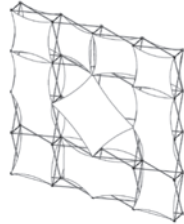

Configuration F
 Regular Fabric \$2,559
 Recycled Fabric \$2,617

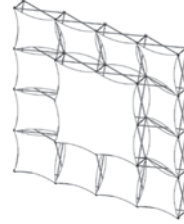

Configuration G
 Regular Fabric \$2,341
 Recycled Fabric \$2,477

- See Xpressions® SNAP!™ Accessories Pricing on Page PF - 20
- See Xpressions® SNAP!™ A La Carte Graphic Wholesale Pricing on Page PF - 22

xpressions[®]SNAP![™] Argyle

Xpressions[®] SNAP![™] ... the ultimate in frame-graphic technology! Create a stunning 3-dimensional display to increase your sales ... in a SNAP![™] Twelve standard frames, two planes for integrated graphics, and infinite configurations, offer you a visual playground to create dramatic effects. Xpressions[®] offers endless design possibilities! The Xpressions[®] frame is shipped with the fabric skins fully attached. The portable, lightweight frame makes your display set-up a SNAP![™] No tools or event labor required. Simply grasp with both hands evenly the right and left side of the center quad within the frame, then gently lift upward. Strong magnetic connectors "SNAP" lock the frame automatically within seconds! The versatility of this frame allows you to change graphics in the field easily creating a totally fresh display. The Xpressions SNAP![™] is truly unlike any display! Let your imagination flow and watch your sales soar! Your message deserves the best ... Beware of the imitators, provide your customers with the authentic original Xpressions[®] SNAP![™] and benefit from it's no questions asked lifetime frame warranty!



Argyle XSnap[™] (A)
 Regular Fabric \$1,529
 Open Dim. 133" w x 88" h

Argyle Kits

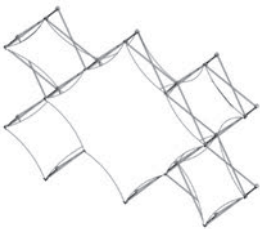

Configuration A
 Regular Fabric \$1,529
 Recycled Fabric \$1,618

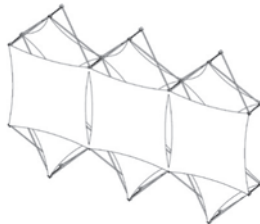

Configuration B
 Regular Fabric \$1,655
 Recycled Fabric \$1,757

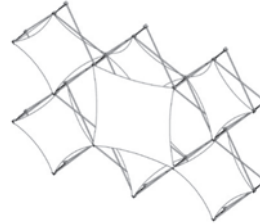

Configuration C
 Regular Fabric \$1,331
 Recycled Fabric \$1,400

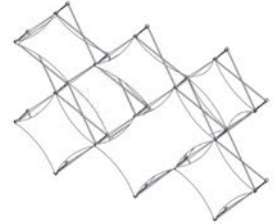

Configuration D
 Regular Fabric \$1,455
 Recycled Fabric \$1,537

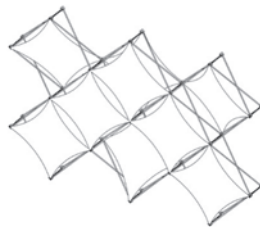

Configuration E
 Regular Fabric \$1,434
 Recycled Fabric \$1,513

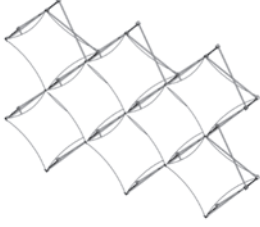

Configuration F
 Regular Fabric \$1,346
 Recycled Fabric \$1,417

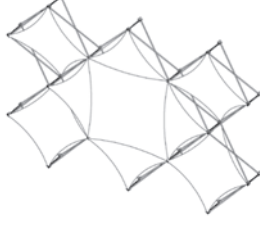

Configuration G
 Regular Fabric \$1,508
 Recycled Fabric \$1,595

- See Xpressions[®] SNAP![™] Accessories Pricing on Page PF - 20
- See Xpressions[®] SNAP![™] A La Carte Graphic Wholesale Pricing on Page PF - 22

xpressions[®]SNAP![™] Projector

Xpressions[®] SNAP![™] ... the ultimate in frame-graphic technology! Create a stunning 3-dimensional display to increase your sales ... in a SNAP![™] Twelve standard frames, two planes for integrated graphics, and infinite configurations, offer you a visual playground to create dramatic effects. Xpressions[®] offers endless design possibilities! The Xpressions[®] frame is shipped with the fabric skins fully attached. The portable, lightweight frame makes your display set-up a SNAP![™] No tools or event labor required. Simply grasp with both hands evenly the right and left side of the center quad within the frame, then gently lift upward. Strong magnetic connectors "SNAP" lock the frame automatically within seconds! The versatility of this frame allows you to change graphics in the field easily creating a totally fresh display. The Xpressions SNAP![™] is truly unlike any display! Let your imagination flow and watch your sales soar! Your message deserves the best ... Beware of the imitators, provide your customers with the authentic original Xpressions[®] SNAP![™] and benefit from it's no questions asked lifetime frame warranty!



Projector XSnap[™] (C)
 Regular Fabric \$3,111
 Open Dim. 186" w x 125" h

Projector Kits*

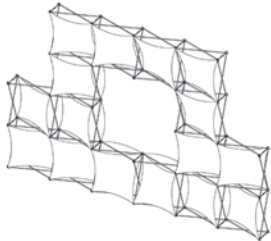

Configuration A
 Regular Fabric \$2,992
 Recycled Fabric \$3,163

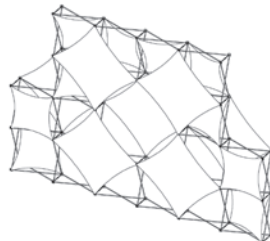

Configuration B
 Regular Fabric \$3,296
 Recycled Fabric \$3,498

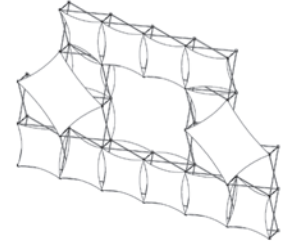

Configuration C
 Regular Fabric \$3,111
 Recycled Fabric \$3,294

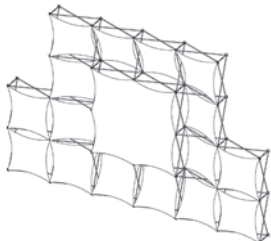

Configuration D
 Regular Fabric \$2,992
 Recycled Fabric \$3,163

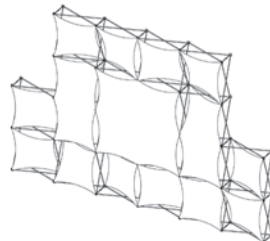

Configuration E
 Regular Fabric \$2,963
 Recycled Fabric \$3,131

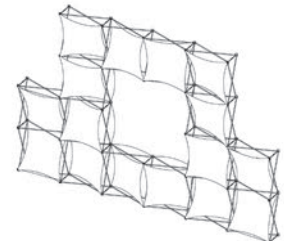

Configuration F
 Regular Fabric \$2,963
 Recycled Fabric \$3,131

- See Xpressions[®] SNAP![™] Accessories Pricing on Page PF - 20
- See Xpressions[®] SNAP![™] A La Carte Graphic Wholesale Pricing on Page PF - 22

* Projector frames require two people for proper set-up.

xpressions[®]SNAP![™] Accessories



Canvas Bag
Black canvas w/ handles;
Weight: 3.2 lbs. (w/o graphic)
Dim: 35" w x 10" d x 9" h
Price.....\$48 ea.



Hard Case w/ Wheels
Holds up to 20' of display,
Ex. one 3x3, two 2x3 and one 2x2;
Weight: 12.8 lbs. (w/o graphic)
Dim: outside - 14" w x 14" d x 41" h
inside - 13" w x 13" d x 35" h
Price.....\$144 ea.



Please specify if you have a US Xpressions Snap unit. Price is the same for a US and non-US units but size is slightly different.



Circle Shelves
Dim: 12" dia. 3/16" thick
Colors: black and silver
Price.....\$15 ea.



Shelves
Colors: black & white
Price.....\$42 ea.



Stabilizing Feet
Colors: black and silver
Price.....\$45 set of two.

Lightbox
1x1 Quad size only
Lightbox has 35 Led Lights
Color: White
Weight: 2 lbs. w/transformer)
Dim: 28" w x 5" d x 28" h
Price.....\$255 ea.

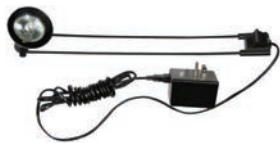

Light
50 watt halogen
w/attachment clip;
Colors: black or silver
Price.....\$59 ea.



Universal BCL light;
35 watt halogen
available in silver ...\$55 ea.



Light Bag
Black canvas w/ handles;
holds 2 lights
Price.....\$30 ea.



Connex shelf
Color: Black
Weight: 1.25 lbs.
Holds: 10lbs per shelf
• Trapezoid Dim: 29" x 8.75" x 1"
• Square Dim: 12" x 12" x 1"
Price.....\$44 ea. (either shelf)
• Rectangle Dim: 29" x 12" x 1"
Price.....\$42 ea.



LED Pop-up Light;
available in black\$88 ea.



Wire Management Clip
Small black cable clip to attach to Xsnap[™] frame and hold light wires.
Color: Black
Price.....\$5 / box of 12

Counters & Workstations



Xsnap[™] counter
Finished graphic size: 50" w x 30" h
Front image size: 30" w x 30" h
Focus area: 12" square in center.
Weight: 6.25 lbs.
Dim: open - 35" w x 12.75" d x 35" h
closed - 3.5" w x 4" d x 36" h
Counter Top: 35" w x 1" d x 13" h
(Center of counter top holds up to 11lbs.)
components:
- Graphic.....\$163
- Counter top....\$45
- Frame\$96
Total Price.....\$304 ea.

Inside bottom shelf
(optional).....\$45

Xpressions[®] 223 Counter & Workstation



For more details go to page T5.

Xpressions® Frame Dimensions Chart

	xpressions [®] SNAP! [™]	xpressions [®]	xpressions [®] SALES [™] MATE
Open Dimensions			
Frame Type	W x H x D	W x H x D	W x H x D
1x3	32.25" x 94" x 12.75"	31" x 92" x 13"	N/A
2x2	63" x 63.25" x 12.75"	60" x 62" x 13"	31" x 31" x 9.25"
2x3	63" x 94" x 12.75"	60" x 92" x 13"	N/A
3x3	93.5" x 94" x 12.75"	119" x 92" x 13"	45.75" x 45.75" x 9.25"
4x3 US	117.5" x 89.5" x 13"	128" x 84" x 13"	N/A
4x3 Metric	124.5" x 94" x 12.75"	N/A	60.5" x 45.75" x 9.25"
6 Quad Pyramid	134" x 87.5" x 12.75"	N/A	N/A
5 Quad X	90" x 88" x 12.75"	N/A	N/A
3 Quad Pyramid	90" x 66" x 12.75"	N/A	43.875" x 33.125" x 9.25"
Argyle	133" x 88" x 12.75"	N/A	N/A
10 Quad Pyramid	178" x 109.5" x 12.75"	N/A	N/A
4x4	125" x 125" x 12.75"	N/A	N/A
Projector	186" x 125" x 12.75"	N/A	N/A
Closed Dimensions (without skins)			
Frame Type	W x L x H	W x L x H	W x L x H
1x3	3.5" x 7" x 33.75"	3.5" x 6" x 33"	N/A
2x2	6" x 6" x 33.75"	4.5" x 4.5" x 33"	5" x 5" x 17.5"
2x3	6" x 7" x 33.75"	4.5" x 6" x 33"	N/A
3x3	7" x 7" x 33.73"	6" x 6" x 33"	6.25" x 6.25" x 17.5"
4x3 US	10" x 9" x 32.5"	7" x 6" x 33"	N/A
4x3 Metric	10" x 7" x 33.75"	N/A	9.5" x 8" x 17.5"
6 Quad Pyramid	7" x 7" x 33.75"	6" x 6" x 33"	N/A
5 Quad X	6.5" x 6.5" x 33.75"	N/A	N/A
3 Quad Pyramid	5" x 5" x 33.75"	N/A	5" x 5" x 17.5"
Argyle	8.5" x 6" x 33.75"	13" x 13" x 35"	N/A
10 Quad Pyramid	8" x 8" x 33.75"	N/A	N/A
4x4	8" x 8" x 33.75"	N/A	N/A
Projector	11" x 8" x 33.75"	N/A	N/A
Frame Weights (without skins)			
Frame Type	Weight	Weight	Weight
1x3	5.50 Lbs.	5.0 Lbs.	N/A
2x2	7.0 Lbs.	6.50 Lbs.	2.85 Lbs.
2x3	9.50 Lbs.	8.50 Lbs.	N/A
3x3	12.50 Lbs.	12.0 Lbs.	5.55 Lbs.
4x3 US	15.50 Lbs.	15.0 Lbs.	N/A
4x3 Metric	17.0 Lbs.	N/A	6.5
6 Quad Pyramid	9.50 Lbs.	10.0 Lbs.	N/A
5 Quad X	9.0 Lbs.	N/A	N/A
3 Quad Pyramid	5.50 Lbs.	N/A	2.45 Lbs.
Argyle	13.0 Lbs.	N/A	N/A
10 Quad Pyramid	14.50 Lbs.	N/A	N/A
4x4	21.0 Lbs.	N/A	N/A
Projector	25.0 Lbs.	N/A	N/A

xpressions[®]SNAP![™]

Regular & sheer graphic skins

A La Carte Graphic Wholesale Pricing

SKINS (Recycled Fabric-add 10% to the sum of the cost of the graphics.)	
Size	Price
1x1	\$98
1x2	\$180
1x3	\$251
2x1	\$180
2x2	\$334
3x2	\$447
3x3	\$588
4x3 US	\$672
Diamond	\$180
2x3	\$447
3x1	\$251
4x1	\$334
Triangle Flat	\$67
Triangle Thread	\$67
Star	\$98
Hex	\$447
CONNEX Connector Skins	
1x1 Rectangle	\$48
1x2 Rectangle	\$96
1x3 Rectangle	\$144
1x1 Hourglass	\$98
1x2 Hourglass	\$180
1x3 Hourglass	\$251
1x1 Wide	\$98
1x2 Wide	\$180
1x3 Wide	\$251
Backlit Skin*	
1x1	\$108
1x3	\$267

* Backlit Skin only available as 1x1 & 1x3 - It is recommended that the backlit skin is removed from frame during storage and placed on the supplied cardboard core to avoid wrinkles. Shipping the skin on the supplied cardboard core is also recommended.

NOTE: Predyed Xpressions[®] skins available. Call for quote.

Back Covers (available colors: white, black, blue (PMS 287c) and green (PMS 341c))		
Frame Size	Pre Dyed Fabric Price	Dye Sub Price
1x3	\$75	\$251
2x2	\$85	\$334
2x3	\$125	\$447
3x3	\$195	\$588
4x3 US	\$225	\$672
Pyramid	\$205	\$605
3 Quad Pyramid	\$85	\$334
10 Quad Pyramid	\$400	\$1,500
Argyle	\$285	\$900
Projector	\$550	\$1,975
3x4	\$400	\$1,500
5 Quad X	\$225	\$610

Frames	
Size	Price
1x3	\$236
2x2	\$330
2x3	\$462
3x3	\$676
4x3 US	\$848
Pyramid	\$676
4x4	\$982
3 Quad Pyramid	\$240
10 Quad Pyramid	\$800
5 Quad X	\$400
Argyle	\$640
Projector	\$1,280

Duplicate Discounts	
Qty	Discount Factor (frame & graphic skins)
1	1.0
2-5	.97
6-10	.96
11-15	.95
16-25	.94
50+	Please Request A Quote
Graphic Kits	
Deduct 10% from the sum of the cost of the graphics in that kit.	

PushThru Skins	
Size	Price
1x3 Thin	\$188
1x3 Wide	\$276
1x1 Triangle	\$61
1x2 Triangle	\$122
1x3 Triangle	\$183

LED Lightbox	
Please specify if you have a US Xpressions Snap unit. Price is the same for a US and non-US unit but size is slightly different.	
1x1 for XSnap	\$255
1x3 for CONNEX	\$780



Sheer skin costs are the same as regular skins pricing.

xpressions[®]

LED LIGHTBOX

Pull your Xpressions@SNAP display from its case and pop it up! A complete display in less than a minute. But wait, what's this? One more step? Plug it in? That's right, when you outfit your Xpressions@SNAP!™ display with one or more LED LightBoxes there is one more simple step!

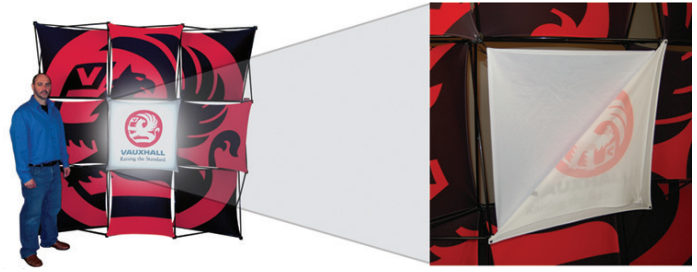

Xpressions[®] has been turning heads, pulling in booth traffic and defining event spaces all in a complete hassle-free package since its debut. Now add the power of light to add attention at trade shows and create ambiance at events.

Your display remains hassle-free as the LED LightBox is already installed on the frame.

Snap 1x3 w/Lightbox

- Frame & Graphics \$530
 - 1 x 1 skin (3)
- 50 watt halogen lights (1) \$59
- LightBox (2) \$510
- Total Price \$1,099**

Total Price with two optional Backlit graphic skins* \$1,119

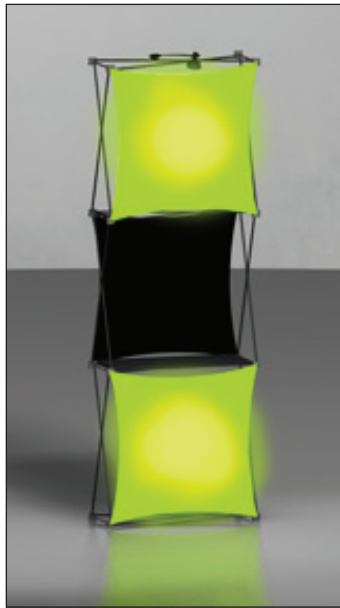

Dimensions

Open: 32.25"W x 94"H x 12.75"D
 Closed: 3.5"W x 7"L x 33.75"H

Kit Weight

25 lbs.

Snap 2x3 w/Lightbox

- Frame & Graphics \$1,050
 - 1 x 1 skin (6)
- 50 watt halogen lights (1) \$118
- LightBox (2) \$510
- Total Price \$1,678**

Total Price with two optional Backlit graphic skins* \$1,698

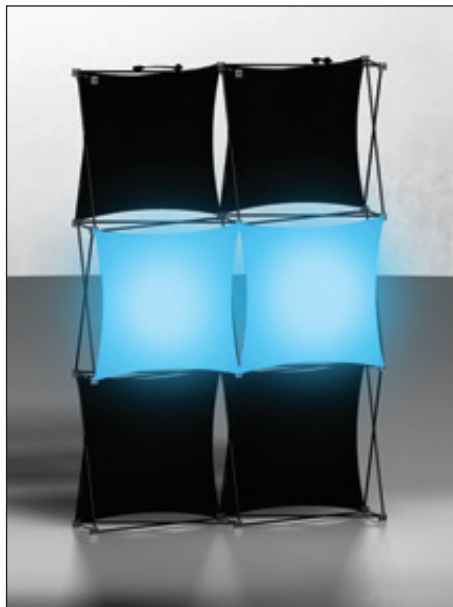

Dimensions

Open: 63"W x 94"H x 12.75"D
 Closed: 6"W x 7"L x 33.75"H

Kit Weight

33 lbs.

* Backlit Skin only available as 1x1 - It is recommended that the backlit skin is removed from frame during storage and placed on the supplied cardboard core to avoid wrinkles. Shipping the skin on the supplied cardboard core is also recommended.

xpressions®

LED LIGHTBOX

Pull your Xpressions®SNAP display from it's case and pop it up! A complete display in less than a minute. But wait, what's this? One more step? Plug it in? That's right, when you outfit your Xpressions®SNAP!™ display with one or more LED LightBoxes there is one more simple step!

Xpressions® has been turning heads, pulling in booth traffic and defining event spaces all in a complete hassle-free package since its debut. Now add the power of light to add attention at trade shows and create ambiance at events.

Your display remains hassle-free as the LED LightBox is already installed on the frame.

HIGHLIGHT YOUR MESSAGE OR BRAND!

Snap 3x3M w/Lightbox

- Frame & Graphics \$1,558
 - 1 x 1 skin (9)
- LightBox (1) \$255
- Total Price \$1,813**

**Total Price with one optional
Backlit graphic skin* \$1,823**



Dimensions

Open: 93.5"W x 94"H x 12.75"D
Closed: 7"W x 7"L x 33.75"H

Kit Weight

42 lbs.

CREATE BACKDROPS AND ENVIRONMENTS!

Snap 3x3 w/Lightbox

- Frame & Graphics \$1,558
 - 1 x 1 skin (9)
- 50 watt halogen lights (3) \$177
- LightBox (5) \$1,275
- Total Price \$3,010**

**Total Price with five optional
Backlit graphic skins* \$3,060**



Dimensions

Open: 93.5"W x 94"H x 12.75"D
Closed: 7"W x 7"L x 33.75"H

Kit Weight

42 lbs.

CHANGE YOUR MESSAGE OR COLOR EVERYDAY OF THE SHOW!

* Backlit Skin only available as 1x1 - It is recommended that the backlit skin is removed from frame during storage and placed on the supplied cardboard core to avoid wrinkles. Shipping the skin on the supplied cardboard core is also recommended.

xpressions[®] express[™]

Xpressions[®] express[™] is the revolutionary compact solution for your trade show display needs. Smartly packed in the super durable rolling case is an entire display. Express[™] makes it easy to go where your customers are. The case quickly transforms into a podium with a huge

graphic face for maximum branding exposure. Within minutes your entire display will be up and looking great. Unpack the two included 1x3 Xpressions[®] SNAP[™] units, depending on your kit choice the two units will be linked by two shelves and Xpressions[®] fabric graphic skins.

The collective result is a fantastic looking 8' display with large podium, perfect for any 10' x 10' show space!

The express[™] podium is as attractive as it is functional, lift the hard writing surface to reveal a spacious storage cubby. The podium holds specialty items and show giveaways, literature and more. Xpressions[®] has become one of the most sought after display options on the market, the express[™] kits really do take the original Xpressions[®] on the go! When the show ends your entire display will break down and pack neatly into the travel case. Within minutes you will be on your way!

See line drawing next to render in top right corner for shelf placement, **Red line indicates shelves.**

Pricing

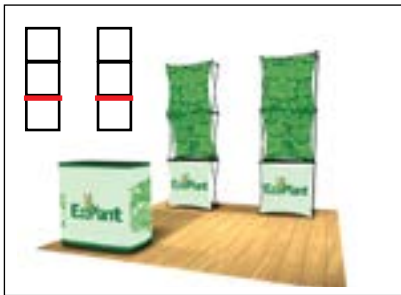

Kit A -

- Two 1x3 Xpressions[®] SNAP[™] frames
- Four Xpressions[®] skins (Two 1x1 & Two 1x2 skins)
- Two Shelves
- One case wrap
- Case that converts to podium

\$1,592 Wholesale cost
Recycled fabric option
\$1,670 Wholesale cost

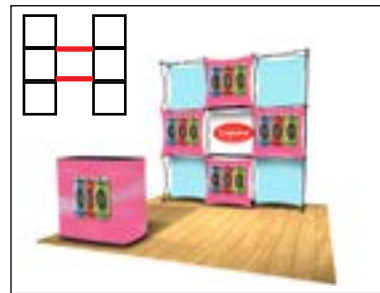

Kit B -

- Two 1x3 Xpressions[®] SNAP[™] frames
- Nine Xpressions[®] skins (Nine 1x1 skins)
- Two Shelves
- One case wrap
- Case that converts to podium

\$1,914 Wholesale cost
Recycled fabric option
\$2,016 Wholesale cost

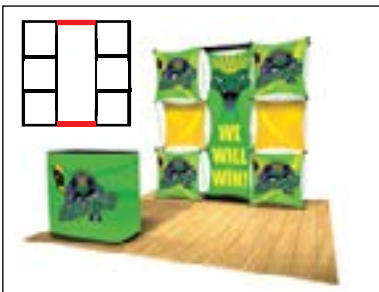

Kit C - As Shown

- Kit Includes:
- Two 1x3 Xpressions[®] SNAP[™] frames
 - Seven Xpressions[®] skins (Six 1x1 & One 1x3 skins)
 - Two Shelves
 - One case wrap
 - Case that converts to podium

\$2,090 Wholesale cost
Recycled fabric option
\$2,210 Wholesale cost

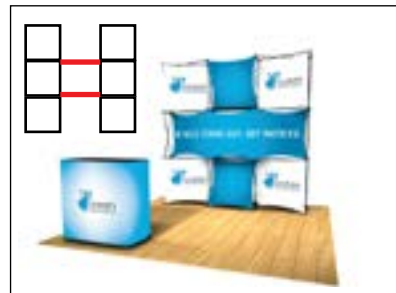

Kit D -

- Two 1x3 Xpressions[®] SNAP[™] frames
- Seven Xpressions[®] skins (One 3x1 & Six 1x1 skins)
- Two Shelves
- One case wrap
- Case that converts to podium

\$2,090 Wholesale cost
Recycled fabric option
\$2,210 Wholesale cost

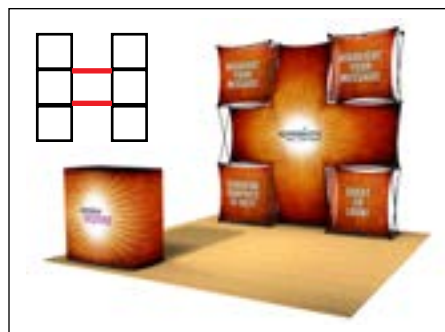

Kit E -

- Two 1x3 Xpressions[®] SNAP[™] frames
- Two Included rectangular connecting shelves
- Nine Xpressions[®] skins (Eight 1x1 & one Plus skins)
- One Lightbox
- One case wrap
- Case that converts to podium

\$2,553 Wholesale cost
Recycled fabric option
\$2,671 Wholesale cost

xpressions[®] express[™]

Specifications

Express Case

NOTE: The Express case is NOT A HARD SHIPPING CASE only a compact rolling travel case sturdy enough for typical airline checked baggage.

If you need to ship the Express case UPS or FedEx use the provided cardboard carton.



Easily transported to the show. Entire 10' display fits in this case.

Shipping Box

39"H x 19"D x 13"W

Shipping Weight

42 lbs.
(add 2 - 5 lbs. for box and packing)

Express[™] Case Dims:

Closed and packed: 38"H x 12"D x 18.5"W

Set-up: 34.25"H x 18.5"D x 37.25"W

Accessories

A la cart Pricing for Express[™]:

Regular/Sheer Graphic Skins (Recycled Fabric-add 10% to the sum of the cost of the graphics.)	
Skin Size	Price
1x1	\$98
1x2	\$180
1x3	\$251
2x1	\$180
2x2	\$334
3x2	\$447
3x3	\$588
Diamond	\$180
2x3	\$447
3x1	\$251
Plus	\$588

Duplicate pricing for Express[™] skins:

Duplicate Discounts	
Quantity	Discount Factor (frame & graphic skins)
1	1.0
2-5	.97
6-10	.96
11-15	.95
16-25	.94
Above 50	Please Request Quote

Xsnap Frame	Price
1x3	\$236

Express[™] case C2C replacement parts:

- Express[™] Case only \$220
- Counter Top only \$30
- Tambour w/ 2 Aluminum slide connectors \$90

Back Covers (available colors: white, black, blue (PMS 287c) and green (PMS 341c))

Frame Size	Pre Dyed Fabric Price	Dye Sub Price
1x3	\$75	\$251
2x2	\$85	\$334
2x3	\$125	\$447
3x3	\$195	\$588

Express[™] case sold without Xpressions[®] Snap[™] 1x3s:

- Express[™] Case including shell, tambour and top \$340
- Two Plastic Black Express[™] shelves \$80 set of two
- Dye Sub Fabric Graphic Cover .. \$200

Note: Connector skins have to be taken off frames for set-up and collapsing.

xpressions[®] CONNEX[™]

Xpressions@CONNEX™ transforms the Xpressions@SNAP™ pop-up into an exciting modular display system perfect for trade show or event environments. The key to unlocking your creativity is a simple innovation to the Xpressions@SNAP™ frame: a simple clip on the hub and the addition of a trapezoid and square connecting shelf along with the original rectangular shelf.

Connecting the frames at different angles or in straight lines adds yet another dimension to the Xpressions® exhibit. Dynamic connecting skins are used in combination with square, trapezoid or rectangular connecting shelves to create dramatic inline spaces, concave and convex configurations. Even create octagon islands for events.



10' x 10' Display Space
Display Dims: 76" w x 76" d x 94" h

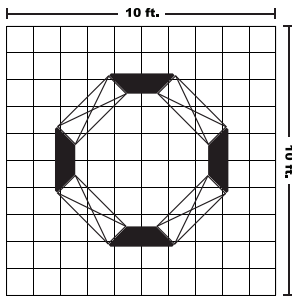

Connex Octagon A

- 4 - 1x3 Frames \$944
- 4 - 1x3 Flat skins \$1,004
- 4 - 1x3 Double Thread
- Hourglass skins \$1,004 (c)
- 8 - Trapezoid shelves \$352

Wholesale Total \$3,304

Fits in 2 Xpressions Shipping Cases.

Add for \$288

Wholesale Total with Cases \$3,592

Shipping Weight - 24lbs.

Add 2-5lbs. for box & packing



10' x 10' Display Space
Display Dims: 122" w x 13" d x 94" h

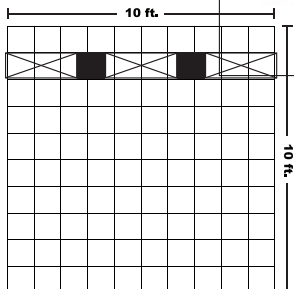

Connex 10' x 10' (A)

- 3 - 1x3 Frames \$708
- 3 - Lights \$177
- 3 - 1x1 Flat skins \$294
- 2 - 1x3 Flat Rectangle skins \$288 (c)
- 3 - 1x3 Single Thread skins \$753
- 4 - Square shelves \$176

Wholesale Total \$2,396

Fits in 1 Xpressions Shipping Case.

Add for \$144

Wholesale Total with Case \$2,540

Shipping Weight - 18lbs.

Add 2-5lbs. for box & packing

(c) Connector Skin

xpressions[®] CONNEX[™]

Xpressions@CONNEX™ transforms the Xpressions@SNAP™ pop-up into an exciting modular display system perfect for trade show or event environments. The key to unlocking your creativity is a simple innovation to the Xpressions@SNAP™ frame: a simple clip on the hub and the addition of a trapezoid and square connecting shelf along with the original rectangular shelf.

Connecting the frames at different angles or in straight lines adds yet another dimension to the Xpressions® exhibit. Dynamic connecting skins are used in combination with square, trapezoid or rectangular connecting shelves to create dramatic inline spaces, concave and convex configurations. Even create octagon islands for events.

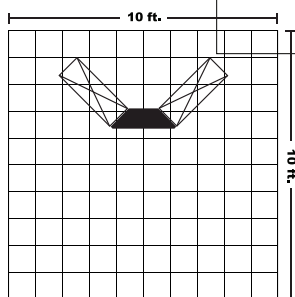

10' x 10' Display Space
Display Dims: 76" w x 30" d x 94" h

Connex 10' x 10' (B)

- 2 - 1x3 Frames \$472
- 2 - Lights \$118
- 6 - 1x1 Flat skins \$588
- 2 - Rectangle shelves \$84
- 1 - 1x3 Double Thread
- Hourglass skin \$251 (c)
- 2 - Trapezoid shelves \$88

Wholesale Total \$1,601

Fits in 1 Xpressions Shipping Cases.

Add for \$144

Wholesale Total with Case \$1,745

Shipping Weight - 12lbs.

Add 2-5lbs. for box & packing

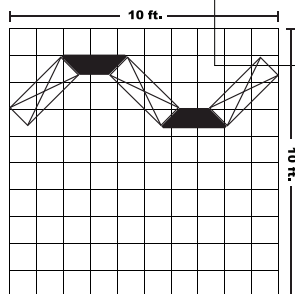

10' x 10' Display Space
Display Dims: 120" w x 30" d x 94" h

Connex 10' x 10' (C)

- 3 - 1x3 Frames \$708
- 3 - Lights \$177
- 3 - 1x3 Double Thread skins \$753
- 1 - 1x1 Flat skin \$98
- 1 - 1x3 Double Thread
- Hourglass skin..... \$251 (c)
- 1 - 1x3 Double Thread Wide skin .. \$251 (c)
- 4 - Trapezoid shelves \$176

Wholesale Total \$2,414

Fits in 1 Xpressions Shipping Case.

Add for \$144

Wholesale Total with Case \$2,558

Shipping Weight - 18lbs.

Add 2-5lbs. for box & packing

(c) Connector Skin

xpressions[®] CONNEX[™]

Xpressions@CONNEX[™] transforms the Xpressions@SNAP[™] pop-up into an exciting modular display system perfect for trade show or event environments. The key to unlocking your creativity is a simple innovation to the Xpressions@SNAP[™] frame: a simple clip on the hub and the addition of a trapezoid and square connecting shelf along with the original rectangular shelf.

Connecting the frames at different angles or in straight lines adds yet another dimension to the Xpressions@ exhibit. Dynamic connecting skins are used in combination with square, trapezoid or rectangular connecting shelves to create dramatic inline spaces, concave and convex configurations. Even create octagon islands for events.

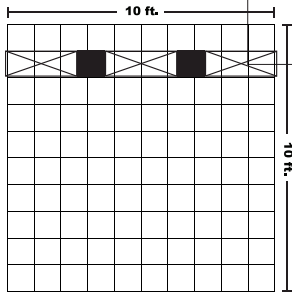

10' x 10' Display Space
Display Dims: 122" w x 13" d x 94" h

Connex 10' x 10' (D)

- 3 - 1x3 Frames \$708
- 3 - Lights \$177
- 1 - 1x1 Flat skin \$98
- 2 - 1x3 Flat Rectangle skins \$288 (c)
- 2 - 1x3 Flat skins \$502
- 1 - 1x3 Double Thread skin \$251
- 4 - Square shelves \$176

Wholesale Total \$2,200

Fits in 1 Xpressions Shipping Case.

Add for \$144

Wholesale Total with Case \$2,344

Shipping Weight - 18lbs.

Add 2-5lbs. for box & packing

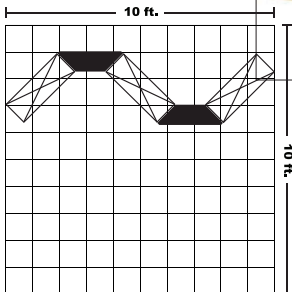

10' x 10' Display Space
120" w x 30" d x 94" h

Connex 10' x 10' (E)

- 3 - 1x3 Frames \$708
- 3 - Lights \$177
- 3 - 1x3 Flat skins \$753
- 2 - 1x3 Flat Rectangle skins \$395 (c)
- 4 - Trapezoid shelves \$176

Wholesale Total \$2,209

Fits in 1 Xpressions Shipping Case.

Add for \$144

Wholesale Total with Case \$2,353

Shipping Weight - 18lbs.

Add 2-5lbs. for box & packing

(c) Connector Skin

xpressions[®] CONNEX[™]

Xpressions@CONNEX™ transforms the Xpressions@SNAP™ pop-up into an exciting modular display system perfect for trade show or event environments. The key to unlocking your creativity is a simple innovation to the Xpressions@SNAP™ frame: a simple clip on the hub and the addition of a trapezoid and square connecting shelf along with the original rectangular shelf.

Connecting the frames at different angles or in straight lines adds yet another dimension to the Xpressions® exhibit. Dynamic connecting skins are used in combination with square, trapezoid or rectangular connecting shelves to create dramatic inline spaces, concave and convex configurations. Even create octagon islands for events.

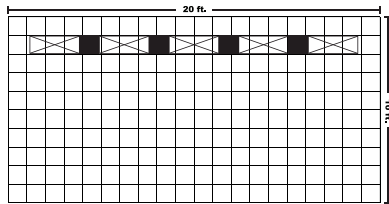

20' x 10' Display Space
Display Dims: 212" w x 13" d x 94" h

Connex 20' x 10' (A)

- 5 - 1x3 Frames \$1,180
- 5 - Lights \$295
- 2 - 1x3 Flat skins \$502
- 9 - 1x1 Flat skins \$882
- 4 - 1x3 Flat Rectangle skins \$576 (c)
- 8 - Square shelves \$352

Wholesale Total \$3,787

Fits in 2 Xpressions Shipping Cases.

Add for \$288

Wholesale Total with Cases \$4,075

Shipping Weight - 30lbs.

Add 2-5lbs. for box & packing

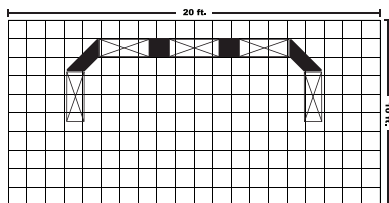

20' x 10' Display Space
Display Dims: 168" w x 54" d x 94" h

Connex 20' x 10' (B)

- 5 - 1x3 Frames \$1,180
- 5 - Lights \$295
- 3 - 1x3 Flat skins \$753
- 6 - 1x1 Flat skins \$588
- 4 - 1x3 Flat Rectangle skins ... \$576 (c)
- 4 - Square shelves \$176
- 2 - Rectangle shelves \$84
- 4 - Trapezoid shelves \$176

Wholesale Total \$3,828

Fits in 2 Xpressions Shipping Case.

Add for \$288

Wholesale Total with Cases ... \$4,116

Shipping Weight - 30lbs.

Add 2-5lbs. for box & packing

(c) Connector Skin

xpressions[®] CONNEX[™]

Xpressions@CONNEX™ transforms the Xpressions@SNAP™ pop-up into an exciting modular display system perfect for trade show or event environments. The key to unlocking your creativity is a simple innovation to the Xpressions@SNAP™ frame: a simple clip on the hub and the addition of a trapezoid and square connecting shelf along with the original rectangular shelf.

Connecting the frames at different angles or in straight lines adds yet another dimension to the Xpressions® exhibit. Dynamic connecting skins are used in combination with square, trapezoid or rectangular connecting shelves to create dramatic inline spaces, concave and convex configurations. Even create octagon islands for events.



Connex 20' x 10' (C)

- 4 - 1x3 Frames \$944
- 2 - 1x3 Double Thread
- Wide skins \$502 (c)
- 13 - 1x1 Flat skins \$1,274
- 1 - 1x3 Double Thread
- Hourglass skin \$251 (c)
- 6 - Trapezoid shelves \$264

Wholesale Total \$3,235

Fits in 2 Xpressions Shipping Cases.

Add for \$288

Wholesale Total with Cases \$3,523

Shipping Weight - 24lbs.

Add 2-5lbs. for box & packing

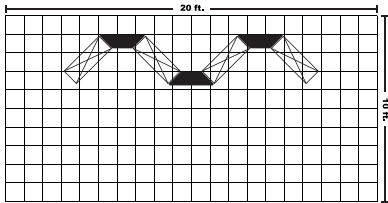

20' x 10' Display Space

Display Dims: 168" w x 34" d x 94" h



Connex 20' x 10' (D)

- 4 - 1x3 Frames \$944
- 2 - 1x3 Flat Double Thread
- Wide skins \$502 (c)
- 4 - 1x3 Double Thread skins \$1,004
- 1 - 1x1 Flat skin \$98
- 1 - 1x3 Double Thread
- Hourglass skin \$251 (c)
- 2 - Rectangle shelves \$84
- 6 - Trapezoid shelves \$264

Wholesale Total \$3,147

Fits in 2 Xpressions Shipping Cases.

Add for \$288

Wholesale Total with Cases \$3,435

Shipping Weight - 24lbs.

Add 2-5lbs. for box & packing

(c) Connector Skin

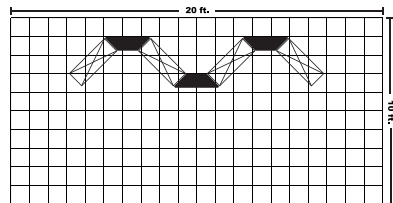

20' x 10' Display Space

Display Dims: 168" w x 34" d x 94" h

xpressions[®] CONNEX[™]

Xpressions@CONNEX™ transforms the Xpressions@SNAP™ pop-up into an exciting modular display system perfect for trade show or event environments. The key to unlocking your creativity is a simple innovation to the Xpressions@SNAP™ frame: a simple clip on the hub and the addition of a trapezoid and square connecting shelf along with the original rectangular shelf.

Connecting the frames at different angles or in straight lines adds yet another dimension to the Xpressions® exhibit. Dynamic connecting skins are used in combination with square, trapezoid or rectangular connecting shelves to create dramatic inline spaces, concave and convex configurations. Even create octagon islands for events.

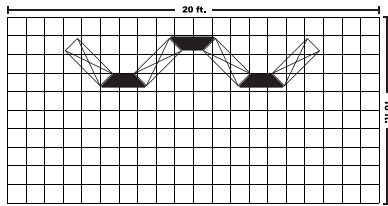

20' x 10' Display Space
Display Dims: 168" w x 34" d x 94" h

Connex 20' x 10' (E)

4 - 1x3 Frames	\$944
1 - 1x3 Flat Double Thread	
Wide skin	\$251 (c)
4 - 1x3 Flat skins	\$1,004
2 - 1x1 Flat skins	\$196
2 - 1x3 Double Thread	
Hourglass skins	\$502 (c)
6 - Trapezoid shelves	\$264

Wholesale Total \$3,161

Fits in 2 Xpressions Shipping Cases.
Add for \$288
Wholesale Total with Cases \$3,449

Shipping Weight - 24lbs.
Add 2-5lbs. for box & packing

(c) Connector Skin

xpressions[®] CONNEX[™]

Xpressions@CONNEX™ transforms the Xpressions@SNAP™ pop-up into an exciting modular display system perfect for trade show or event environments. The key to unlocking your creativity is a simple innovation to the Xpressions@SNAP™ frame: a simple clip on the hub and the addition of a trapezoid and square connecting shelf along with the original rectangular shelf.

Connecting the frames at different angles or in straight lines adds yet another dimension to the Xpressions® exhibit. Dynamic connecting skins are used in combination with square, trapezoid or rectangular connecting shelves to create dramatic inline spaces, concave and convex configurations. Even create octagon islands for events.

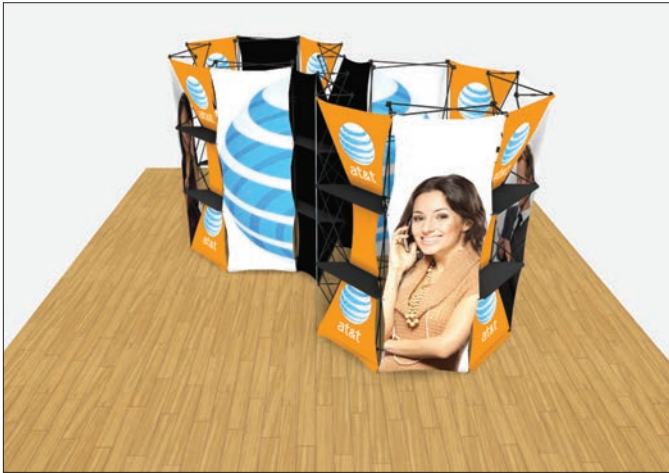

Connex 20' x 20' Island (A)

- 8 - 1x3 Frames \$1,888
- 8 - 1x3 Flat skins \$2,008
- 6 - 1x3 Double Thread
- Hourglass skins \$1,506 (c)
- 2 - 1x3 Flat Double Thread
- Wide skins \$502 (c)
- 16 - Trapezoid shelves \$704

Wholesale Total \$6,608

Fits in 3 Xpressions Shipping Cases.

Add for \$432

Wholesale Total with Cases ... \$7,040

Shipping Weight - 48lbs.

Add 2-5lbs. for box & packing

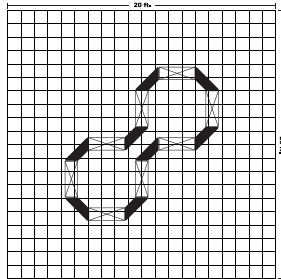

20' x 20' Display Space
Display Dims: 144" w x 144" d x 94" h

Connex 20' x 20' Island (B)

- 12 - 1x3 Frames \$2,832
- 12 - 1x3 Flat skins \$3,004
- 8 - 1x3 Double Thread
- Hourglass skins \$2,008 (c)
- 24 - Trapezoid shelves \$1,056
- 4 - 1x3 Double Thread
- Wide skins \$1,004 (c)

Wholesale Total \$9,904

Fits in 4 Xpressions Shipping Cases.

Add for \$576

Wholesale Total with Cases \$10,480

Shipping Weight - 72lbs.

Add 2-5lbs. for box & packing

(c) Connector Skin

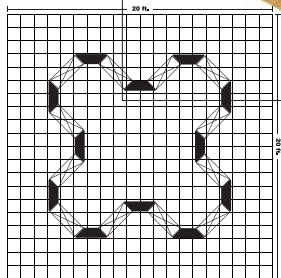
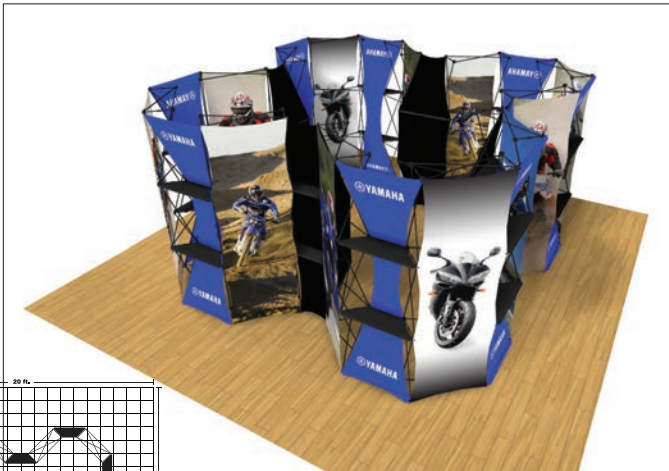

20' x 20' Display Space
Display Dims: 168" w x 168" d x 94" h

xpressions[®]SNAP! SHEER

Xpressions[®] SHEER fabric graphics incorporated into exhibit and retail environments is one of the hottest trends hitting the display world. Why not combine this up-and-coming excitement with one of most popular face-to-face marketing tools, Xpressions[®]? Take the most unique fabric pop-up system and combine it with SHEER graphics and the result is a pop-up that makes a strong style statement.

With SHEER, you can create depth and imagery more in-tune with environmental exhibit design and provide your designers with additional tools to drive your brand. Create a more comfortable setting for face-to-face engagement at your next tradeshow. SHEER pop-ups can be key components in environments by creating backdrops, space definition or vertical elements in your space design. Have an existing Xpressions[®]SNAP![™] display? Add SHEER skins to the front plane of the display and bring a fresh new look to your next trade show or event. Combine with lighting and transform your budget into areas previously thought unattainable.

See through the forest of mediocrity with Xpressions[®]SNAP![™]SHEER.

Sheer 1x3 Kit A

- Frame & Graphics \$736
 - 1 x 2 skin (2) - one sheer, one regular
 - 1 x 1 skin (2) - one sheer, one regular
- 50 watt halogen lights (1) \$59
- Hard shipping case \$144
- Total Price \$939**

Dimensions

Open: 32.25"W x 94"H x 12.75"D
 Closed: 3.5"W x 7"L x 33.75"H

Kit Weight

21 lbs.

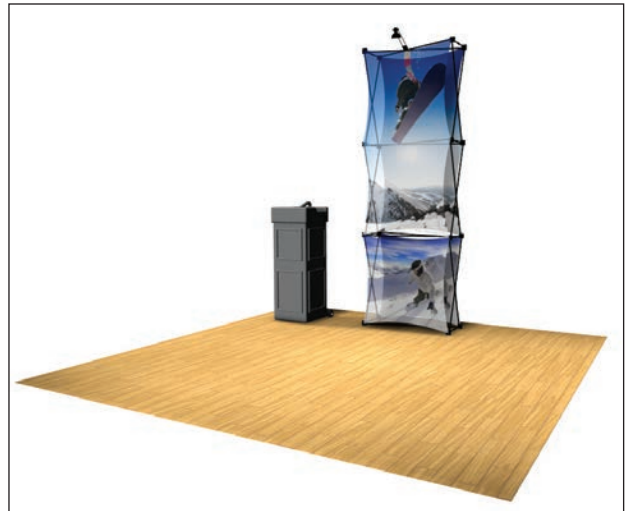

Sheer 1x3 Kit B

- Frame & Graphics \$765
 - 1 x 1 skin (6) - three sheer, three regular
- 50 watt halogen lights (1) \$59
- Hard shipping case \$144
- Total Price \$968**

Dimensions

Open: 32.25"W x 94"H x 12.75"D
 Closed: 3.5"W x 7"L x 33.75"H

Kit Weight

21 lbs.



xpressions[®] SNAP! SHEER

Xpressions[®] SHEER fabric graphics incorporated into exhibit and retail environments is one of the hottest trends hitting the display world. Why not combine this up-and-coming excitement with one of most popular face-to-face marketing tools, Xpressions[®]? Take the most unique fabric pop-up system and combine it with SHEER graphics and the result is an ultra-sheik pop-up that makes a strong style statement.

With SHEER, you can create depth and imagery more in-tune with environmental exhibit design and provide your designers with additional tools to drive your brand. Create a more comfortable setting for face-to-face engagement at your next tradeshow. SHEER pop-ups can be key components in environments by creating backdrops, space definition or vertical elements in your space design. Have an existing Xpressions[®]SNAP![™] display? Add SHEER skins to the front plane of the display and bring a fresh new look to your next trade show or event. Combine with lighting and transform your budget into areas previously thought unattainable.

See through the forest of mediocrity with Xpressions[®]SNAP![™]SHEER.

Sheer 3x3 Kit A

- Frame & Graphics \$1,991
 - 1 x 2 skin (4) - two sheer, two regular
 - 1 x 1 skin (5) - three sheer, two regular
 - 1 x 3 skin (1) - regular
- 50 watt halogen lights (2) \$118
- Hard shipping case \$144
- Total Price \$2,253**

Dimensions

Open: 93.5"W x 94"H x 12.75"D
Closed: 7"W x 7"L x 33.75"H

Kit Weight

32 lbs.



Sheer 3x3 Kit B

- Frame & Graphics \$2,049
 - 1 x 1 skin (13) - seven sheer, six regular
 - 1 x 3 skin (1) - regular
- 50 watt halogen lights (2) \$118
- Hard shipping case \$144
- Total Price \$2,311**

Dimensions

Open: 93.5"W x 94"H x 12.75"D
Closed: 7"W x 7"L x 33.75"H

Kit Weight

32 lbs.



xpressions[®]SNAP![™] SHEER

Xpressions[®] SHEER fabric graphics incorporated into exhibit and retail environments is one of the hottest trends hitting the display world. Why not combine this up-and-coming excitement with one of most popular face-to-face marketing tools, Xpressions[®]? Take the most unique fabric pop-up system and combine it with SHEER graphics and the result is an ultra-sheik pop-up that makes a strong style statement.

With SHEER, you can create depth and imagery more in-tune with environmental exhibit design and provide your designers with additional tools to drive your brand. Create a more comfortable setting for face-to-face engagement at your next tradeshow. SHEER pop-ups can be key components in environments by creating backdrops, space definition or vertical elements in your space design. Have an existing Xpressions[®]SNAP![™] display? Add SHEER skins to the front plane of the display and bring a fresh new look to your next trade show or event. Combine with lighting and transform your budget into areas previously thought unattainable.

See through the forest of mediocrity with Xpressions[®]SNAP![™]SHEER.

Sheer 4x3US Kit A

- Frame & Graphics \$2,511
 - Diamond skin (1) - sheer
 - 1 x 2 skin (6) - two sheer, four regular
 - 1 x 1 skin (6) - two sheer, four regular
- 50 watt halogen lights (2) \$118
- Hard shipping case \$144
- Total Price \$2,773**

Dimensions

Open: 117.5"W x 89.5"H x 13"D
Closed: 10"W x 9"L x 32.5"H

Kit Weight

42 lbs.



Sheer 4x3US Kit B

- Frame & Graphics \$2,965
 - 1 x 1 skin (24) - twelve sheer, twelve regular
- 50 watt halogen lights (2) \$118
- Hard shipping case \$144
- Total Price \$3,227**

Dimensions

Open: 117.5"W x 89.5"H x 13"D
Closed: 10"W x 9"L x 32.5"H

Kit Weight

42 lbs.



xpressions
SALESMATE™
The Perfect Table Top Display... Anywhere You're Short On Time & Space!

2 x 2 Display

SALESMATE™ is a great support tool that can be used to showcase two or more important product facts while promoting product and company brand awareness. It sets up in five seconds or less and collapses even faster! Easy graphic change out makes customized visits a snap. Far superior to other forms of display - it fits in your sample case or carry on luggage. It is compact and hasselfree.

If you choose recycled graphics option graphics are composed of 88% recycled material made from soda bottles. With these options SALESMATE™ has a far lower carbon footprint than the typical bulky pop-ups.

Each Configuration includes black carry bag.

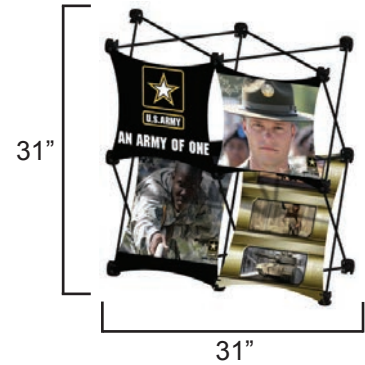

2x2 Salesmate™ (D) w/carry bag Regular Fabric \$401

2x2 Salesmate™ Kits & carry bag

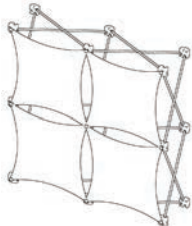

Configuration A with carry bag
Regular Fabric \$401
Recycled Fabric \$418

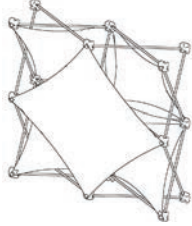

Configuration B with carry bag
Regular Fabric \$483
Recycled Fabric \$508



Configuration C with carry bag
Regular Fabric \$399
Recycled Fabric \$416

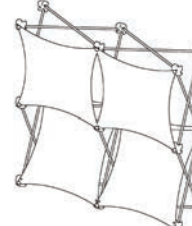

Configuration D with carry bag
Regular Fabric \$401
Recycled Fabric \$418

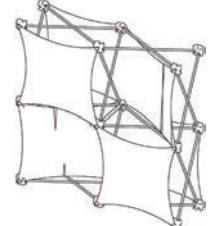

Configuration E with carry bag
Regular Fabric \$481
Recycled Fabric \$506

Multiple graphic pricing per skin:
(For multiple recycled graphic pricing add 10% to prices below.)

Graphic Qty.	1x1 Graphic	1x2 Graphic	2x2 Graphic	Diamond Graphic
1	\$42	\$82	\$164	\$82
2 - 10	\$39	\$78	\$156	\$78
11 - 25	\$35	\$70	\$140	\$70
26 - 50	\$30	\$60	\$120	\$60
51 - 100	\$24	\$48	\$96	\$48
100 +	\$17	\$34	\$68	\$34

2x2 Salesmate™ Frame Pricing
(does not include carry bag.)

Frame Qty.	Price
1 - 10	\$200 each
11 - 25	\$195 each
26 - 50	\$190 each
51 - 100	\$185 each

2x2 Frame Only
Price..... \$200.00
(Frame is not available without graphic)

Replacement Black Carry Bag
Price..... \$28



Shelf
Type: Rectangular (1/8" sintra)
Color: Black
Dimension: 14" x 7.3135" x 1/2"
Holds 5lbs. or less
Price..... \$15

Weight
Unit only.... .95 lbs.
Unit & Graphic.... 3.15 lbs.
(For shipping weight add 2-5lbs for box and packaging)

- See Xpressions® Salesmate™ A La Carte Graphic Wholesale Pricing on Page PF - 23

xpressions[®]
SALESMATE™
The Perfect Table Top Display... Anywhere You're Short On Time & Space!

3 Quad Pyramid

SALESMATE™ is a great support tool that can be used to showcase two or more important product facts while promoting product and company brand awareness. It sets up in five seconds or less and collapses even faster! Easy graphic change out makes customized visits a snap. Far superior to other forms of display - it fits in your sample case or carry on luggage. It is compact and hassle free.

If you choose recycled graphics option graphics are composed of 88% recycled material made from soda bottles. With these options SALESMATE™ has a far lower carbon footprint than the typical bulky pop-ups.

Each Configuration includes black carry bag.

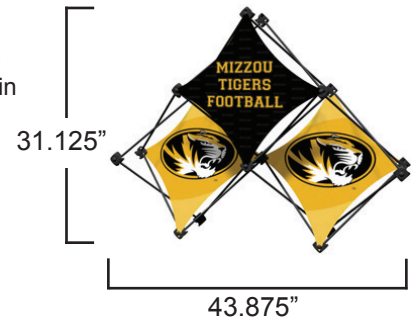

3 Quad Pyramid Salesmate™ (D)
 w/carry bag Regular Fabric \$319

3 Quad Pyramid Salesmate™ Kits & carry bag



Configuration A
 with carry bag
 Regular Fabric \$319
 Recycled Fabric \$332



Configuration B
 with carry bag
 Regular Fabric \$319
 Recycled Fabric \$332



Configuration C
 with carry bag
 Regular Fabric \$401
 Recycled Fabric \$422



Configuration D
 with carry bag
 Regular Fabric \$319
 Recycled Fabric \$332



Configuration E
 with carry bag
 Regular Fabric \$319
 Recycled Fabric \$332

Multiple graphic pricing per skin:
 (For multiple recycled graphic pricing add 10% to prices below.)

Graphic Qty.	1x1 Graphic	1x2 Graphic	Diamond Graphic
1	\$42	\$82	\$82
2 - 10	\$39	\$78	\$78
11 - 25	\$35	\$70	\$70
26 - 50	\$30	\$60	\$60
51 - 100	\$24	\$48	\$48
100 +	\$17	\$34	\$34

3 Quad Pyramid Salesmate™ Frame Pricing:
 (does not include carry bag.)

Frame Qty.	Price
1 - 10	\$160 each
11 - 25	\$155 each
26 - 50	\$150 each
51 - 100	\$145 each

3 Quad Pyramid Frame Only

Price..... \$160.00
 (Frame is not available without graphic)

Replacement Black Carry Bag

Price..... \$28



Weight

Unit only.... .95 lbs.
 Unit & Graphic.... 2.65 lbs.
 (For shipping weight add 2-5lbs for box and packaging)

Shelves

Type: Rectangular (1/8" sintra)
 Holds - 5lbs. or less
 Colors: Black, White or UV printed
 Dimension: 14" x 7.3135" x 1/2"
 Weight: .95lbs.

Black & White Price..... \$15
 UV printed Price..... \$25

Type: Oval (1/8" sintra)
 Holds - 3lbs. or less
 Colors: Black, White or UV printed
 Dimension: 15.25" x 8.25" x 1/4"
 Weight: .54lbs.

Black & White Price..... \$15
 UV printed Price..... \$25

Type: Circle (1/8" sintra)
 Holds - 3lbs. or less
 Colors: Black, White or UV printed
 Dimension: 8" x 8" x 1/4"
 Weight: .22lbs.

Black & White Price..... \$15
 UV printed Price..... \$25

- See Xpressions® Salesmate™ A La Carte Graphic Wholesale Pricing on Page PF - 23

xpressions[®]
SALESMATE™ 2 x 2
EXHIBITOR SERIES



Shown on 6ft. table

SalesMate™ is one of the hottest new display options on the market. Compact, convenient and easy set-up, The SalesMate™ is small in size when traveling, upon set-up the all inclusive skins provide great impact! The SalesMate™ Exhibitor Series Kits were designed to provide turn-key table top display options that carry over the excitement and purpose of xpressions®.

The Exhibitor Series Kits include everything needed to travel and display efficiently at trade shows. Set-up is a breeze with a full size 8' throw emblazoned with a large perma logo presence. Each 8' throw can be converted to a 6' with the included velcro tabs. The SalesMate™ display comes with the graphics already on the frame.

Traveling with large displays is not always possible, choosing SalesMate™ compromises nothing except the hassle! SalesMate™ Exhibitor Series table top kits eliminate a little stress out of life. Have a great show!

Kit A:

- 2x2 SalesMate™ frame & graphic..... \$396
- 6-8ft. Convert-a-Throw, one color permalogo..... \$135
- Large Soft Carry Bag..... \$35
- Total Price..... \$566**

Shipping Weight..... 9lbs.
 (Includes frame, graphic, carry bag and Convert-a-throw in box with packaging.)

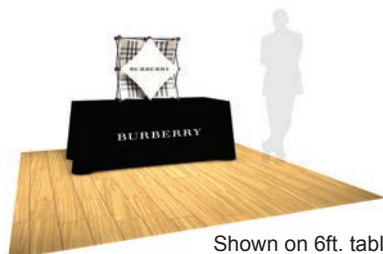
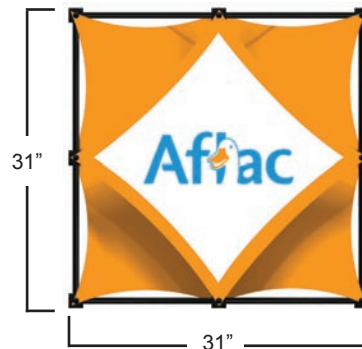

Shown on 6ft. table

Kit B:

- 2x2 SalesMate™ frame & graphic..... \$478
- 6-8ft. Convert-a-Throw, one color permalogo..... \$135
- Large Soft Carry Bag..... \$35
- Total Price..... \$648**



Shown on 6ft. table

Kit C:

- 2x2 SalesMate™ frame & graphic..... \$396
- 6-8ft. Convert-a-Throw, one color permalogo..... \$135
- Large Soft Carry Bag..... \$35
- Total Price..... \$566**



Shown on 6ft. table

Kit D:

- 2x2 SalesMate™ frame & graphic..... \$396
- 6-8ft. Convert-a-Throw, one color permalogo..... \$135
- Large Soft Carry Bag..... \$35
- Total Price..... \$566**



Shown on 6ft. table

Kit E:

- 2x2 SalesMate™ frame & graphic..... \$476
- 6-8ft. Convert-a-Throw, one color permalogo..... \$135
- Large Soft Carry Bag..... \$35
- Total Price..... \$646**



Large Soft Carry Bag

NOTE FOR TABLE THROW LOGOS/ART:

If your logo/art is over 13" h add \$15 to the total price.

If you use more than one color in your logo/art add \$50 per additional color to the total price.

xpressions[®]
SALESMATE™
EXHIBITOR SERIES

3 Quad



Shown on 6ft. table

SalesMate™ is one of the hottest new display options on the market. Compact, convenient and easy set-up, The SalesMate™ is small in size when traveling, upon set-up the all inclusive skins provide great impact! The SalesMate™ Exhibitor Series Kits were designed to provide turn-key table top display options that carry over the excitement and purpose of xpressions®.

The Exhibitor Series Kits include everything needed to travel and display efficiently at trade shows. Set-up is a breeze with a full size 8' throw emblazoned with a large perma logo presence. Each 8' throw can be converted to a 6' with the included velcro tabs. The SalesMate™ display comes with the graphics already on the frame.

Traveling with large displays is not always possible, choosing SalesMate™ compromises nothing except the hassle! SalesMate™ Exhibitor Series table top kits eliminate a little stress out of life. Have a great show!

Kit A:

- 3Quad SalesMate™ frame & graphic..... \$314
- 6-8ft. Convert-a-Throw, one color permalogo..... \$135
- Large Soft Carry Bag..... \$35
- Total Price..... \$484**

- Shipping Weight..... 8lbs.
- (Includes frame, graphic, carry bag and Convert-a-throw in box with packaging.)



Shown on 6ft. table

Kit B:

- 3Quad SalesMate™ frame & graphic..... \$314
- 6-8ft. Convert-a-Throw, one color permalogo..... \$135
- Large Soft Carry Bag..... \$35
- Total Price..... \$484**



Shown on 6ft. table

Kit C:

- 3Quad SalesMate™ frame & graphic..... \$396
- 6-8ft. Convert-a-Throw, one color permalogo..... \$135
- Large Soft Carry Bag..... \$35
- Total Price..... \$566**

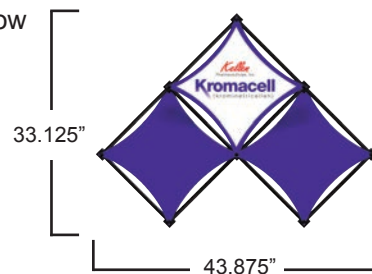

Shown on 6ft. table

Kit D:

- 3Quad SalesMate™ frame & graphic..... \$314
- 6-8ft. Convert-a-Throw, one color permalogo..... \$135
- Large Soft Carry Bag..... \$35
- Total Price..... \$484**



Shown on 6ft. table

Kit E:

- 3Quad SalesMate™ frame & graphic..... \$314
- 6-8ft. Convert-a-Throw, one color permalogo..... \$135
- Large Soft Carry Bag..... \$35
- Total Price..... \$484**



Large Soft Carry Bag

NOTE FOR TABLE THROW LOGOS/ART:

If your logo/art is over 13" h add \$15 to the total price.

If you use more than one color in your logo/art add \$50 per additional color to the total price.

xpressions[®]
SALES MATE™ 4 x 3
EXHIBITOR SERIES



SalesMate™ is one of the hottest new display options on the market. Compact, convenient and easy set-up, The SalesMate™ is small in size when traveling, upon set-up the all inclusive skins provide great impact! The SalesMate™ Exhibitor Series Kits were designed to provide turn-key table top display options that carry over the excitement and purpose of xpressions®.

The Exhibitor Series Kits include everything needed to travel and display efficiently at trade shows. Set-up is a breeze with a full size 8' throw emblazoned with a large perma logo presence. Each 8' throw can be converted to a 6' with the included velcro tabs. The SalesMate™ display comes with the graphics already on the frame.

Traveling with large displays is not always possible, choosing SalesMate™ compromises nothing except the hassle! SalesMate™ Exhibitor Series table top kits eliminate a little stress out of life. Have a great show!

Kit A:

- 4 x 3 SalesMate™ frame & graphic..... \$1,588
- 8ft. Convert-a-Throw, one color permalogo..... \$135
- Large Soft Carry Bag..... \$35
- Total Price..... \$1,758**



Shipping Weight..... 15lbs.
 (Includes frame, graphic, carry bag and Convert-a-throw in box with packaging.)



Large Soft Carry Bag

Kit B:

- 4 x 3 SalesMate™ frame & graphic..... \$1,252
- 8ft. Convert-a-Throw, one color permalogo..... \$135
- Large Soft Carry Bag..... \$35
- Total Price..... \$1,422**



Kit D:

- 4 x 3 SalesMate™ frame & graphic..... \$1,500
- 8ft. Convert-a-Throw, one color permalogo..... \$135
- Large Soft Carry Bag..... \$35
- Total Price..... \$1,670**

Kit

- 4 x 3 SalesMate™ frame & graphic..... \$1,246
- 8ft. Convert-a-Throw, one color permalogo..... \$135
- Large Soft Carry Bag..... \$35
- Total Price..... \$1,416**

NOTE FOR TABLE THROW LOGOS/ART:

If your logo/art is over 13" h add \$15 to the total price.

If you use more than one color in your logo/art add \$50 per additional color to the total price.



A La Carte Graphic Wholesale Pricing

Quads / Description / Pricing			Skin Size	
1x1	Flat	\$42	13.375"w	x 13.375"h
1x1	Single Twist	\$42	14.25"w	x 14.25"h
1x1	Double Twist	\$42	14.75"w	x 14.75"h
1x1	Thread (h)	\$42	15"w	x 13.375"h
1x1	Thread (v)	\$42	13.375"w	x 15"h
1x2				
1x2	Flat	\$82	13.375"w	x 26.25"h
1x2	Thread	\$82	13.375"w	x 28"h
1x2	Double Thread	\$82	13.375"w	x 29"h
1x2	Single Twist	\$82	13.375"w	x 26.75"h
1x2	Double Twist	\$82	13.375"w	x 27"h
1x3				
1x3	Flat	\$126	13.375"w	x 39.5"h
1x3	Double Thread	\$126	13.375"w	x 43.375"h
1x3	Single thread	\$126	13.375"w	x 41.375"h
2x1				
2x1	Flat	\$82	26.25"w	x 13.375"h
2x1	Thread	\$82	28"w	x 13.375"h
2x1	Double Thread	\$82	29"w	x 13.375"h
2x1	Single Twist	\$82	26.75"w	x 13.375"h
2x1	Double Twist	\$82	27"w	x 13.375"h
4x1				
4x1	Flat	\$164	52.25"w	x 13.375"h
4x3				
4x3	Flat	\$445	52.25"w	x 41"h
Diamond				
		\$82	19.75"w	x 19.75"h
2x2				
2x2	Flat	\$168	27"w	x 27"h
3x3				
3x3	Flat	\$378	41"w	x 41"h
Hex*				
		\$252	26.25"w	x 41"h
Star				
		\$42	13.375"w	x 13.375"h
Triangle				
		\$28	13.375"w	x 13.375"h

Frame Only Pricing	
Frame Size	Price
2x2	\$200
3 Quad Pyramid	\$160
4x3	\$664

*Hex Skin Size

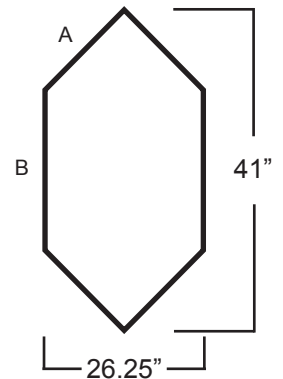

A = 18.87"
B = 13.375"

Duplicate Discounts	
Quantity	Discount Factor (frame & graphic skins)
1	1.0
2-5	.97
6-10	.96
11-15	.95
16-25	.94
Above 50	Please Request Quote
Graphic Kits	
Deduct 10% from the sum of the cost of the graphics in that kit.	

Salesmate 1x1 Led Lightbox:

Price \$192 each

Optional Backlit 1x1 Xpressions®SNAP!™ skin:

Price \$47 each

xpressions® PUSHTHRU™

Xpressions@PUSHTHRU™ will complete your display - Hassel Free!

Use Xpressions@PUSHTHRU™ to create 90° of message to your display, to assist as directional and welcome solutions or to add accent to your marketing design.

Continue your marketing message by choosing from many different PUSHTHRU skin designs and have a different PUSHTHRU skin up each day of the show.

Give your Xpressions@SNAP™ display an HD feel with theXpressions@PUSHTHRU™.



10' x 20' Xpressions Display with two 1x3 Thin PushThru skins



10' x 20' Xpressions Display with two 1x3 Triangle PushThru skins



10' x 10' Xpressions Display with two 1x3 Wide PushThru skins

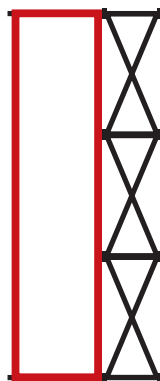

1x3 Thin skin w/hardware \$316 ea



1x3 Wide skin w/hardware \$404 ea

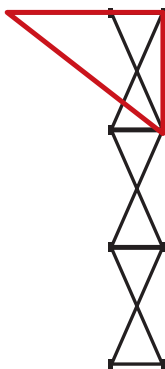

1x1 Triangle skin w/hardware \$125 ea

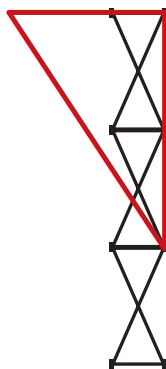

1x2 Triangle skin w/hardware \$186 ea

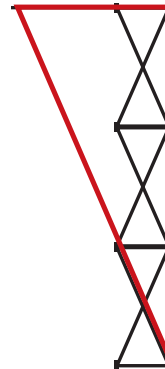

1x3 Triangle skin w/hardware \$247 ea



Kit A -

- Regular Fabric: \$1,369.00
- Recycled Fabric: \$1,434.00
- Case / Case-to-counter top and rollable tambour
- Fabric graphic counter wrap
- Xpressions Snap 3 Quad (A) Table Top w/printed backer
- Unprinted 8' Full Table Throw / 30"x66" dye sub select runner (unless table throw needs to be cored or bolted)

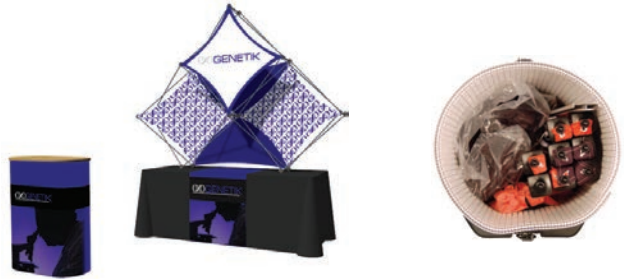

Kit B -

- Regular Fabric: \$2,600.00
- Recycled Fabric: \$2,742.00
- Case / Case-to-counter top and rollable tambour
- Fabric graphic counter wrap
- Xpressions Snap 4x3 US (B)



Kit C -

- Regular Fabric: \$1,717.00
- Recycled Fabric: \$1,782.00
- Case / Case-to-counter top and rollable tambour
- Fabric graphic counter wrap
- Xpressions Snap 2x2 (A)
- Unprinted 8' Full Table Throw / 30"x66" dye sub select runner (unless table throw needs to be cored or bolted)
- 2 lights in bag



View of contents under light bag.

Kit D -

- Regular Fabric: \$1,928.00
- Recycled Fabric: \$2,020.00
- Case / Case-to-counter top and rollable tambour
- Fabric graphic counter wrap
- Xpressions Snap 3x3 (H)



NOTE: Other Xpressions®Snap™ configurations are available for kits shown above. Contact your customer service representative for pricing and details.

xpressions[®] CONNEX[™]

1x3 LED Lightboxes

Xpressions@CONNEX™ transforms the Xpressions@SNAP™ pop-up into an exciting modular display system perfect for trade show or event environments. The key to unlocking your creativity is a simple innovation to the Xpressions@SNAP™ frame: a simple clip on the hub and the addition of a trapezoid and square connecting shelf along with the original rectangular shelf.

Connecting the frames at different angles or in straight lines adds yet another dimension to the Xpressions® exhibit. Dynamic connecting skins are used in combination with square, trapezoid or rectangular connecting shelves to create dramatic inline spaces, concave and convex configurations. Even create octagon islands for events. Add LED lightboxes to highlight your message!

Xpressions CONNEX Power Play 1 LED Lightbox

- Four 1x3 Xpressions@SNAP!™ frames & graphics..... \$2,340
- Two Rectangular CONNEX shelves..... \$84
- One Rectangular shelves..... \$168
- Two Trapezoid shelves..... \$88
- Hourglass Thread skins..... \$251 (c)
- Three Lights..... \$177
- One 1x3 LED lightbox & graphic..... \$1,031 (c)

Wholesale Total \$4,013

With optional Premium Backlit skins - Wholesale Total \$4,038

(c) Connector Skin

Shipping Cases

Fits in 2 Xpressions Shipping Cases. Add for \$288

Wholesale Total w/Cases \$4,301

Display Dimensions: 123"w x 47.5"d x 94"h

Shipping Weight: 43.5lbs. Add 2-5lbs for box & packing

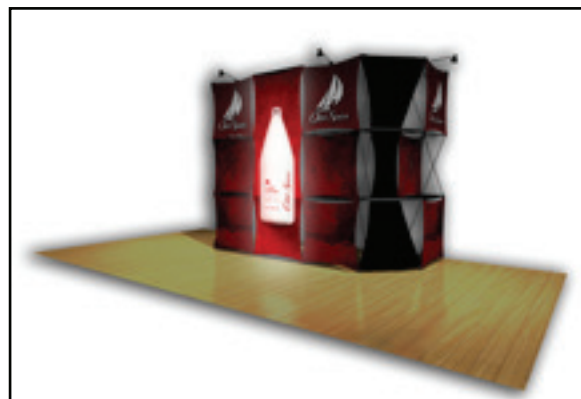

Xpressions CONNEX Power Play 2 LED Lightbox

- Four 1x3 Xpressions@SNAP!™ frames & graphics..... \$2,340
- Four Rectangular CONNEX shelves..... \$168
- Four Rectangular shelves..... \$168
- Two Lights..... \$118
- Two 1x3 LED lightboxes & graphics..... \$2,062 (c)

Wholesale Total \$4,856

With optional Premium Backlit skins - Wholesale Total \$4,906

(c) Connector Skin

Shipping Cases

Fits in 2 Xpressions Shipping Cases. Add for \$288

Wholesale Total w/Cases \$5,194

Display Dimensions: 190"w x 13"d x 94"h

Shipping Weight: 43.5lbs. Add 2-5lbs for box & packing



Xpressions CONNEX Power Play 3 LED Lightbox

- Four 1x3 Xpressions@SNAP!™ frames & graphics..... \$2,340
- Six Rectangular CONNEX shelves..... \$252
- Four Rectangular shelves..... \$168
- Four Lights..... \$236
- Three 1x3 LED lightboxes & graphics..... \$3,093 (c)

Wholesale Total \$6,089

With optional Premium Backlit skins - Wholesale Total \$6,164

(c) Connector Skin

Shipping Cases

Fits in 2 Xpressions Shipping Cases. Add for \$288

Wholesale Total w/Cases \$6,377

Display Dimensions: 218"w x 13"d x 94"h

Shipping Weight: 43.5lbs. Add 2-5lbs for box & packing

xpressions® QTR/20

The Xpressions QTR/20 frame is unique. Each hub is out fitted with QTR/20 thread that allows the frame to accept accessories and increases the structural integrity of the frame.

Xpressions QTR/20 A

- 3x3 xpressions QTR/20 frame
- w/Push Thrus \$1295
- 1 - 3x3 Back skin with end caps \$672
- 8 - Triangle skins \$536
- 1 - 1x1 Flat skin \$98
- Kit Total \$2,600**

Kit fits in 1 hard shipping case
Xpressions QTR/20 require a 5 day lead time.

Open Frame Dimensions = 93.5"w x 94"h x 12.75"d
Closed Frame Dimensions = 7"w x 7"L x 33.75"h

Kit Shipping Weight = 28lbs.



Xpressions QTR/20 B

- 3x3 xpressions QTR/20 frame
- w/Push Thrus \$1295
- 1 - 3x3 Back skin with end caps \$672
- 4 - Triangle skins \$268
- Kit Total \$2,235**

Kit fits in 1 hard shipping case
Xpressions QTR/20 require a 5 day lead time.

Open Frame Dimensions = 93.5"w x 94"h x 12.75"d
Closed Frame Dimensions = 7"w x 7"L x 33.75"h

Kit Shipping Weight = 28lbs.



Xpressions QTR/20 C

- 3x3 xpressions QTR/20 frame
- w/Push Thrus \$1295
- 1 - 3x3 Back skin \$588
- 1 - 3x3 Sheer skin \$588
- 2 - 1x1 Flat skins \$196
- Kit Total \$2,667**

Kit fits in 1 hard shipping case
Xpressions QTR/20 require a 5 day lead time.

Open Frame Dimensions = 93.5"w x 94"h x 12.75"d
Closed Frame Dimensions = 7"w x 7"L x 33.75"h

Kit Shipping Weight = 28lbs.

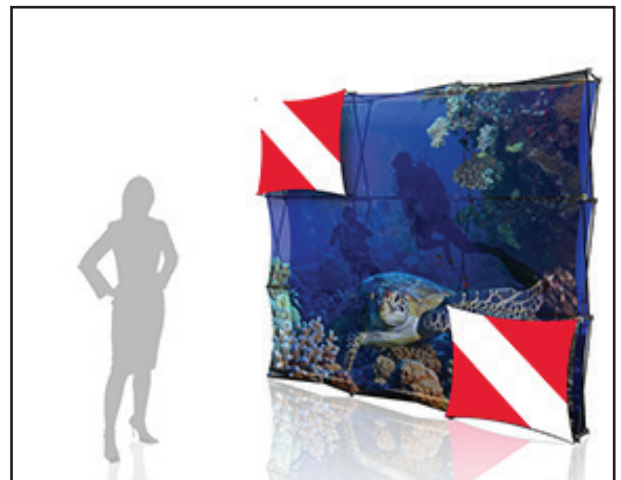

xpressions® QTR/20

The Xpressions QTR/20 frame is unique. Each hub is out fitted with QTR/20 thread that allows the frame to accept accessories and increases the structural integrity of the frame.

Xpressions QTR/20 D

4x3 xpressions QTR/20 frame w/Push Thrus	\$1,677
1 - 4x3 Back skin with end caps	\$875
1 - 4x1 Sheer skins	\$334
1 - 2x1 Flat skin	\$180
Kit Total	\$3,066

Xpressions QTR/20 require a 5 day lead time.
Kit fits in 1 hard shipping case

Open Frame Dimensions = 117.5"w x 94"h x 12.75"d
Closed Frame Dimensions = 10"w x 9"L x 32.5"h

Kit Shipping Weight = 34lbs.



Xpressions QTR/20 E

4x3 xpressions QTR/20 frame w/Push Thrus & 4x1 custom frame to attach to 4x3 frame	\$1,966
1 - 30"x30" UV Direct Print Sintra Header	\$50
2 - Header Brackets	\$187
4 - Shelves	\$600
1 - 4x3 Back skin with end caps	\$875
1 - 4x1 Skin	\$334
1 - 3x1 Sheer skin	\$251
Kit Total	\$4,263

Xpressions QTR/20 require a 5 day lead time.
Kit fits in 2 hard shipping case

Kit Shipping Weight = 56lbs.



xpressions® QTR/20

Accessories



Canvas Bag
Black canvas w/ handles;
Weight: 3.2 lbs. (w/o graphic)
Dim: 35" w x 10" d x 9" h
Price.....\$48 ea.



Hard Case w/ Wheels
Holds up to 20' of display,
Ex. one 3x3, two 2x3 and one 2x2;
Weight: 12.8 lbs. (w/o graphic)
Dim: outside - 14" w x 14" d x 41" h
inside - 13" w x 13" d x 35" h
Price.....\$144 ea.

Wire Management Clip
Small black cable clip to attach to
Xsnap™ frame and hold light wires.
Color: Black
Price.....\$5 / box of 12

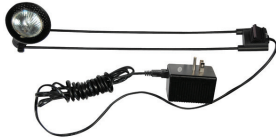

50 watt halogen light
w/attachment clip;
Colors: black or silver
Price.....\$59 ea.



LED Pop-up Light;
available in black\$88 ea.



Light Bag
Black canvas w/ handles;
holds 2 lights
Price.....\$30 ea.

Xpressions® 223 Counter & Workstation

Counter Frame & Top
w/ dyesub printed counter &
monitor stand wrap:
Price \$647

20.5"

72"

Counter Frame & Top
w/ dyesub wrap:
Price \$470

36"



The most flexible, modular portable exhibition system. An exhibition stand that is different! Twist offers incredible flexibility, stability and ease of use. The Twist has been designed to fulfill a wide range of exhibiting solutions, from 10' spaces to endless backwalls.

The Twist gives you the ultimate in flexibility and value for your money. no tools necessary for kit assembly.



Pricing

Twist Display Kit Total Price \$2,156

Includes:

- 8ft Twist Display with Hardware
- Two 86.625" x 39.4" Lambda Bright flat graphic panels w/ hardware
- One 86.625" x 21.7" Lambda Bright Flexi Connector graphic panel w/hardware
- Two lights
- Small single hard shipping case

Connect 8ft Twist Display Kits by adding a Lambda Bright Flexi Connector graphic panel with connector magnet bar sets. Price \$400 each.

Single hard case Lambda Graphic wrap **\$199**

Double hard case Lambda Graphic wrap ... **\$236**



Case open Case closed w/Graphic Wrap

Two 8ft Twist kits w/Lambda Bright, 1 Flexi Connector panel & 2 single cases w/graphic \$5,232

Replacement Graphics & Hardware

86.625" x 39.4" Lambda Bright flat graphic panels w/hardware \$385 each

86.625" x 21.7" Lambda Bright Flexi Connector graphic panel w/hardware \$345 each



Create backdrops and exhibition displays that are unique. Center connection panel bends to create convex to concave displays.



Add a monitor to your Twist Kit for multi media activity.
(Price of kit shown \$2,660 - monitor not included in price.)



Four Twist Kits and Three Flexi Connector panels fill up a 10' x 20' display space.
(Price of kit shown \$10,702)



Two Twist Kits and one additional Flexi Connector panel combine to form a corner display.
(Price of kit shown \$5,070)

● Specifications

Shipping Weight
51 lbs.

Foot Color
Black

● Accessories

Shipping Cases

When ordering multiple kits you can combine cases or use multiple single case options.

Price \$195 each

(Graphics available for single and two case options.)

Media Bracket & Base (optional)

Price \$305 each

Single Case Hard top (optional)

Price \$61 each

Double Case Hard top (optional)

Price \$122 each



Single Hard Case
Size: 43”h x 16”w x 12”d



Two Hard Cases
Size: 43”h x 16”w x 16”d

expand[®] Linkwall

This highly flexible and reusable wall is a perfect investment to be used for different occasions and locations. The Expand LinkWall is a display system with a magnetic solution and a built-in flexibility that enables the user to change the shape of the product.

The user can easily make it smaller or larger depending on space and bend it to different shapes to fit the event space. Change the size of the mural by simply adding or removing panels to better fit your environment. It can be used as a straight wall on one occasion, and thanks to the flexible panels, an S-Shape, L-Shape or Serpentine on other occasions.

● Pricing

Linkwall 3 Panel Kit Total Price \$2,525

Includes:

- 8ft Expand Linkwall Display with Hardware
- Two 86.62" x 35.3" Lambda Bright Flat graphic panels w/hardware
- One 86.62" x 23.62" Lambda Bright Connector graphic panel w/hardware
- Two LED lights
- Hard shipping case*

Linkwall 5 Panel Kit Total Price \$3,653

Includes:

- 8ft Expand Linkwall Display with Hardware
- Three 86.62" x 35.3" Lambda Bright Flat graphic panels w/hardware
- Two 86.62" x 23.62" Lambda Bright Connector graphic panel w/hardware
- Three LED lights
- Hard shipping case*

Replacement Graphics & Hardware

86.62" x 35.43" Lambda Bright Flat graphic w/hardware \$324 each

86.62" x 23.62" Lambda Bright Connector graphic w/hardware \$228 each

● Specifications

Shipping Weight

Linkwall 3 Panel Kit60 lbs.

Linkwall 3 Panel Kit70 lbs

Foot Color

Silver



Expand Linkwall 8' Flex Wall w/ Lambda Bright graphics & case to counter conversation \$3,172



* Make your Hard Shipping Case (included in Linkwall kit) a Case to Counter Conversion with graphic Price **\$647**



Expand Linkwall U-Shape w/end caps, 3 cases (1 case to counter conversion) with graphics & 7 lights (Price of kit shown \$10,881)

Expand Linkwall Triangle Tower with graphics & Case (Price of kit shown \$3,175)



eco-1st BAMBOO™ Retractable

Eco-1st Bamboo retractable banner stand is as beautiful as it is eco friendly. Created from sustainable bamboo resources and outfitted with MircoKnit recycled graphics, Bamboo retractable is the ultimate convergence in style, quality and global responsibility.

MicroKnit recycled graphics use the water based Kaleidoscope Select process to produce crisp brightly colored images. Sharp flat recycled fabric graphics and gorgeously finished natural bamboo hardware project this retractable into a class of it's own. Whether you are meeting your organizations green initiatives, exercising your own awareness or simply looking for a great looking retractable stand, the Bamboo is a great choice!



Bamboo Retractable
31.5" w x 85.5" h
w/Kaleidoscope Select \$360

Pricing (includes graphic, unit and carry bag)

Unit Size	Live Area	Graphic Print Size	Final Size	Bamboo Retractable w/Kaleidoscope Select Recycled MicroKnit
32.5" w	31.5" w x 78.75" h	31.5" w x 85.5" h	31.5" w x 85.5" h	\$360

Unit not available without graphic.

Replacement Graphic - With free installation, deduct the following from the above package prices:
32.5" Unit\$165

Discounts for Duplicate Images Only

The price of the hardware unit is passed on to you at Optima's cost plus shipping and handling and is not discountable. The graphics are discounted based on duplicate volume. To determine the discount for the multiple units, multiply the price for a quantity of one (above) by the following factors:

Quantity	Discount Factor
2-5	.97
6-10	.96
11-15	.95
16-25	.94
26-50	.93
Above 50	Call for quote

Specifications

Unit

- Open: 32.5" w x 81.5" h x 8" d
- Collapsed: 8" d x 3.5" h x 32.5" w
- Material: Bamboo
- Finish: Natural Wood
- Carry Bag: Green cotton - included with graphic & unit pricing

Shipping Weight

Unit with Graphic 12.25 lbs.
(add 2 - 5 lbs. for box and packing)

Shipping Box

Size: 10" x 10" x 36"



Green Cotton carry bag included



Back side view

Grand Stand™

Grand Stand is one of the largest retractable banner stands on the market. The Grand Stand comes in two standard widths and allows for substantial height adjustments. The Grand stand unit is self contained in an aluminum case. The aluminum casing has shoulder straps slots for easier carrying. The Grand stand sets up in seconds. It has two rotating feet for stability and the telescoping pole is equipped with a twist-lock so the height of the graphic can be varied. Units are available in black only.



**Grand Stand 48" w x 64" h
w/Kaleidoscope Select \$676**

Pricing (includes graphic and unit)

Unit Sizes Available	Live Area	Actual Graphic Print Sizes	Lambda Bright	Grand Stand w/Kaleidoscope Select	Mesa
54.5" w	48" w x 39.5" h	48" w x 43.5" h	\$722	\$623	\$631
54.5" w	48" w x 46" h	48" w x 50" h	\$755	\$650	\$659
54.5" w	48" w x 60" h	48" w x 64" h	\$801	\$676	\$688
70.5" w (XL)	64" w x 57.5" h	64" w x 61.5" h	NA	\$830	NA
70.5" w (XL)	64" w x 84" h	64" w x 88" h	NA	\$936	NA
70.5" w (XL)	64" w x 107" h	64" w x 111" h	NA	\$1018	NA

• MicroKnit Recycled fabric: Kaleidoscope Select - \$9/sq. ft. - Colossus 4 color - \$9/sq. ft. - Colossus 8 color - \$10/sq. ft

Units may be purchased without graphic

- 54.5" Unit\$495
- 70.5" Unit.....\$595

Specifications

Shipping Weight

54.5" Unit with Graphic 19 lbs.
(add 2 - 5 lbs. for box and packing)

70.5" Unit with Graphic 23 lbs.
(add 2 - 5 lbs. for box and packing)

Shipping Box

54.5" Unit
Size: 6" h x 6" w x 60.5"

70.5" Unit
Size: 6" h x 6" w x 76.5"

Unit Dimensions

54.5" Unit Collapsed:
4.5" h x 5" w x 54.5"

70.5" Unit Collapsed:
4.5" h x 5" w x 70.5"

Unit Color

Black

Accessories

Padded Carrying Bag (Optional)

For the 54.5" w and 70.5" w unit \$155
Price is same for both carry bags



Hard Shipping Cases

54.5" Unit 7.5" x 6" x 64"\$185
70.5" Unit 7.5" x 6" x 80"\$185
Price is same for both cases



M2™

M2 is a flexible and easy-to-use retractable display with an innovative solution that makes it easy to vary between different messages in your display. This retractable display is suited for those who need to change their graphics often, or need to replace a campaign at several locations at the same time. The telescoping pole makes it very easy to adjust the height.

Unique solution for changing your graphics. M2 is a hassle free retractable banner stand. Unlike spring loaded retractables the M2 has a unique patented mechanism that makes set-up and graphic change out super easy. Your marketing becomes more cost-effective since changing your graphic is quick and easy and you can do it yourself!



M2 Padded bag included



Tension System allows you to change your graphics in no time!



**M2 33.25" x 92" h
w/Kaleidoscope Select \$430**

Pricing (includes graphic, unit and carry bag)

Version 2

Unit Sizes Available	Live Area	Actual Graphic Print Sizes	M2 w/Kaleidoscope Select
35" W, 7" deep	33.25"w x 62.5" - 86.625"h	33.25"w x 66.5" - 90.625"h	\$427 (33.25" x 90.625")

Version 1 - If you need to order replacement graphics for the M2 retractable version that was discontinued by the vendor on 8/13/07 please see the specifications below.

How do I know if my unit is a discontinued model? The discontinued units do not have logos on the chrome endcaps.

Unit Sizes Available	Live Area	Actual Graphic Print Sizes	M2 w/Kaleidoscope Select
33.5" W, 7" deep	33.25"w x 64" - 88"h	33.25"w x 68" - 92"h	\$430 (33.25" x 92")

- Microknit Recycled fabric: Kaleidoscope Select - \$9/sq. ft. - Colossus 4 color - \$9/sq. ft. - Colossus 8 color - \$10/sq. ft.

Unit may be purchased without graphic
33.5" Unit w/o graphic.....\$260

Replacement Graphic - (With free installation)
• w/o roller - determine price from fabric price list
• w/ roller - add \$78 to graphic price

Specifications

Shipping Weight (Version 1 & 2)
Unit with Graphic 13.25 lbs.
(add 2 - 5 lbs. for box and packing)

Design and Colors M2 has a minimalist design with a unique look that separates it from the competitors. The unit comes in black with chromed ends.

Graphic Only fabric graphics can be used with the M2. Microknit fabric is recommended.

Accessories

Light 50 watt halogen;
color: chrome w/black top
Price\$115 ea. w/bag

Roll kit (includes roller, hardware and bag; no graphic)
Price \$78



M2 vs. M4

The difference is in the style; **The M2** is only available in black with chrome ends and the base is a clean block with rounded edges. **The MS4** is only available in chrome and the base is a sleek, elegant shape that is tapered slightly forward.

Both units function the same way. They both have the same unique roller design, adjustable mast, highest quality construction, padded case, light option and accept fabric only.

MediaScreen1

The stylish, stable and compact Media Screen 1 features a fully-adjustable mast with measurement tick marks for quick setup and has a larger graphic size of 88". Designed to give a clean appearance, the mast is hidden from view behind the top of the banner. The Media Screen 1 is a single sided unit and the graphic retracts easily into the silver on chrome base. A black padded storage bag is standard with all units.



MediaScreen1 33.25" w x 92" h w/Kaleidoscope Select \$398

Pricing (includes graphic, unit and carry bag)

Unit Sizes Available	Live Area	Actual Graphic Print Sizes	MediaScreen1 w/Lambda Bright	MediaScreen1 w/Kaleidoscope Select	MediaScreen1 w/Mesa	MediaScreen1 w/Diamond Finish	MediaScreen1 Lambda Duraflex & Metallic
33.5" w	33.25" w x 62" h	33.25" w x 66" h	\$446	\$350	\$358	\$367	\$477
33.5" w	33.25" w x 88" h	33.25" w x 92" h	\$525	\$398	\$409	\$421	\$562
39.375" w	39.125" w x 62" h	39.125" w x 66" h	\$505	\$399	\$409	\$419	\$543
39.375" w	39.125" w x 88" h	39.125" w x 92" h	\$597	\$456	\$469	\$482	\$631

• MicroKnit Recycled fabric: Kaleidoscope Select - \$9/sq. ft. - Colossus 4 color - \$9/sq. ft. - Colossus 8 color - \$10/sq. ft.

Units may be purchased without graphic

33.5" Unit\$219
 39.375" Unit\$245

Quantity	Discount Factor
2-5	.97
6-10	.96
11-15	.95
16-25	.94
26-50	.93
Above 50	Call for quote

Discounts for Duplicate Images Only -

The price of the hardware unit is passed on to you at Optima's cost plus shipping and handling and is not discountable. The graphics are discounted based on duplicate volume. To determine the discount for the multiple units, multiply the price for a quantity of one (above) by the following factors:

Specifications

Shipping Weight

33.5" w Unit with Graphic 10.3 lbs.
 (add 2 - 5 lbs. for box and packing)

39.375" w Unit with Graphic 12.3 lbs.
 (add 2 - 5 lbs. for box and packing)

Shipping Box

33.5" w Unit: 10" x 10" x 36"
 39.375" w Unit: 10" x 10" x 48"

Unit Color

Matte Silver on chrome

Accessories

Light

50 watt halogen;
 available in chrome
 w/black top
\$115 ea. w/bag

Shipping Cases

42" h x 5.5" d 50" h x 8" d
\$95\$115



MediaScreen2 (indoor)

The Media Screen 2 (Indoor) is double sided with the same hidden clean mast appearance as the MediaScreen 1 and features updated durable sides. You have the ability to display your message in two directions. The graphics retract into the silver-on-chrome base that features heavy duty durable sides. A black padded storage bag is standard with all units.



**MediaScreen2 39.4" w x 84" h
w/Kaleidoscope Select \$722**

Pricing (includes 2 graphics, unit and carry bag)

Unit Sizes Available	Live Area	Actual Graphic Print Sizes	MediaScreen2 w/Lambda Bright	MediaScreen2 w/Kaleidoscope Select	MediaScreen2 w/Mesa	MediaScreen2 w/Diamond Finish	MediaScreen2 w/Lambda Duraflex & Metallic
33.5" w	33.25" w x 79" h	33.25" w x 84" h	\$822	\$644	\$662	\$684	\$954
39.9" w	39.4" w x 79" h	39.4" w x 84" h	\$990	\$722	\$746	\$770	\$1060

• MicroKnit Recycled fabric: Kaleidoscope Select - \$9/sq. ft. - Colossus 4 color - \$9/sq. ft. - Colossus 8 color - \$10/sq. ft.

Units may be purchased without graphic

- 33.5" Unit\$320
- 39.9" Unit\$340

Discounts for Duplicate Images Only -

The price of the hardware unit is passed on to you at Optima's cost plus shipping and handling and is not discountable. The graphics are discounted based on duplicate volume. To determine the discount % for the multiple units, multiply the price for a quantity of one (above) by the following factors:

Quantity	Discount Factor
2-5	.97
6-10	.96
11-15	.95
16-25	.94
26-50	.93
Above 50	Call for quote

Specifications

Shipping Weight

33.5" w Unit with Graphic 17.10 lbs.
(add 2 - 5 lbs. for box and packing)

39.9" w Unit with Graphic 19.10 lbs.
(add 2 - 5 lbs. for box and packing)

Shipping Box

33.5" w Unit: 10" x 10" x 36"
39.9" w Unit: 10" x 10" x 48"

Unit Color

Matte Silver on chrome

Accessories

Shipping Cases

50" h x 8" d
.....\$115

Light w/adapter*

50 watt halogen;
available in chrome w/black top\$129 ea. w/bag



*Adapter included

MediaScreen 4

MediaScreen 4 is a flexible and easy-to-use retractable display with an innovative solution that makes it easy to vary between different messages in your display. This retractable display is suited for those who need to change their graphics often, or need to replace a campaign at several locations at the same time. The telescoping pole makes it very easy to adjust the height.

Unique solution for changing your graphics. MediaScreen 4 is a hassle free retractable banner stand. Unlike spring loaded retractables the MediaScreen 4 has a unique patented mechanism that makes set-up and graphic change out super easy. No tension exists until the graphic is extended upward, attach to the top of the pole then extend the pole to full height! Thus the MS4 can never lose tension. Available replacement graphic rollers make changing your graphic quick and easy. Best of all, you can do it yourself!

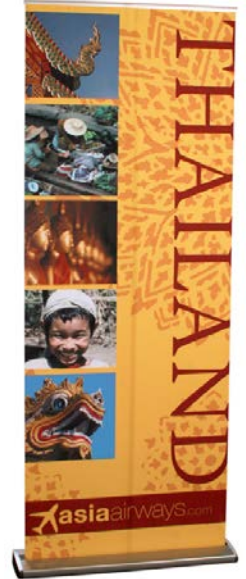

MediaScreen 4 33" w x 88" h w/Kaleidoscope Select \$411

Pricing (includes graphic, unit and carry bag)

Unit Sizes Available	Live Area	Actual Graphic Print Sizes	Media Screen 4 w/Kaleidoscope Select
35.5" W, 8.5" deep	33" w x 62" - 84" h	33" w x 66" - 88" h	\$411 (33" x 88")

- MicroKnit Recycled fabric: Kaleidoscope Select - \$9/sq. ft. - Colossus 4 color - \$9/sq. ft. - Colossus 8 color - \$10/sq. ft.

Unit may be purchased without graphic
33.5" Unit w/o graphic.....\$250

- Replacement Graphic - (With free installation)
- w/o roller - determine price from fabric price list
 - w/ roller - add \$78 to graphic price

Unique roller design allows you to change your graphics safely in no time!

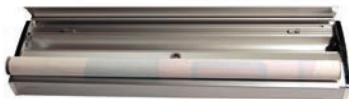

The tension is added as you extend the graphic upward. Tension is then minimized as the graphic is lowered.

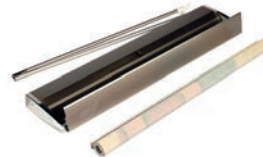

Telescopic Pole
Pole is adjustable at top from 62" to 84" live area height.



Specifications

Shipping Weight (Version 1 & 2)
Unit with Graphic 13.15 lbs.
(add 2 - 5 lbs. for box and packing)

Design and Colors M4 has a minimalist design with a unique look that separates it from the competitors. The unit comes in black with chromed ends.

Graphic Only fabric graphics can be used with the M2. Microknit fabric is recommended.

Accessories

Light 50 watt halogen; color: chrome w/black top
Price\$115 ea. w/bag

Roll kit (includes roller, hardware and bag; no graphic)
Price \$78



M2 vs. M4

The difference is in the style; **The M2** is only available in black with chrome ends and the base is a clean block with rounded edges. **The MS4** is only available in chrome and the base is a sleek, elegant shape that is tapered slightly forward.

Both units function the same way. They both have the same unique roller design, adjustable mast, highest quality construction, padded case, light option and accept fabric only.

MediaScreen2 AWD (outdoor)

The Media Screen 2 AWD (All Weather Display) is the outdoor banner stand that carries all the style and features of an indoor premium stand but with tough as nails outdoor hardware. The Media Screen 2 AWD is a double-sided unit tough enough for outdoor weather conditions. The supporting masts and graphics are retracted into the silver-on-chrome base. The unit is designed with a heavy duty base and spring supported mast. Two black padded storage bags are standard with all units.



Do not display your outdoor banners in extreme winds (24-31 mpg or 6ft and higher) and / or thunderstorms. Do not use near overhead wires. Displaying in high winds or near overhead wires may result in property damage, injury or death and any and all existing warranties.



MediaScreen 2 AWD
33.25" w x 76" h
w/Kaleidoscope Select \$787

Pricing (includes graphic, unit and carry bag)

Unit Sizes Available	Live Area	Actual Graphic Print Sizes	MediaScreen2 AWD w/Lambda Bright	MediaScreen2 AWD w/Kaleidoscope Select	MediaScreen2 AWD w/Mesa	MediaScreen2 AWD w/Print-on-it
33.5" w	33.25" w x 70" h	33.25" w x 76" h	N/A	\$787	\$805	\$769

• MicroKnit Recycled fabric: Kaleidoscope Select - \$9/sq. ft. - Colossus 4 color - \$9/sq. ft. - Colossus 8 color - \$10/sq. ft.

Units may be purchased without graphic

33.5" Unit\$495

Discounts for Duplicate Images Only -

The price of the hardware unit is passed on to you at Optima's cost plus shipping and handling and is not discountable. The graphics are discounted based on duplicate volume. To determine the discount for the multiple units, multiply the price for a quantity of one (above) by the following factors:

Quantity	Discount Factor
2-5	.97
6-10	.96
11-15	.95
16-25	.94
26-50	.93
Above 50	Call for quote

Specifications

Shipping Weight

33.5" w Unit with Graphic 36.65 lbs.
(add 2 - 5 lbs. for box and packing)

Shipping Box

33.5" w Unit: 10" x 10" x 36"

Unit Color

Matte Silver on chrome



Accessories

Grip Pegs (set of 4 pegs).....\$25

Grip Pegs only available for the MediaScreen 2 All Weather Display - 4 required

The unit is designed with a heavy duty base and spring supported mast to help outdoors in situations where wind gusts below 20 mph are consistent.

MediaScreen XL

When you have big news, nothing says “look up here” like Media Screen XL. Featuring a massive graphic at a 10’ height, the Media Screen XL is big news for retractable banner stands. The Media Screen XL is a single-sided unit with supporting mast and retractable graphic stored in a silver-on-chrome base. With the many advantages of the XL, it will not be overlooked. A black padded storage bag and 3 segmented bungee pole is standard with all units.

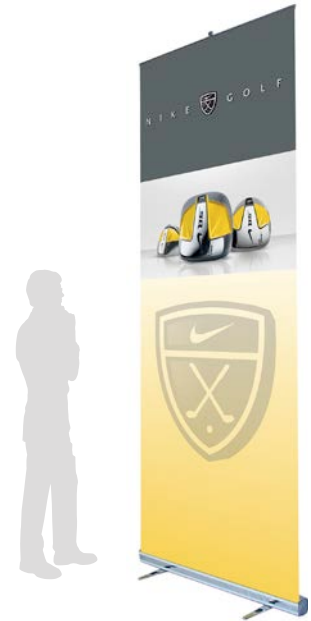

MediaScreen XL 47”w x 123”h w/Kaleidoscope Select \$602

Pricing (includes graphic, unit and carry bag)

Unit Sizes Available	Live Area	Actual Graphic Print Sizes	MediaScreen XL w/Mesa	MediaScreen XL w/Kaleidoscope Select
47.25” w	47”w x 118”h	47”w x 123”h	\$647	\$627

- MicroKnit Recycled fabric: Kaleidoscope Select - \$9/sq. ft. - Colossus 4 color - \$9/sq. ft. - Colossus 8 color - \$10/sq. ft.

Units may be purchased without graphic
47” Unit\$295

Discounts for Duplicate Images Only -

The price of the hardware unit is passed on to you at Optima’s cost plus shipping and handling and is not discountable. The graphics are discounted based on duplicate volume. To determine the discount for the multiple units, multiply the price for a quantity of one (above) by the following factors:

Quantity	Discount Factor
2-5	.97
6-10	.96
11-15	.95
16-25	.94
26-50	.93
Above 50	Call for quote

Specifications

Shipping Weight
47.25” w Unit with Graphic 17.55 lbs.
(add 2 - 5 lbs. for box and packing)

Shipping Box
47.25” w Unit:
10” x 10” x 52”

Accessories

Shipping Cases
50”h x 8”d
.....\$111

Light
50 watt halogen;
available in chrome w/black top\$115 ea. w/bag



PRONTO!™

the precision retractable banner stand

The Pronto Banner Stand is a simple retractable unit with instant set-up. A quality banner stand at the most economical price. When ready to display, simply attach the pole perpendicular to the base and pull the banner up to attach to the top of the mast.

When displayed the graphic is held in place with a clean “clamp style” top hanger for long term reliability and grip. When not in use the graphic retracts into the unit.

The mast stores in the base of the unit and is designed with three even segments for various display options. This makes the Pronto very conducive as a table-top display, just assemble at one or two sections high.

The Pronto is a versatile single-sided unit (double sided available). It comes with an attractive black full zip around padded canvas carry bag with silver accent. The set-up instructions are included right on every unit.

Every Pronto comes with a Lifetime Warranty.

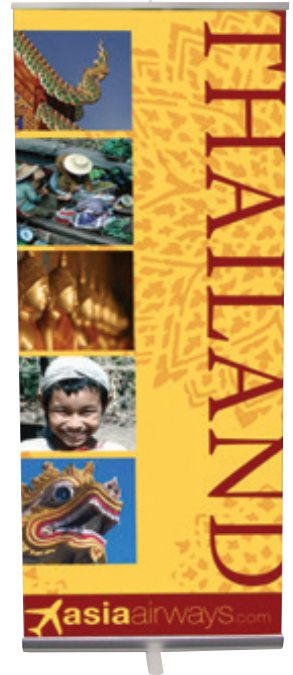

**Pronto 33.25”w x 92”h
w/Kaleidoscope Select \$236**

Pricing (includes graphic, unit and carry bag)

Unit Sizes	Live Area	Actual Graphic Print Sizes	Pronto w/Kaleidoscope Select ¹	Pronto w/Kaleidoscope Select & Diamond Finish	Pronto w/Lambda Bright	Pronto w/Lambda Duraflex or Metallic	Pronto w/Mesa	Pronto w/Paradise
23.5” w	23.25” x 87.25	23.25” x 92”	\$183	\$198	\$220	\$263	\$189	\$225
33.5” w	33.25” x 87.25	33.25” x 92”	\$236	\$257	\$250	\$312	\$248	\$279
39.375” w	39.125” x 87.25	39.125” x 92”	\$273	\$297	\$315	\$387	\$286	\$332
47.25” w	47” x 87.25”	47” x 92”	\$323	\$352	\$360	\$447	\$339	\$397

¹ Price based on Kaleidoscope Select at \$8/sq. ft. Adjust the price as necessary if fabric is more or less than \$8/sq.ft.
 • MicroKnit Recycled fabric: Kaleidoscope Select - \$9/sq. ft. - Colossus 4 color - \$9/sq. ft. - Colossus 8 color - \$10/sq. ft.

Replacement Graphic - With free installation, deduct the following from the above package prices:

- 23.5” Unit\$69
- 33.5” Unit\$72
- 39.375” Unit\$81
- 47.25” Unit\$92



Removable set-up instructions card secured to each unit.



Soft carry bag features heavy padding and full wrap around zipper.

Discounts for Duplicate Images Only

The price of the hardware unit is passed on to you at Optima’s cost plus shipping and handling and is not discountable. The graphics are discounted based on duplicate volume. To determine the discount for the multiple units, multiply the price for a quantity of one by the following factors:

“Pronto Paradise”
Our great Pronto with Paradise fabric.



**Pronto 33.25”w x 92”h
w/Paradise Total As Shown \$279**

Quantity	Discount Factor
2-5	.97
6-10	.96
11-15	.95
16-25	.94
26-50	.93
Above 50	Call for quote

optimagfx.com

PRONTO!™

the precision retractable banner stand

Specifications

Shipping Weight

23.5" Unit w/Graphic 10 lbs.
 33.5" Unit w/Graphic 12 lbs.
 39.375" Unit w/Graphic 14 lbs.
 47.25" Unit w/Graphic 16 lbs.
 (add 2 - 5 lbs. for box and packing)

Unit Colors

Silver and Black

Segmented Pole Heights

For 3 piece pole:
 (33.25", 39.125" and 47" units only)
 - 3 pole height live area from top is 87.25"
 - 2 pole height live area from top is 57.25"
 - 1 pole height live area from top is 30.25"
 For 4 piece pole¹: (23.5 unit only)
 - 4 pole height live area from top is 87.25"
 - 3 pole height live area from top is 65.25"
 - 2 pole height live area from top is 43.25"
 - 1 pole height live area from top is 21.25"

¹ Refer to graphic templates for exact segment sizes.

Graphic specs

Approximately .625" of graphic hides behind top hardware bar.
 Total Banner Stand Height: 89.75".

The 23.5" unit uses a four section pole. Refer to graphic templates for exact segment sizes.

Accessories

Light

50 watt halogen w/attachment clip; available in black or silver....\$59 ea.

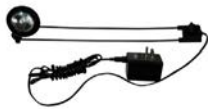

Connector Clip

(only available in silver)....\$11.75 ea.



Light Bag

Black canvas w/ handles; holds 2 lights.....\$30 ea.



Shipping Cases

42"h x 5.5"d\$95 50"h x 8"d\$115



800-844-8877



the easy to use - no tools required, graphic change-out system.

Now you can easily change the graphic on your Pronto Banner Stand! In order to change the graphic yourself, you must order the Pronto equipped with the Change-O and also order the replacement graphic equipped with the Change-O.

The easy to use – no tools required, graphic change-out system.

Unit	Change-O System Cost*	Change-O Replacement Graphic Cost**
Pronto 1	Add \$22 to unit and graphic cost	Add \$28 to unit and graphic cost

* Includes two installed bottom attachment hardware pieces.

** Includes installed bottom attachment piece and top hanger hardware.



The graphic equipped with the Pronto Change-O slides off easily so you can slide the new graphic on.

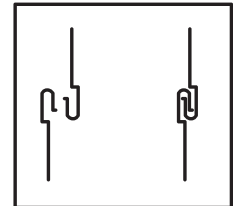

Close-up of the Change-O connection

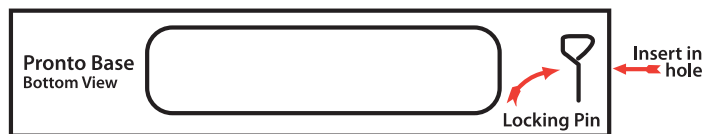

The locking pin is attached to the bottom of the base. To lock the graphic, remove the pin & insert in the hole.

PRONTO! 2TM

the precision retractable banner stand

The Pronto 2 banner stand is a double-sided unit that allows for displaying your message in two directions. Use the two graphics at the same time or independently, depending on your needs. Graphics retract into unit, mast is stored in base of unit and an attractive padded storage bag is included.



Collapsed stand and bungee sectioned mast.



Soft carry bag features heavy padding and full wrap around zipper.



**Pronto2 33.25" w x 92" h
w/Kaleidoscope Select \$427**

Pricing (includes two graphics, unit and carry bag)

Unit Sizes	Live Area	Actual Graphic Print Sizes	Pronto2 w/Kaleidoscope Select ¹	Pronto2 w/Kaleidoscope Select & Diamond Finish	Pronto2 w/Lambda Bright	Pronto2 w/Lambda Duraflex or Metallic	Pronto2 w/Mesa	Pronto2 w/Paradise
23.5" w	23.25" x 87.25	23.25" x 92"	\$322	\$352	\$396	\$482	\$334	\$405
33.5" w	33.25" x 87.25	33.25" x 92"	\$427	\$469	\$455	\$579	\$451	\$513
39.375" w	39.125" x 87.25	39.125" x 92"	\$493	\$541	\$577	\$721	\$519	\$613
47.25" w	47" x 87.25"	47" x 92"	\$581	\$639	\$655	\$829	\$613	\$729

Unit not available without graphic.

¹Price based on Kaleidoscope Select at \$8/sq. ft. Adjust the price as necessary if fabric is more or less than \$8/sq.ft.
 • MicroKnit Recycled fabric: Kaleidoscope Select - \$9/sq. ft. - Colossus 4 color - \$9/sq. ft. - Colossus 8 color - \$10/sq. ft.

Replacement Graphic - With free installation, deduct the following from the above package prices:

- 23.5" Unit\$94
- 33.5" Unit\$99
- 39.375" Unit\$109
- 47.25" Unit\$119

Discounts for Duplicate Images Only -

The price of the hardware unit is passed on to you at Optima's cost plus shipping and handling and is not discountable. The graphics are discounted based on duplicate volume. To determine the discount for the multiple units, multiply the price for a quantity of one (above) by the following factors:

Quantity	Discount Factor
2-5	.97
6-10	.96
11-15	.95
16-25	.94
26-50	.93
Above 50	Call for quote

PRONTO! 2TM

the precision retractable banner stand

Specifications

Shipping Weight

23.5" Unit w/Graphic 12 lbs.
 33.5" Unit w/Graphic 14 lbs.
 39.375" Unit w/Graphic 16 lbs.
 47.25" Unit w/Graphic 18 lbs.
 (add 2 - 5 lbs. for box and packing)

Segmented Pole Heights

For 3 piece pole:
 (33.25", 39.125" and 47" units only)
 - 3 pole height live area from top is 87.25"
 - 2 pole height live area from top is 57.25"
 - 1 pole height live area from top is 30.25"
 For 4 piece pole¹: (23.5 unit only)
 - 4 pole height live area from top is 87.25"
 - 3 pole height live area from top is 65.25"
 - 2 pole height live area from top is 43.25"
 - 1 pole height live area from top is 21.25"

Graphic specs

Approximately .625" of graphic hides behind top hardware bar.

Total Banner Stand Height: 89.75".

The 23.5" unit uses a four section pole. Refer to graphic templates for exact segment sizes.

Unit Colors

Silver and Black

¹ Refer to graphic templates for exact segment sizes.

Accessories

Light

50 watt halogen w/attachment clip; available in black or silver....\$59 ea.

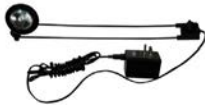

Connector Clip

(only available in silver)....\$11.75 ea.



Light Bag

Black canvas w/ handles; holds 2 lights....\$30 ea.



Shipping Cases

42" h x 5.5" d\$95 50" h x 8" d\$115



800-844-8877



the easy to use - no tools required, graphic change-out system.

Now you can easily change the graphic on your Pronto Banner Stand! In order to change the graphic yourself, you must order the Pronto equipped with the Change-O and also order the replacement graphic equipped with the Change-O.

The easy to use – no tools required, graphic change-out system.

Unit	Change-O System Cost*	Change-O Replacement Graphic Cost**
Pronto 2	Add \$44 to unit and graphic cost	Add \$28 to unit and graphic cost

* Includes two installed bottom attachment hardware pieces.

** Includes installed bottom attachment piece and top hanger hardware.

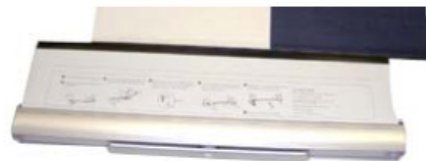

The graphic equipped with the Pronto Change-O slides off easily so you can slide the new graphic on.

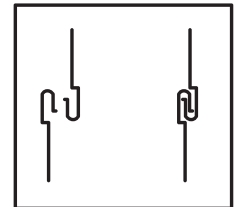

Close-up of the Change-O connection

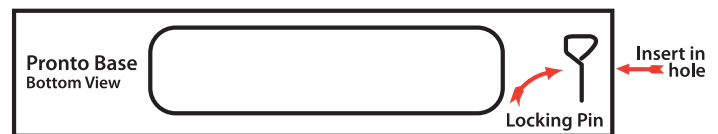

The locking pin is attached to the bottom of the base. To lock the graphic, remove the pin & insert in the hole on the side.

QuickScreen® 1

The Quickscreen series of banner stands is our premier line of roll-up banner stands. When ready to display, simply attach the pole to the base, pull the banner up and attach it to the top of the pole. Set up time is less than 30 seconds. In addition to the standard units shown here, taller poles can be supplied and a larger graphic installed. Please call for a quote. Quickscreen units can be purchased without a graphic.

The Quickscreen 1 banner stand is a versatile single-sided unit with the supporting pole and graphic stored in the base. It is well suited to be used as a tabletop by making it either one or two sections high. An attractive black padded storage bag is included.



**QuickScreen 33.25" w x 91" h
w/Kaleidoscope Select \$375**

Pricing (includes graphic, unit and carry bag)

Unit Sizes Available	Live Area †	Actual Graphic Print Sizes	QuickScreen w/Lambda Bright	QuickScreen w/Kaleidoscope Select ¹	QuickScreen w/Diamond Finish	QuickScreen w/Lambda Duraflex or Metallic	QuickScreen w/Mesa
33.5" w	33.25" x 79"	33.25" x 84"	\$435	\$365	\$392	\$483	\$374
39.5" w	39.125" x 79"	39.125" x 84"	\$539	\$406	\$441	\$574	\$417
33.5" w	33.25" x 86"	33.25" x 91"	\$497	\$375	\$408	\$534	\$386
39.5" w	39.125" x 86"	33.25" x 91"	\$567	\$422	\$460	\$601	\$434

- Cost for MicroKnit Recycled fabric:
Kaleidoscope Select - \$9/sq. ft. - Colossus 4 color - \$9/sq. ft. - Colossus 8 color - \$10/sq. ft.

¹ Price based on Kaleidoscope Select at \$8/sq.ft. Adjust price as necessary if fabric is more or less than \$8.

† To calculate pricing for live area heights not shown:

Add 5" to your graphic live area to accommodate graphic leader. See appropriate price pages (GD-2, GD-3, GL-2 & GL-3) to get graphic cost and add hardware for grand total.

Units may be purchased without graphic

33.5" Unit	\$216
39.375" Unit	\$236

Replacement Graphic - (With free installation)

Deduct the following from the above package prices

33.5" Unit	\$199
39.375" Unit	\$214

Replacement Padded Bags

33.5" Unit	\$67
39.375" Unit	\$75.50

Discounts for Duplicate Images Only -

The price of the hardware unit is passed on to you at Optima's cost plus shipping and handling and is not discountable. The graphics are discounted based on duplicate volume. To determine the discount for the multiple units, multiply the price for a quantity of one (above) by the following factors:

Quantity	Discount Factor
2-5	.97
6-10	.96
11-15	.95
16-25	.94
26-50	.93
Above 50	Call for quote

QuickScreen® 1

Specifications

Shipping Weight

33.5" Unit with Graphic 12 lbs.
(add 2 - 5 lbs. for box and packing)

39.5" Unit with Graphic 15 lbs.
(add 2 - 5 lbs. for box and packing)

Unit Colors

Silver and Black

Segmented Pole Heights

- 79" Live Area Segmented Pole:
 - 3 pole height from top is 79"
 - 2 pole height from top is 50.75"
 - 1 pole height from top is 26.5"
- 86" Live Area Segmented Pole:
 - 3 pole height from top is 86"
 - 2 pole height from top is 56"
 - 1 pole height from top is 28.5"

Adjustable Graphic Heights



3 pole height



2 pole height



1 pole height

Accessories

Light

50 watt halogen;
available in chrome w/ black top....\$115 ea. w/bag



Shipping Cases

42"h x 5.5"d\$95 50"h x 8"d\$115



QuickScreen® 3

If you like the ability to change your graphics from show-to-show, day-to-day, or hour-to-hour, then the Quickscreen 3 is the optimal choice! The graphic cassette stores in the base of the unit and can be easily removed and replaced with a different cassette containing a different graphic on-site in just a matter of seconds.

The unit ships standard with clear accent kits. Enhance your graphic by adding colored accents to your base. Red, Blue and Green are available.

The Superior adjustable telescopic mast makes set-up easy and allows for variable height displays. Unit and pole both store in the black padded bag included. Approximately .5" of graphic is hidden at top inside of hanger bar.



graphic cassette & base

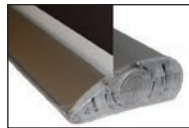

clear endcap



telescopic mast



QuickScreen3
33.25" w x 93.625" h
Kaleidoscope Select \$415

Pricing (includes graphic, unit and carry bag)

Unit Sizes Available	Live Area [‡]	Actual Graphic Print Sizes	QuickScreen3 w/Lambda Bright	QuickScreen3 w/Kaleidoscope Select ¹	QuickScreen3 w/Diamond	QuickScreen3 w/Lambda Duraflex or Metallic	Quick-Screen3 w/Mesa
19.7" w	19.5" x 71"	19.5" x 76"	\$381	\$308	\$323	\$407	\$312
33.5" w	33.25" x 63" - 88.625"	33.25" x 93.625"	\$537	\$415	\$425 [†]	\$574	\$426
39.375" w	39.125" x 63" - 88.625"	39.125" x 93.625"	\$620	\$474	\$486 [†]	\$654	\$487

• Cost for MicroKnit Recycled fabric:

Kaleidoscope Select - \$9/sq. ft. - Colossus 4 color - \$9/sq. ft. - Colossus 8 color - \$10/sq. ft.

[†] Diamond Finish is NOT available in QS3 units with a live area exceeding 80", the graphic will not roll into the cartridge.

¹ Price based on Kaleidoscope Select at \$8/sq.ft. Adjust price as necessary if fabric is more or less than \$8.

[‡] To calculate pricing for live area heights not shown: Add 5" to your graphic live area to accommodate graphic leader. Then multiply total by \$8 sq/ft. and add hardware cost for grand total.

Replacement Graphic - (With free installation)

Deduct the following from the above package prices

- 19.7" Unit\$220
- 33.5" Unit\$239
- 39.375" Unit\$267

Graphics installed in separate cassette

Deduct the following from the above package prices

- 19.7" Unit\$154
- 33.5" Unit\$160
- 39.375" Unit\$182

Replacement Padded Bags

- 19.7" Unit\$59
- 33.5" Unit\$68
- 39.375" Unit\$78.50

Discounts for Duplicate Images Only

The price of the hardware unit is passed on to you at Optima's cost plus shipping and handling and is not discountable.

The graphics are discounted based on duplicate volume. To determine the discount for the multiple units, multiply the price for a quantity of one (above) by the following factors:

Quantity	Discount Factor
2-5	.97
6-10	.96
11-15	.95
16-25	.94
26-50	.93
Above 50	Call for quote

Units may be purchased without graphic

- 19.7" Unit\$240
- 33.5" Unit.....\$261
- 39.375" Unit\$291

NOTE: Matching a Previous Order QS3 banner stand? QS3 manufacturer has made a styling change. Units purchased after 9-8-09 will not match previous generation QuickScreens. We still stock old poles and hanger bars if replacements are needed.

QuickScreen® 3

● Specifications

Shipping Weight

19.7" Unit with Graphic 9 lbs.
 33.5" Unit with Graphic 16.5 lbs.
 39.375" Unit with Graphic 19 lbs.
 (add 2 - 5 lbs. for box and packing)

Assembled Size

(Graphic & Stand)
 19.7" x 75.5" **
 33.5" x 82.5" *
 39.375" x 82.5" *

* 82.5" = size of units with 82" pole.
 * 89.5" = size of unit with 88.5" pole.
 ** 19.7" unit does not come with telescoping pole. It is supplied with a four piece bungee cord pole.

Unit Colors

All Quickscreen 3 units come standard with clear accent kits.

Red, Blue, Green and Chrome accent kits are available. Call your Account representative for availability.

Segmented Pole heights:

4 pole live area from top - 71"
 3 pole live area from top - 52.75"
 2 pole live area from top - 34.75"
 1 pole live area from top - 16.5"

● Accessories

Light

50 watt halogen; available in chrome w/ black top.....\$115 ea. w/bag

Accent Kits

Red, Green and Blue accent kits.....\$28 ea.
 Chrome accent kits.....\$45 ea.



Shipping Cases

50"h x 8"d\$115



SIDEWINDER

When ready to display, simply unfold the attached pole, pull the banner up and attach it to the top of the pole. The Sidewinder is available in a single or double-sided and comes with a padded bag with shoulder strap, Units only available in silver.



Optional header available to apply to the top of your sidewinder unit.



Sidewinder carry bag included



Sidewinder 1 unit (back view)



Sidewinder1 31.5" w x 83" h w/Kaleidoscope Select and 32" w x 7" h header graphic \$383

Pricing (includes graphic, unit and carry bag)

Sidewinder1

Units may not be purchased without a graphic

Unit Sizes Available	Live Area	Sidewinder1 w/Lambda Bright	Sidewinder1 w/Kaleidoscope Select	Sidewinder1 w/Diamond Finish	Sidewinder1 Lambda Duraflex or Metallic	Sidewinder1 w/Mesa
24" w	23.5" x 83"	\$379	\$311	\$332	\$400	\$317
32" w	31.5" x 83"	\$435	\$357	\$385	\$468	\$366
39.5" w	39.4" x 83"	\$529	\$431	\$466	\$561	\$442
47.5" w	47.25" x 83"	\$614	\$507	\$549	\$688	\$521

Sidewinder2¹

Unit Sizes Available	Live Area	Sidewinder2 w/Lambda Bright	Sidewinder2 w/Kaleidoscope Select	Sidewinder2 w/Diamond Finish	Sidewinder2 w/Lambda Duraflex or Metallic	Sidewinder2 w/Mesa
24" w	23.5" x 83"	\$594	\$458	\$500	\$636	\$471
32" w	31.5" x 83"	\$751	\$595	\$651	\$817	\$614
39.5" w	39.4" x 83"	\$859	\$633	\$733	\$923	\$655
47.5" w	47.25" x 83"	\$1,118	\$904	\$988	\$1,186	\$932

¹ Sidewinder 2 units contain two graphics.

- MicroKnit Recycled fabric: Kaleidoscope Select - \$9/sq. ft. - Colossus 4 color - \$9/sq. ft. - Colossus 8 color - \$10/sq.ft.

Replacement Graphic - (With free installation)

Deduct the following from the above package prices

- 24" Sidewinder 1.....\$200
- 32" Sidewinder 1.....\$209
- 39.5" Sidewinder 1.....\$245
- 47.5" Sidewinder1\$285
- 24" Sidewinder 2.....\$236
- 32" Sidewinder 2\$299
- 39.5" Sidewinder 2\$291
- 47.5" Sidewinder 2\$460

Discounts for Duplicate Images Only

The price of the hardware unit is passed on to you at Optima's cost plus shipping and handling and is not discountable. The graphics are discounted based on duplicate volume. To determine the discount for the multiple units, multiply the price for a quantity of one by the following factors:

Header Graphics (optional) - Print-on-it or Lambda on 1/4" black or white sintra. (Price below based on single sided direct print to sintra profile.)

Size: 32"w x 7"h \$26
 Other header sizes available for other units call for a quote.

Quantity	Discount Factor
2-5	.97
6-10	.96
11-15	.95
16-25	.94
26-50	.93
Above 50	Call for quote



Roll Up Classic system is easy to transport and assembles in a flash for your presentation. Roll Up Classic is available in a wide range of widths and is ideal for repeated use in different indoor environments.



Roll Up Classic 39" w x 89" h w/Microknit \$372

Pricing (includes graphic, unit and carry bag)

Unit Sizes Available	Live Area	Final Size	Roll Up Classic w/Microknit	Roll Up Classic w/Lambda Bright	Roll Up Classic w/Lambda Duraflex or Metallic	Roll Up Classic w/Mesa
27"	27" x 76.625"	27" x 81.125"	\$273	\$364	\$392	\$280
33"	33" x 84.5"	33" x 89"	\$328	\$444	\$482	\$339
39"	39" x 84.5"	39" x 89"	\$372	\$503	\$538	\$383
44.75"	44.75" x 84.5"	44.75" x 89"	\$416	\$560	\$598	\$431
56.5"	56.5" x 84.5"	56.5" x 89"	\$524	N/A	N/A	N/A



Carry Bag

Replacement Graphic - (With free installation)

- w/o roller - determine price from fabric price list and add \$15.
- w/roller - add \$30 to graphic price for all units except 56.5" unit. Add \$40 to graphic price for 56.5" unit.

Qty	Discount Factor
2-5	.97
6-10	.96
11-15	.95
16-25	.94
26-50	.93
Above 50	Call for quote

Specifications

Shipping Weight

- 27" Unit only 4.2lbs.
- 33" Unit only 5.5lbs.
- 39" Unit only 5.9lbs.
- 44.75" Unit only 9lbs.
- 56.5" Unit only 10.4lbs.
- (add 2 - 5 lbs. for box and packing)

Optional Accents

Available in blue, red, yellow and black.
 Price \$25
 Call for availability.

Print Process

- Dyesub (Select/Colossus)
- Lambda
- Print-on-it

Unit Color

Silver available for all sizes
 Black available for 33" and 39" units

Accessories

Light

50 watt halogen; available in silver & black....\$59 ea.

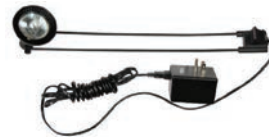

Shipping Cases

50"h x 12"d \$110
 (56.5" unit will fit in the 72"h x 12"d case...\$150.
 Call for details.)

Light Bag

Black canvas w/ handles; holds 2 lights.....\$30 ea.



the set

Retractable Banners Stand

The Set retractable banner stand delivers your message with a sleek design. Made of anodized aluminum the clipping hanger bar provides excellent rigidity, which prevents wrinkling or crimping of your graphic, even with strong tension in the retractor.

The telescopic pole is light compatible and allows you to adjust the graphic height between 35" and 90". Rounding out the features of The Set is a pivoting and self-locking foot for unmatched stability.



Set Banner Stand 31.5" w x 90" h w/Microknit \$343

Pricing (includes graphic, unit and carry bag)

Unit Sizes Available	Live Area	Final Size	Set Banner Stand w/Microknit 90" h	Set Banner Stand w/Diamond Finish 90" h	Set Banner Stand w/Mesa 90" h	Set Banner Stand w/Lambda Bright 90" h	Set Banner Stand w/Lambda Duraflex 90" h
24.375"	23.625" x 35" to 90"	23.625" x 41" to 96"	\$297	\$321	\$305	\$390	\$421
32.25"	31.5" x 36" to 90"	31.5" x 42" to 96"	\$343	\$375	\$354	\$462	\$500
40.3125"	39.5625" x 37" to 90"	39.5625" x 43" to 96"	\$394	\$434	\$407	\$535	\$569
48"	47.25" x 38" to 90"	47.25" x 44" to 96"	\$449	\$496	\$465	\$610	\$666

Units may be purchased without graphic

- 24.375" Unit\$171
- 32.25" Unit\$175
- 40.3125" Unit\$183
- 48" Unit\$197

Specifications

Shipping Weight

- 24.375" Unit only 6lbs.
- 32.25" Unit only 7lbs.
- 40.3125" Unit only 8lbs.
- 48" Unit only 10lbs.
- (add 2 - 5 lbs. for box and packing)

Print Process

- Dyesub (Select/Colossus)
- Lambda
- Print-on-it

Unit Color

- Charcoal with chrome ends

Graphics Pole

- Telescoping



Accessories

Light

50 watt halogen; available in silver & black....\$59 ea.

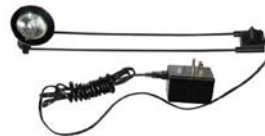

Light Bag

Black canvas w/ handles; holds 2 lights....\$30 ea.



Shipping Cases

50" h x 8" d\$115



Media Screen 3

The Media Screen 3 is a great choice if you want to change your graphics from show-to-show, daily, or even hourly. The graphic cartridge stores in the base of the unit and can be easily removed by flipping two clips. Change out your message with a different cartridge containing a different graphic while in the field in just a matter of seconds.

The Media Screen 3 has an adjustable telescopic pole that makes set-up easy and allows for variable height displays. An adjustable pole holder in the base helps to keep your graphic standing straight and tall.

Unit and telescoping pole both store in the black hard shipping case that is included in the price.



telescopic mast adjustable pole holder removable graphic cartridge

MediaScreen3
33.25" w x 93.625" h
Kaleidoscope Select \$513

Pricing (includes graphic, unit & hard shipping case)

Unit Sizes Available	Live Area ‡	Actual Graphic Print Sizes	MediaScreen3 w/Lambda Bright	MediaScreen3 w/Kaleidoscope Select ¹	MediaScreen3 w/Diamond Finish	MediaScreen3 w/Lambda Duraflex or Metallic	Media Screen3 w/Mesa
33.25" w	33.25" x 63" - 88.625"	33.25" x 68" - 93.625"	\$637	\$513	\$517 [†]	\$674	\$524

* Recycled Microknit cost: Kaleidoscope Select - \$9/sq. ft. - Colossus 4 color - \$9/sq. ft. - Colossus 8 color - \$10/sq. ft.

‡ To calculate pricing for live area heights not shown for **Fabric graphics**: Add 5" to your graphic live area to accommodate graphic leader. Then multiply total by \$8 sq/ft. (**Diamond Finish**: \$9.50 sq/ft) and add hardware cost for grand total.

For **Lambda graphics** use pricing tables on page GL-2 or GL-3.

¹ Price based on Kaleidoscope Select at \$8/sq.ft. Adjust price as necessary if fabric is more or less than \$8.

[†] Diamond Finish is NOT available in MS3 units with a live area exceeding 80", the graphic will not roll into the cartridge.

Units may be purchased without graphic
 33.25" Unit.....\$340

Graphics installed in separate cassette
 Deduct the following from the above prices
 33.5" Unit\$235

Discounts for Duplicate Images Only	Quantity	Discount Factor
The price of the hardware unit is passed on to you at Optima's cost plus shipping and handling and is not discountable. The graphics are discounted based on duplicate volume. To determine the discount for the multiple units, multiply the price for a quantity of one (above) by the following factors:	2-5	.97
	6-10	.96
	11-15	.95
	16-25	.94
	26-50	.93
	Above 50	Call for quote

Specifications

Unit Colors

Matte silver base with ruby black endcaps

Weight

- Unit & Graphic: 9 lbs.
- Unit & Graphic in Case: 16 lbs.

Unit Dimensions

- Set up: 35.25" x 8" x (height of graphic + 3")
- Collapsed: 8" x 3" x 35.25"

Hard shipping case

(Included in price)
 Dimensions: 5" x 11.5" x 35.5"
 Weight: 7 lbs.



Accessories

Light

50 watt halogen; available in chrome w/black top\$115 ea. w/bag



Spennare Roll Up S10 Wide

Probably the most graceful and convenient retractable banner system on the market! Roll Up S10 has a well defined and discreet design that lets the message speak for itself. Enjoy low weight, high quality and great usability. The foot is discreet and the cassette, which protects the message when not in use, is compact.



Spennare Roll Up S10 Wide
59" w x 86" h with Microknit \$739

Pricing (includes graphic, unit & carry bag)

59" unit with Select Microknit Graphic \$739

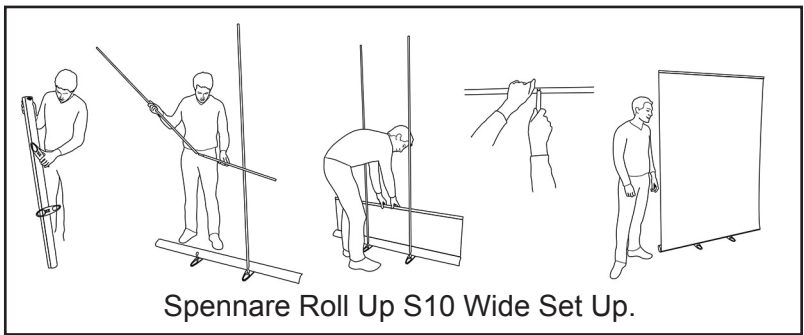

Spennare Roll Up S10 Wide Back view showing two retractable poles.

Specifications

Graphic Dimensions:

59.06" x 86.61"

Add 6" to bottom for attaching to leader strip.

Frame Material:

Aluminum

Frame Weight:

59" 18lbs.

Accessories

Light w/bag (50watt)

Price \$85 each



The Alfresco banner stand is designed for outdoor banner applications. It is specially designed to withstand rugged outdoor conditions including winds and rain. The base has a lightweight tank with an easy-fill water or sand opening (water or sand not included). The durable, click-stop mast provides a secure, balanced structure that sets up in minutes and stays put. A bulls-eye locking system in each corner maintains a flat, even shape. Kaleidoscope Select Sports Mesh is strongly recommended for use on the Alfresco system. Sports Mesh is extremely wind resistant ... perfect for outdoors!



**Alfresco 41" w x 80" h
w/Kaleidoscope Select \$342**

Pricing (includes graphic, unit and carry bag)

Single Sided Graphic Cost (Sports Mesh)

Unit Sizes Available	Graphic Print Sizes	Graphic Final Sizes	Alfresco w/Kaleidoscope Select
16" w, 19" deep	26" - 41" w x 62" - 80" h	24" - 39" w x 60" - 78" h	\$342 (41" x 80")

For a non-standard graphic size, determine the graphic price from the appropriate price list.

Units may be purchased without graphic
Single Sided\$160

Wind Slits
(not necessary on Sports Mesh).....\$15 ea



Back Side

Specifications

Unit
Weight with water
in base42lbs.

Shipping Weight
Unit with Graphic 7 lbs.
(add 2 - 5 lbs. for box
and packing)

Unit Color
Grey



Durable, Compact
Soft Carrying
Case
Included



Do not display your outdoor banners in extreme winds (24-31mpg or 6ft and higher) and / or thunderstorms. Do not use near overhead wires. Displaying in high winds or near overhead wires may result in property damage, injury or death and any and all existing warranties.



display in a new direction
compass™

Compass is a lightweight banner stand with some very cool features. An X-Style banner hub mounted to a telescopic mast with a sturdy flat base. Four practical rectangular graphic sizes are available. The banner-to-mast mount utilizes an innovative hub. The hub allows the banner to rotate at different angles as well as tilt up or down. Combine with a table throw for a unique table top display.

The Compass floats above your table allowing for full use of table top space. Multiple Compass bannerstands can be used in concert to create exciting backwalls. Angle multiple banners to attract attention. Pivot your banner so your message can be seen from multiple vantage points. Compass can be used at multiple heights for all occasions and applications. Easy to set up and use, Compass will keep your message fresh and on the right course to attract your audience.



Shown behind a six foot table.

Pricing (includes graphic, unit and carry bag)

Final Size	Live Area (Between the sew lines)	Print size (Includes bleed)	Compass w/Kaleidoscope Select Microknit ¹
36" x 60"	34" x 58"	38" x 62"	\$251
36" x 78"	34" x 76"	38" x 80"	\$289
40" x 75"	38" x 73"	42" x 77"	\$300
48" x 72"	46" x 70"	50" x 74"	\$320

Compass 38" w x 62" h w/Kaleidoscope Select \$251

¹ Price based on Kaleidoscope Select at \$8/sq.ft. Adjust price as necessary if fabric is more or less than \$8.

- MicroKnit Recycled fabric: Kaleidoscope Select - \$9/sq. ft. - Colossus 4 color - \$9/sq. ft. - Colossus 8 color - \$10/sq. ft.
- Celtic Recycled fabric - \$9/sq. ft.

Units may not be purchased without a graphic.

Replacement Graphic - (With free installation)

- 36" x 60" unit.....\$131
- 36" x 78" unit.....\$169
- 40" x 75" unit.....\$180
- 48" x 72" unit.....\$200



Multiple units used to create backwalls.

Specifications

Shipping Weight

One Unit with Graphic 14lbs.
Two Units with Graphics 23lbs.
(add 2 - 5 lbs. for box and packing)

Component Weights

Unit 6.5lbs.
Unit & Graphic 10lbs.

Shipping Box

10" x 10" x 45"
(can hold 2 units)

Unit Dimensions

Collapsed w/black carry bag
11" w x 44" h x 4.5" d

Unit Color

Silver



Compass Hub view.

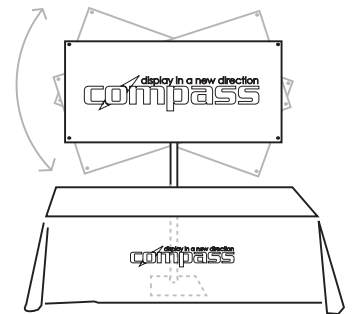

Compass mates up perfectly behind and over a table. Frees up the entire table top for your products, literature and more!

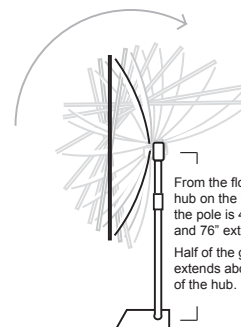

From the floor to center of the hub on the back the height of the pole is 43.5" collapsed and 76" extended.
Half of the graphic height extends above the center of the hub.

Banner can be tilted forward or backward. Project your message to a higher level platform or tilt downward to a lower level.

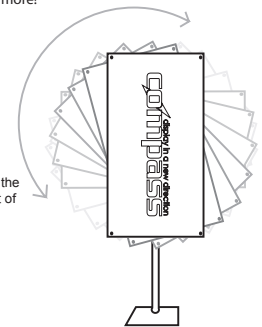

Banner can be rotated and locked into any position. Display at an angle and see how many heads turn!

Concierge™

literature rack and banner stand

The Concierge is a two pocket compact and stylish brochure holder with graphic underneath. The two pocket brochure holder is made of black mesh and can hold multiple 8.5" x 11" product literature pieces. This gives you the advantage to promote your message with literature along with an eye catching graphic. The graphic is held securely in place with aluminum hardware. The Concierge is easy to set up and small enough to fit almost anywhere.

Swap the brochure holder to the bottom, combine two or more units and create a functional and effective table top display.

When ordering a Concierge with a full size graphic you will still receive a lit holder. The lit holder is part of the standard kit inventory.



Concierge
 19.6875" w x 36.8125" h
 w/Kaleidoscope Select \$150

Pricing (includes graphic, unit and carry bag)

Unit Sizes Available	Live Area	Actual Graphic Print Sizes	Lambda	Concierge w/Kaleidoscope Select
19.6875" w x 54"h	19.6875" w x 36.8125"h	19.6875" w x 37.25"h	\$189	\$150
19.6875" w x 54"h	19.6875" w x 53.5625"h	19.6875" w x 54"h	\$215	\$168

Units may not be purchased without a graphic

- 1 Price based on Kaleidoscope Select at \$8/sq.ft. Adjust price as necessary if fabric is more or less than \$8.
- MicroKnit Recycled fabric: Kaleidoscope Select - \$9/sq. ft. - Colossus 4 color - \$9/sq. ft. - Colossus 8 color - \$10/sq. ft.



Combine 3 on table top for a great display.

Concierge back view.



Specifications

Shipping Weight
 Unit with Graphic 4.25 lbs.
 (add 2 - 5 lbs. for box and packing)

Unit Color Pole Color
 Chrome Blue

Literature holder
 2 pocket black mesh brochure holder and canvas bag. Each pocket can hold 8.5" x 11" literature pieces

Literature Holder Color.....Black Mesh

Accessories

Light
 50 watt halogen; available in chrome w/ black top....\$115 ea. w/bag



Courier™

The Courier is a lightweight portable banner stand with zero distracting framework to take away from your advertising message. A tubular base with dual support feet and a four-piece shock corded pole support the graphic in an upright position.

Unit not available without graphic.



**Courier 32.5" w x 88.5" h
w/Kaleidoscope Select \$181**

Pricing (includes graphic and unit)

Unit Size	Live Area	Graphic Print Size	Final Size
33" w	32.5" w x 86" h	32.5" w x 88.5" h	33" w x 88" h

Quantity*	Courier w/Lambda Bright	Courier w/Lambda Duraflex & Metallic	Courier Kaleidoscope Select ¹
1	\$279 ea	\$317 ea	\$181 ea
2 - 5	\$252 ea	\$285 ea	\$167 ea
6 - 15	\$244 ea	\$276 ea	\$163 ea
16 - 25	\$239 ea	\$270 ea	\$160 ea
26 - 50	\$225 ea	\$255 ea	\$149 ea
51 - 99	\$212 ea	\$240 ea	\$142 ea
100 +	Call for quote	Call for quote	Call for quote

The Courier is easy to transport and set-up.



Units may not be purchased without a graphic.

- MicroKnit Recycled fabric: Kaleidoscope Select - \$9/sq. ft. - Colossus 4 color - \$9/sq. ft. - Colossus 8 color - \$10/sq. ft. Custom sizes are also available. Please call for quote.

¹ Price based on Kaleidoscope Select at \$8/sq.ft. Adjust price as necessary if fabric is more or less than \$8.

* Quantity discount based on duplicate images only.

Specifications

Shipping Weight

32" w Unit with Graphic 5 lbs.
(add 2 - 5 lbs. for box and packing)

Shipping Box

32" w Unit: 6" x 6" x 36"

Unit Footprint

16" d x 33" w

Unit Color

Black

Accessories

Carry Bag

Black carrying bag.....\$15

Black carrying bag with company Logo.....\$60



Courier back view.



eco-1st BAMBOO™ L-stand

Eco-1st Bamboo L-Stand is as beautiful as it is eco friendly. Created from sustainable bamboo resources and outfitted with MircoKnit recycled graphics, Bamboo L-stand is the ultimate convergence in style, quality and global responsibility.

MicroKnit recycled graphics use the water based Kaleidoscope Select process to produce crisp brightly colored images. Sharp flat recycled fabric graphics and gorgeously finished natural bamboo hardware project this retractable into a class of it's own. Combine several L-stands to create a green friendly backwall that will compete with the best looking options on the market.

Whether you are meeting your organizations green initiatives, exercising your own awareness or simply looking for a great looking simple bannerstand or full backwall system the Bamboo L-stand is a great choice!

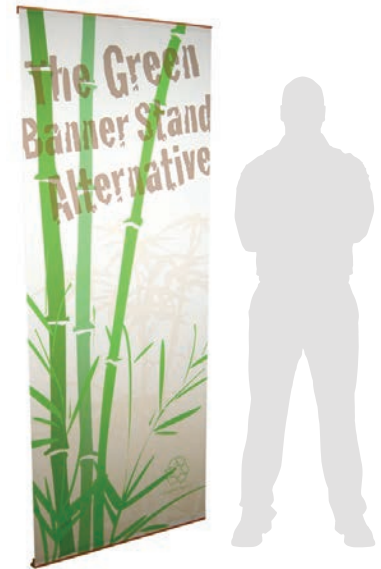

Bamboo L-Stand
31.5" w x 81" h w/Kaleidoscope Select Recycled MicroKnit \$265

Pricing (includes graphic, unit and carry bag)

Unit Size	Live Area	Graphic Print Size	Final Size	Bamboo L-Stand w/Kaleidoscope Select Recycled MicroKnit
32.375" w	31.5" w x 77.25" h	31.5" w x 81" h	31.5" w x 78.75" h	\$265

Units may not be purchased without a graphic

Replacement Graphic - With free installation, deduct the following from the above package prices:
32.5" Unit\$155

Discounts for Duplicate Images Only

The price of the hardware unit is passed on to you at Optima's cost plus shipping and handling and is not discountable. The graphics are discounted based on duplicate volume. To determine the discount % for the multiple units, multiply the price for a quantity of one (above) by the following factors:

Quantity	Discount Factor
2-5	.97
6-10	.96
11-15	.95
16-25	.94
26-50	.93
Above 50	Call for quote

Specifications

Unit

- Open: 32.25" w x 79.5" h x 16" d
- Collapsed: 32.375" h x 5.25 diameter
- Material: Bamboo
- Finish: Natural Wood
- Carry Bag: Green cotton - included with graphic & unit pricing

Shipping Weight

Unit with Graphic 5.85 lbs.
(add 2 - 5 lbs. for box and packing)

Shipping Box

Size: 6" x 6" x 36"



Green Cotton carry bag included



Eco-1st Bamboo L-stand back view.

The Multiplier™

The Multiplier is a lightweight portable banner stand. The hardware includes a sturdy plastic foot and flexible, carbon fiber pole. Top and bottom profiles allow graphics to be changed with ease. The Multiplier comes with a black, nylon carrying bag. Perfect in execution and price for high quality orders.



The Multiplier 32" w x 81" h w/Kaleidoscope Select \$174

Pricing (includes graphic, unit and carry bag)

Unit Size	Live Area	Graphic Print Size	Final Size	The Multiplier w/Kaleidoscope Select
32" w	32"w x 79"h	32"w x 81"h	32"w x 81"h	\$174

Units may not be purchased without a graphic

- MicroKnit Recycled fabric: Kaleidoscope Select - \$9/sq. ft. - Colossus 4 color - \$9/sq. ft. - Colossus 8 color - \$10/sq. ft

Unit Cost

Determine your quantity and add the appropriate price below for stand and nylon bag to your graphic cost.

<u>Number of Units</u>	<u>Price For Unit & Bag Only</u>
1 - 50	\$30 each
51 - 100	\$26 each
101 - 1000	\$23 each
1000 +	\$20 each

The Multiplier back view.



Specifications

Shipping Weight

32" w Unit with Graphic 17.55 lbs.
(add 2 - 5 lbs. for box and packing)

Shipping Box

32" w Unit: 6" x 6" x 36"

Base Footprint

16" d x 32" w

Unit Color

Black or Silver

Accessories

Optional carrying case

5 3/4" diameter x 40 1/4" long
(will hold graphic and stand /
(not discountable)..... \$25

Nylon bag.

Only holds the unit the graphic will not store in this bag. Included .





4 Screen is a cost-effective way of getting your message across on a large scale. Perfect for indoor events and major campaigns where everything from price to assembly time is crucial. Available in six widths. The design is discreetly simple and you can put it up in less than a minute. Despite its low weight, the 4 Screen stands perfectly steady.



Combine TWO or more units to create exciting backwalls.



4 Screen Classic 33.4375" w x 85" h w/Microknit \$243

Pricing (includes graphic, unit and carry bag)

Unit Sizes Available	Live Area	Final Size	4 Screen Classic w/Microknit	4 Screen Classic w/ Lambda Bright	4 Screen Classic w/ Lambda Duraflex/Metallic
21.625"	21.625" x 58.3125"	21.625" x 58.875"	\$146	\$212	\$233
27.5"	27.5" x 76.625"	27.5" x 77.015625"	\$197	\$293	\$321
33.4375"	33.4375" x 84.5"	33.4375" x 85"	\$243	\$354	\$392
39.375"	39.375" x 84.5"	39.375" x 85"	\$277	\$406	\$442
45.25"	45.25" x 84.5"	45.25" x 85"	\$353	\$497	\$534
57.09375" *	57.09375" x 84.5"	57.09375" x 85"	\$421	N/A	N/A

*57" unit will not work with Shipping Case

Qty	Discount Factor
2-5	.97
6-10	.96
11-15	.95
16-25	.94
26-50	.93
Above 50	Call for quote

Replacement Graphics (Includes 2 aluminum profile strips)
 Add \$10 to graphic cost for all units 57" unit.
 Add \$20 for the 57" units only.

Specifications

Shipping Weight
 21.625" Unit only 4.2lbs.
 27.5" Unit only 4.8lbs.
 33.437" Unit only 5.5lbs.
 39.375" Unit only 5.9lbs.
 45.25" Unit only 9lbs.
 57.093" Unit only 10.4lbs.
 (add 2 - 5 lbs. for box and packing)

Print Process
 Dyesub (Select/Colossus)
 Lambda

Unit Color
 Silver

Accessories

Light
 50 watt halogen; available in silver & black....\$59 ea.

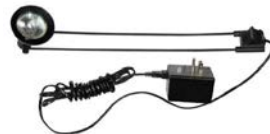

Shipping Cases
 50" h x 8" d\$115

Light Bag
 Black canvas w/ handles; holds 2 lights....\$30 ea.



sprint®

The Sprint is an adjustable portable banner stand. Just open the carrying case, put the unit on the floor, attach the graphic, and adjust the height. The Sprint features a three-piece elliptical telescoping pole with a spin-lock mechanism to adjust the mast and panel height up to 98". Sprint units can be single or double-sided. A 50w Halogen spot-light with case and literature holders are available. The new "Fixture Adapter" allows you to display items with your message. Rigid substrates with profiled graphics can be used on the Sprint. All units are silver. A canvas bag is available for transporting the Sprint.

NEW Sprint Features:



Adjustable Ring



Foot Adapter Lock



Improved Design

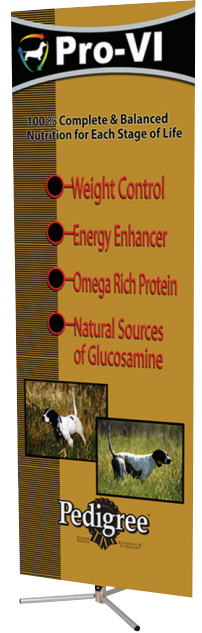

**Sprint 31.5" w x 78" h
w/Kaleidoscope Select \$231**

Pricing (includes graphic and unit)

Graphic Size	Sprint w/Kaleidoscope Select Microknit ¹	Sprint w/Lambda Bright	Sprint w/Lambda Duraflex & Metallic
31.5" w x 78" h	\$231	\$328	\$361
31.5" w x 98" h	\$264	\$379	\$417
39.375" w x 60" h	\$224	\$319	\$350
47.25" w x 98" h	\$348	\$513	\$572

- ¹ Price based on Kaleidoscope Select at \$8/sq.ft. Adjust price as necessary if fabric is more or less than \$8.
- MicroKnit Recycled fabric: Kaleidoscope Select - \$9/sq. ft. - Colossus 4 color - \$9/sq. ft. - Colossus 8 color - \$10/sq. ft.
 - For graphic sizes & prices other than those listed above, please determine prices from appropriate price list.
 - For double-sided Sprint, add \$12 for hardware to the cost of the 2nd graphic.
 - Custom sized graphics are available; add \$10 per graphic to the hardware price above for custom hardware.

Units may be purchased without graphic
 Unit w/Hanging Hardware \$92 Unit w/o Hanging Hardware \$80



Sprint with Fixture Adapter Accessory



Sprint with Literature holder

Discounts for Duplicate Images Only
 The price of the hardware unit is passed on to you at Optima's cost plus shipping and handling and is not discountable. The graphics are discounted based on duplicate volume. To determine the discount % for the multiple units, multiply the price for a quantity of one (above) by the following factors:

Quantity	Discount Factor
2-5	.97
6-10	.96
11-15	.95
16-25	.94
26-50	.93
Above 50	Call for quote

sprint®

Specifications

Shipping Weight
Unit with Graphic 8 lbs.
(add 2 - 5 lbs. for box
and packing)

Unit Color
Silver

Unit Heights
44" Collapsed
99" Fully Extended

Unit Specification
Will accommodate two
lights for a double-sided
graphic unit.

Fixture Adapter Weight Limit
15 lbs. Maximum

Fixture Adapter Specifications
Adapter accepts a variety of hooks, shelves,
baskets, etc. The following fixtures are in
stock, but you can use fixtures from your local
store, or you can contact one of the following:
www.fixtures-displays.com 1-800-8215748
www.omahafixture.com 1-800-531-6627
www.storefix.com 1-877-570-2001

Accessories

Light
50 watt halogen w/attachment clip;
available in black or silver....\$59 ea.

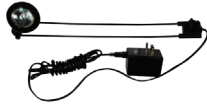

Fixtures in Stock
12" L x 8" W x 4" D Black Wire Basket \$8
12" L x 8" W x 4" D White Wire Basket \$8



10" L x 4" W Clear Plastic Shelf \$3
12" L x 6" W Clear Plastic Shelf \$4



Light Bag
Black canvas w/ handles; holds 2
lights\$30 ea.



Single Hat/Cap Display \$3



5 J-Hook Waterfall \$5



6 Ball Waterfall \$5



8" Peg Hook / Chrome Finish \$2



4" Peg Hook / Chrome Finish \$2



- Customer is responsible for cutting the graphic
for the Fixture Adapter accessory.

Literature Holders
4" x 5 3/4" single\$26 ea.*

8 3/4" x 9 1/4" single\$30 ea.

4" x 11 1/2" single\$26 ea.*

* Item is discontinued and
inventory is limited.

Shipping Cases
"O" Case 39.5".....\$115 "O" Case 50.75".....\$120

Carry Cases
44"h x 5"d Carrying
Case\$15

47.25"h x 5"d Carrying
Case\$25

Fixture Adapter
15 3/8"w x 8 1/8"h\$82 ea.





The Summit is a portable banner stand with a three-piece telescoping pole and spin-lock mechanisms which allow for adjustable mast and panel height up to 96" Set the unit on the floor, attach the graphic, and adjust the height. Simply twist the spin-lock mechanism and slide the base collar up and down. No tools needed. 50w halogen spotlight and literature holders are available. All units available in silver and black. The Summit can be a single or double sided unit. Rigid Substrates with profiled graphics can be used on the Summit.

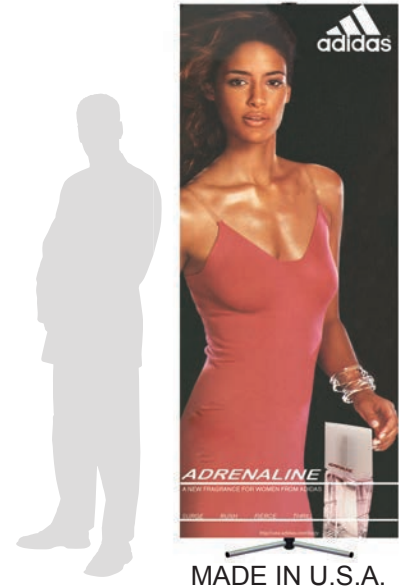

Pricing (includes graphic and unit)

Graphic Size	Summit w/Kaleidoscope Select Microknit ¹	Summit w/Lambda Bright	Summit w/Lambda Duraflex & Metallic
24"w x 30"h	\$142	\$183	\$200
32"w x 40"h	\$163	\$229	\$250
32"w x 78"h	\$231	\$328	\$361
39.5"w x 60"h	\$225	\$319	\$350
48"w x 96"h	\$348	\$513	\$572

- ¹ Price based on Kaleidoscope Select at \$8/sq.ft. Adjust price as necessary if fabric is more or less than \$8.
- MicroKnit Recycled fabric: Kaleidoscope Select - \$9/sq. ft. - Colossus 4 color - \$9/sq. ft. - Colossus 8 color - \$10/sq. ft.
 - For graphic sizes & prices other than those listed above, please determine prices from appropriate price list. Minimum graphic cost is \$50.
 - For double-sided Summit, add \$12 for hardware to the cost of the 2nd graphic.
 - Custom sized graphics are available; add \$10 per graphic to the hardware price above for custom hardware.

Units may be purchased without graphic
 Unit w/Hanging Hardware \$92
 Unit w/o Hanging Hardware \$80



Discounts for Duplicate Images Only

The price of the hardware unit is passed on to you at Optima's cost plus shipping and handling and is not discountable. The graphics are discounted based on duplicate volume. To determine the discount for the multiple units, multiply the price for a quantity of one by the following factors:

Quantity	Discount Factor
2-5	.97
6-10	.96
11-15	.95
16-25	.94
26-50	.93
Above 50	Call for quote



● Specifications

Shipping Weight
Unit with Graphic 8 lbs.
(add 2 - 5 lbs. for box
and packing)

Unit Heights
39" Collapsed
96" Fully Extended

Unit Colors
Silver

Unit Specification
Will accommodate two
lights for a double-sided
graphic unit.

● Accessories

Light
50 watt halogen w/attachment clip;
available in black or silver....\$59 ea.

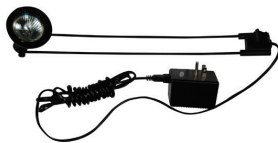

Carry Cases
40.5"h x 5 3/4"d Carrying Case.....\$25
48"h x 5 3/4"d Carrying Case.....\$35

Light Bag
Black canvas w/ handles; holds 2
lights....\$30 ea.



Shipping Cases
"O" Case 39.5".....\$115 "O" Case 50.75".....\$120

Literature Holders
5"\$26 ea.





The "Summit Style" is a portable banner stand perfect for long-term or permanent displays. The 11" flat, round, base takes up minimal space and is great for high-traffic areas – nothing for people to step over. The telescoping pole features a spin-lock mechanism, which allows for adjustable mast and panel height up to 96". Simply screw the pole into the base plate, attach the graphic, and adjust the height. No tools necessary. A 50w halogen spotlight and literature holders are available. All units are available in silver and black. The Summit Style can be single or double sided. Rigid Substrates with profiled graphics can be used on the Summit Style.



Telescoping pole and base.



MADE IN U.S.A.

Summit Style 32"w x 78"h w/Kaleidoscope Select \$264

Pricing (includes graphic, unit and carry bag)

Graphic Size	Summit style w/Kaleidoscope Select Microknit ¹	Summit style w/Lambda Bright	Summit style w/Lambda Duraflex & Metallic
24"w x 30"h	\$175	\$216	\$233
32"w x 40"h	\$196	\$262	\$283
32"w x 78"h	\$264	\$361	\$394
39.5"w x 60"h	\$258	\$352	\$383
48"w x 96"h	\$381	\$546	\$605

- ¹ Price based on Kaleidoscope Select at \$8/sq.ft. Adjust price as necessary if fabric is more or less than \$8.
- MicroKnit Recycled fabric: Kaleidoscope Select - \$9/sq. ft. - Colossus 4 color - \$9/sq. ft. - Colossus 8 color - \$10/sq. ft.
- For graphic sizes & prices other than those listed above, please determine prices from appropriate price list. Minimum graphic cost is \$50.
- For double-sided Summit, add \$12 for hardware to the cost of the 2nd graphic.
- Custom sized graphics are available; add \$10 per graphic to the hardware price above for custom hardware.

Units may be purchased without graphic

Unit\$125

Discounts for Duplicate Images Only

The price of the hardware unit is passed on to you at Optima's cost plus shipping and handling and is not discountable. The graphics are discounted based on duplicate volume. To determine the discount for the multiple units, multiply the price for a quantity of one (above) by the following factors:

Quantity	Discount Factor
2-5	.97
6-10	.96
11-15	.95
16-25	.94
26-50	.93
Above 50	Call for quote



● Specifications

Shipping Weight
Unit with Graphic 8 lbs.
(add 2 - 5 lbs. for box
and packing)

Unit Heights
39" Collapsed
96" Fully Extended

Unit Colors
Black

Unit Specification
Will accommodate two
lights for a double-sided
graphic unit.

● Accessories

Light
50 watt halogen w/attachment clip;
available in black or silver...\$59 ea.

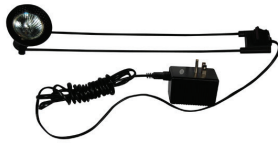

Carry Cases
40.5"h x 5 3/4"d Carrying Case.....\$25
48"h x 5 3/4"d Carrying Case.....\$35

Shipping Cases
"O" Case 39.5".....\$115

Light Bag
Black canvas w/ handles; holds 2
lights.....\$30 ea.



Literature Holders
5"\$26 ea.



RANGE™

The Range uses state-of-the-art edge magnet technology and a slide-lock hardware connection system to create a seamless graphic mural or backdrop by combining multiple Range units together. It can be single or double-sided, has adjustable mast and panel height and comes with a carrying case. The bottom of the graphic is fully adjustable. No tools required. The Range units can be purchased without a graphic. This product only allows for Lambda laminated graphics.



MADE IN U.S.A.

Range system 32" w x 78" h (x3) w/Lambda Bright & lights \$1,245

Pricing (includes graphic, unit and hardware)

Graphic Size	Range w/Lambda Bright
24" w x 30" h	\$211 each
32" w x 40" h	\$257 each
32" w x 78" h	\$356 each
39.5" w x 60" h	\$347 each
48" w x 96" h	\$541 each

- For graphic sizes & prices other than those listed above, please determine prices from appropriate price list.
- For Range units with double-sided graphics, add \$40 for hardware to the cost of the second graphic.
- Custom sized graphics are available, add \$10 per graphic to the hardware price above for custom hardware.
- A Mural of 3 panels creates a 9'10" mural which is ideal for a 10ft. space.

Units & Hardware can be purchased without graphic
Unit\$120

Discounts for Duplicate Murals Sets Only The price of the hardware unit is passed on to you at Optima's cost plus shipping and handling and is not discountable. The graphics are discounted based on duplicate volume. To determine the discount for the multiple units, multiply the price for a quantity of one (above) by the following factors:

Number of Murals	Discount Factor
2-5	.95
6-10	.92
16-25	.90
26-35	.88
36+	Call for quote

Specifications

Shipping Weight
Unit with Graphic 12 lbs. each
(add 2 - 5 lbs. for box and packing)

Unit Colors
Silver

Unit Heights
39" Collapsed
96" Fully Extended

Accessories

Light
50 watt halogen w/ attachment clip; available in black or silver...\$59 ea.

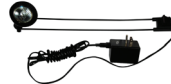

Light Bag
Black canvas w/ handles; holds 2 lights.....\$30 ea.



Shipping Cases

"O" Case
50.75"...\$120



"O" Case
39.5"...\$115



Carry Cases
40.5" h x
5 3/4" d...\$25
48" h x
5 3/4" d...\$35

RELAY™

The Relay uses edge magnet technology and a slide-lock connection at the top to create seamless murals by combining multiple units together. It can be single or double-sided, has an adjustable mast and panel height and comes with a carrying case for the hardware. Relay units can be purchased without a graphic. This product only allows for Lambda laminated graphics.



Relay backwall 31.5" w x 98" h (3) w/Lambda Bright & lights \$1,398

Pricing (includes graphic, unit and hardware)

Graphic Size	Lambda Bright
31.5" w x 78" h	\$356 each
31.5" w x 98" h	\$407 each
39.375" w x 60" h	\$347 each
47.25" w x 98" h	\$541 each

- For graphic sizes & prices other than those listed above, please determine prices from appropriate price list.
- For Relay units with double-sided graphics, add \$40 for hardware to the cost of the second graphic.
- Custom sized graphics are available, add \$10 per graphic to the hardware price above for custom hardware.
- A Mural of 3 panels creates a 9'10" mural which is ideal for a 10ft. space.

Units & Hardware can be purchased without graphic

Unit\$120

Discounts for Duplicate Murals Sets Only The price of the hardware unit is passed on to you at Optima's cost plus shipping and handling and is not discountable. The graphics are discounted based on duplicate volume. To determine the discount for the multiple units, multiply the price for a quantity of one (above) by the following factors:

Number of Murals	Discount Factor
2-5	.95
6-10	.92
16-25	.90
26-35	.88
36+	Call for quote

Specifications

Shipping Weight
Unit with Graphic 13 lbs. each
(add 2 - 5 lbs. for box and packing)

Unit Color
Silver

Unit Heights
40" Collapsed
98" Fully Extended

Accessories

Light
50 watt halogen w/ attachment clip; available in black or silver....\$59 ea.

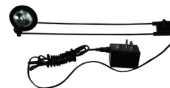

Light Bag
Black canvas w/ handles; holds 2 lights.....\$30 ea.



Shipping Cases

"O" Case
50.75" ...\$120

Carry Cases

40.5" h x
5 3/4" d...\$25

"O" Case
39.5" ...\$115
48" h x
5 3/4" d...\$35



The WALL™

The Wall fabric graphic system is specially designed for large, dye sublimation graphics. The structure is constructed to adjust from 48" to 144" wide and 36" to 144" high. Custom "Wall" units can be created greater than 144" in width. The Wall has an adjustable, heavy-duty, lightweight, aluminum alloy constructed frame with simple twist-together assembly. Strong horizontal and vertical extension poles ensure extra stability. Choose the best graphic for your customer from our two dye sublimation graphic options. The framework can be purchased without a graphic. The Wall can also be purchased with a compartmentalized soft carrying bag or hard case with wheels.

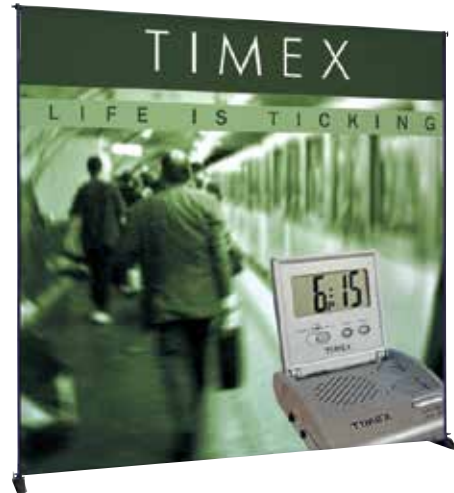

The Wall 120" w x 96" h (Type B) w/Kaleidoscope Select \$924

Pricing (includes graphic and unit)

Wall Type	Adjustable Width	Adjustable Height	Colossus 4 color or Kaleidoscope Select Polyknit
A (Standard Unit)	48" to 96"	36" to 96"	\$733 (96" x 96")
B	48" to 120"	36" to 96"	\$924 (120" x 96")
C	48" to 144"	36" to 96"	\$1,085 (144" x 96")
D	48" to 120"	36" to 120"	\$1,136 (120" x 120")
E	48" to 144"	36" to 144"	\$1,546 (144" x 144")

- Prices above based on Colossus 4 color or Kaleidoscope Select at \$8/sq.ft. For graphic size prices other than those listed above, please determine prices from appropriate price list.
- Please keep in mind seam requirements for each of these graphics.
- Custom "Walls" greater than 144" in width please call for a quote.
- It is recommended that any width past 144" not extend past 96" in height.

Units can be purchased without graphic

- A\$184
- B\$289
- C\$338
- D\$289
- E\$338

Specifications

Shipping Weight
Unit with Graphic 25 lbs.
(add 2 - 5 lbs. for box and packing)

Unit Color
Silver & Black

Standard Unit Weight
15 lbs.

Standard Graphic Weight
10 lbs.

Accessories

Shipping Cases
"O" Case
50.75".... \$120

Light
50 watt halogen w/clamp.....\$74 ea.
(available in black or silver)

Carry Bag
with compartments for frame only
Price ... \$45 each



Light Bag
Black canvas w/handles; holds 2 lights \$30 ea.





The most flexible, modular portable exhibition system. An exhibition stand that is different! Twist offers incredible flexibility, stability and ease of use. The Twist has been designed to fulfill a wide range of exhibiting solutions, from 10' spaces to endless backwalls.

The Twist gives you the ultimate in flexibility and value for your money. no tools necessary for kit assembly.



Chairs & Table Not Included

Pricing

Twist Display Kit Total Price \$2,156

Includes:

- 8ft Twist Display with Hardware
- Two 86.625" x 39.4" Lambda Bright flat graphic panels w/ hardware
- One 86.625" x 21.7" Lambda Bright Flexi Connector graphic panel w/hardware
- Two lights
- Small single hard shipping case

Connect 8ft Twist Display Kits by adding a Lambda Bright Flexi Connector graphic panel with connector magnet bar sets. Price \$400 each.

Single hard case
Lambda Graphic wrap **\$199**

Double hard case
Lambda Graphic wrap ... **\$236**



Case open Case closed w/Graphic Wrap

Two 8ft Twist kits w/Lambda Bright, 1 Flexi Connector panel & 2 single cases w/graphic \$5,232

Replacement Graphics & Hardware

86.625" x 39.4" Lambda Bright flat graphic panels w/hardware \$385 each

86.625" x 21.7" Lambda Bright Flexi Connector graphic panel w/hardware \$345 each



Create backdrops and exhibition displays that are unique. Center connection panel bends to create convex to concave displays.



Add a monitor to your Twist Kit for multi media activity. (Price of kit shown \$2,660 - monitor not included in price.)

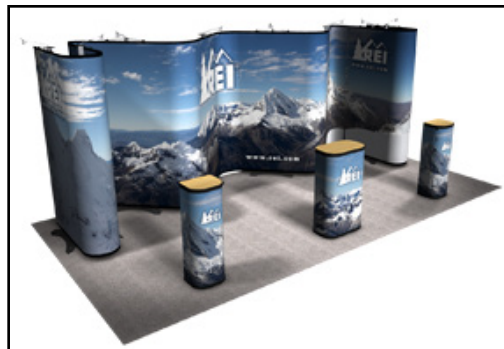

Four Twist Kits and Three Flexi Connector panels fill up a 10' x 20' display space. (Price of kit shown \$10,702)



Two Twist Kits and one additional Flexi Connector panel combine to form a corner display. (Price of kit shown \$5,070)

● Specifications

Shipping Weight
51 lbs.

Foot Color
Black

● Accessories

Shipping Cases

When ordering multiple kits you can combine cases or use multiple single case options.

Price \$195 each

(Graphics available for single and two case options.)

Media Bracket & Base (optional)

Price \$305 each

Single Case Hard top (optional)

Price \$61 each

Double Case Hard top (optional)

Price \$122 each



Single Hard Case
Size: 43”h x 16”w x 12”d

Two Hard Cases
Size: 43”h x 16”w x 16”d



Scene UltraLight

Maxibit Scene UltraLight is a fabric walling system for creating stunning backdrops fast. Scene UltraLight has a standard width of 118" wide and 92" high. It's a lightweight and versatile system that can be folded up anywhere in minutes. Scene UltraLight comes in three variations, curved, straight and a combination of curved and straight. You can create convex, concave, serpentine and straight designs or a combination of them all. The magnetic ends on the graphic poles give you the freedom to create and expand your message.



Pricing (includes graphic, unit & case)

Maxibit Scene UltraLight unit w/Colossus graphic & case \$1294

Available in curved and straight.

Maxibit Scene Ultralight Unit & case	\$620
Colossus Graphic	\$674
Total	\$1,294



Included shipping case



Pole Clip *



Aluminum Bases



Bungee Poles

* Pole clips will show on front of graphics top and bottom.



Maxibit Scene UltraLight Curved Option

Specifications

Shipping Weight
18lbs - in shipping case

Dimensions
Frame:
Open: 118" x 88.5"
Closed: Case size 38" x 12" x 5"

Graphic:
Print size 118"h x 91.25"h
Live area 118"w x 82.25"h
Final size 118"h x 86.25"h

Unit Color
Black

Accessories



Maxibit light - \$98 each

Big Banner Finishing

Single-Sided Banner – A banner with an image printed on only one side of the material.

Double-Sided Banner – A double-sided banner can be produced by printing two individual banners and sewing them back-to-back. An opaque layer is sewn between the two banners upon request for \$1 per sq. ft. additional.

Grommet – A round metal eyelet which can be used for fastening or hanging. Unless a grommet size is specified, the default size is a 3/8" grommet. A 1" hem perimeter for reinforcement is recommended.

Hem – An edge folded back and sewn. To prepare a side of the banner for a hem, it needs to be printed 1/2" bigger than the finished size. Example: A finished banner at 20"x 20" and hemmed on all four sides—should be printed 21" x 21".

Surged Edges – A finished stitch along the edges of a banner. If surged edges are sewn, a hem is not needed.

Silicone Edged Graphic system (SEG) - This finishing system uses a Poly Knit material that gets silicone welting sewn to the back perimeter edge of the fabric. This edge is then inserted into a groove on the perimeter of the frame to create a taught, flat display. SEG can be used on several types of extrusion systems like; AGAM, Duo, Classic Modul, Octonorm and Nouveau (see page G-29). SEG finishing is available for other extrusion systems not mentioned here. Please contact your customer service representative for details.

Pole-Pocket – An edge folded over a specified distance, sewn and used to hold a pole for hanging. At right is our recommended pocket size for various sized poles. A banner that requires a pole pocket will be printed with extra material in order for the edge to be folded over to make the pocket. When determining your live area, please take into consideration that a seam will appear on the banner where the pocket is sewn.

Pole Diameter	Pocket Size
1/2"	2"
1"	3"
1 1/2"	4"
2"	5"

Do not include your graphic live area in the extra printed material otherwise your text and/or images will be folded into the pole pocket. Therefore, please allow for adequate space based on the pocket size, otherwise your text, image and/or logo may have a seam through it.

Seam – If a banner is wider than our bolts of banner material, a sewn or taped seam will be necessary.

Opaque Blocker – For materials that are not opaque, an opaque blocker is recommended between double-sided banners to avoid seeing the images through the banners. It also may be applied to a single sided banner to block the light. Blocker is \$1 per sq. ft.

Finishing Issues To Keep In Mind

When a banner involves finishing, keep in mind:

- The location of the grommets
- Your live area in reference to the location of the stitching for your hem and/or pole pockets
 - Non duplicate minimum graphic size is 4 sq. ft.
 - All finishing options are included in square foot price, except opaque blocker.
 - For smaller banners please call for a quote.
 - For banners wider than the above "Print Maximum," there will be one or more seams.
 - Seams can run vertical or horizontal - please specify within the artwork.
 - Kaleidoscope and Colossus banners can be single or double-sided.
 - All materials can be ordered as fire retardant. Please allow 7-10 business days for materials that are not already fire retardant. Add \$.50 per sq. ft. for fire retardancy.
 - Banners are finished per your specifications with pole pockets, grommets and seams at no extra charge.
 - Maximum Kaleidoscope Select print width is 70". A sail tape, sewing, or combination will be utilized for wider banners.
 - Maximum Colossus print width is 118". A sail tape, sewing or combination will be utilized for wider banners.
 - Add \$15 per banner for wind slits.
 - Sq/ft price is based off of total material usage.



Big Banner finishing used in indoor and outdoor environments.



Our Team & Facility can handle your Big Banner requests.



Colossus graphics are 118" wide seamless dye sublimation fabric graphics. Colossus has brilliant color, is permanent, easy to clean and has superior resolution. You can order your graphics produced with 4 and 8 color process. Colossus is perfect for large fabric graphics or high volume orders of smaller graphics. Colossus is great for use on Truss and Extrusion Systems. 10' banners can be seamed to create monster-sized banners.

● Specifications

- An opaque blocker is recommended between doublesided banners.
- For duplicate images see discount schedule in "Terms & Conditions section page J-3".
- For 70" or smaller dye sub graphics, Kaleidoscope select is recommended.
- Sq/ft price is based off of total material usage.

● Pricing

Material	Surface Texture	Weight	Print Max	4 Color per sq. ft. Price	8 Color per sq. ft. Price
Poly Knit	Soft Matte	7.5 oz.	118"	\$ 8.00	\$ 9.00
Celtic Cloth	Soft Matte	5.1 oz.	118"	\$ 8.00	\$ 9.00
Weave	Semi Transparent Soft Matte	3.8 oz.	118"	\$ 8.00	\$ 9.00
Poly Duck	Matte / Canvas	6.1 oz.	118"	\$ 8.00	\$ 9.00
Polylucent	Sheer	1.8 oz.	118"	\$ 8.00	\$ 9.00
Gaming Suede	Felt	5.2 oz.	118"	\$ 8.00	\$ 9.00
MicroKnit	Soft Knit/Canvas	6.7 oz.	118"	\$ 8.00	\$ 9.00
TriFab	Soft Suede	7.5 oz.	116"	\$ 8.00	\$ 9.00
Lucent Plus	Sheer	1.2 oz.	118"	\$ 8.00	\$ 9.00
Satin Plus	Spun Satin	3.8 oz.	118"	\$ 8.00	\$ 9.00
Celtic Recycled Cloth (59% recycled content)	Soft Matte	5.0 oz.	118"	\$ 9.00	\$ 10.00
MicroKnit Recycled (55% recycled content)	Soft Knit/Canvas	6.6 oz.	118"	\$ 9.00	\$ 10.00
Silhouette	Smooth	7.6 oz.	118"	\$ 8.50	\$ 9.50
Brilliance	Soft Matte/Knit	8.3 oz.	118"	\$ 8.50	\$ 9.50
Opaque Blocker		5.5 oz.		Add \$ 1.00 per sq/ft	

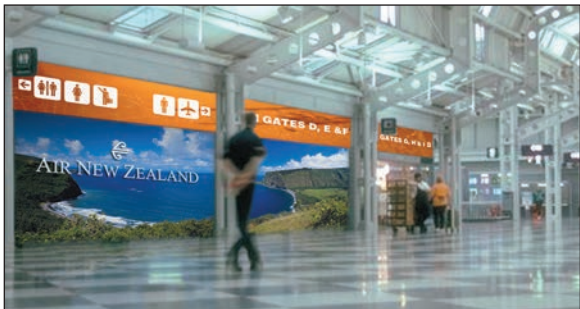



The Kaleidoscope Select process is our preferred fabric banner option! The exciting dye sublimation process involves using specific sublimation inks that once heat activated at 400 degrees, will “flash” into a gaseous state, penetrating and dyeing the fabric. The sublimation process is permanent because the image actually becomes part of the material. Dye sublimation fabric banners can be washed and ironed. Dye sublimation banners do not have any size limitations, but may require a seam.

● Specifications

- Non duplicate minimum graphic size is 4 sq. ft.
- Sq/ft price is based off of total material usage.
- For smaller banners please call for a quote.
- For banners wider than the “Print Maximum” there will be one or more seams.
- Seams can run vertical or horizontal - please specify within the artwork.
- Kaleidoscope Banners can be single or double-sided. Blocker is recommended for double sided graphics
- All materials can be ordered as Fire Retardant. Please allow 7-10 business days for materials that are not already fire retardant. Add \$.50 per sq. ft. for fire retardancy.
- For duplicate images see discount schedule in “Additional Information section page J-3”.

● Pricing

Material	Surface Texture	Weight	Print Max	Cost per Sq. Ft.
Poly Knit	Soft Knit	7.5 oz.	70”	\$ 8.00
Celtic Cloth	Soft Matte	5.0 oz.	70”	\$ 8.00
Poly Duck	Matte / Canvas	6.1 oz.	68”	\$ 8.00
Poly Poplin	Soft Matte / Canvas	5.5 oz.	58”	\$ 8.00
Poly Satin	Satin Shine	4.1 oz.	58”	\$ 8.00
Poly Silk	Woven Silk	2.1 oz.	58”	\$ 8.00
Dacron	Polished Canvas	3.9 oz.	58”	\$ 8.00
Sports Mesh	Polyester Eyelet	5.2 oz.	60”	\$ 8.00
Hercules	Heavy wt. Canvas	9.0 oz.	58”	\$ 8.50
Wrinkle Resist	Soft Poly Twill	6.5 oz.	62”	\$ 9.00
Gaming Suede	Soft Suede	7.6 oz.	70”	\$ 9.00
MicroKnit	Soft Knit / Canvas	6.7 oz.	70”	\$ 8.00
Weave	Semi Transparent / Soft matte	3.8 oz.	70”	\$ 8.00
Polylucent	Sheer	1.8 oz.	70”	\$ 8.00
TriFab	Soft Suede	7.5 oz.	70”	\$ 8.00
Lucent Plus	Sheer	1.8oz.	70”	\$ 8.00
Celtic Recycled Cloth (59% recycled content)	Soft Matte	5.1 oz.	70”	\$ 9.00
MicroKnit Recycled (55% recycled content)	Soft Knit/Canvas	6.6 oz.	70”	\$ 9.00
Silhouette	Smooth	7.6 oz.	70”	\$ 8.50
Pennant	Full Saturation / Bleed thru	2.5 oz.	58”	\$ 8.00
Brillance	Soft Matte / Knit	8.3 oz.	70”	\$ 8.50
Recycled Paradise (100% recycled content)	Matte	7.5 oz.	60”	\$ 10.00
Opaque Blocker		5.5 oz.		Add \$ 1.00 per sq/ft

Fabric Applications Chart

Fabric	Surface Texture	Output Process / Max Size	Product Application
Poly Knit	Soft Knit	Colossus / 118" x 540" Select / 70" x 300"	Burst, VBurst, The Wall, Fabrimural and Freestanding Extrusion Systems
Celtic Cloth	Soft Matte	Colossus / 118" x 540" Select / 70" x 300"	Tension Fabric Graphics, Pillow Casing, Hanging Signs and Truss Systems
Sports Mesh	Flexible Polyester Eyelet	Select / 60" x 300"	Primarily for the Alfresco / Outdoor banners
Wrinkle Resist	Soft Poly Twill	Select / 62" x 300"	Primarily for Table Throws
MicroKnit	Knit/Canvas	Colossus / 118" x 540" Select / 70" x 300"	Retractable and Non-Retractable Banner Stands
Diamond Finish	Soft Matte with opaque backer	Colossus / 50" x 540" Select / 50" x 300"	Primarily for Retractable Banner Stands when superior opacity is desired.
Gaming Suede	Soft Suede	Colossus / 118" x 540" Select / 70" x 300"	Burst, VBurst and Freestanding Extrusion Systems
Poly Duck	Matte/Canvas	Select / 68" x 300"	Retractable and Non-Retractable Banner Stands
Poly Poplin	Soft Matte/Canvas	Select / 58" x 300"	Retractable, Non-Retractable Banner Stands and Hanging Banners
Poly Satin	Satin Shine	Select / 58" x 300"	Non-Retractable Banner Stands and Hanging Banners
Poly Silk	Woven Silk	Select / 58" x 300"	Hanging Banners
Dacron	Polished Canvas	Select / 58" x 300"	Non-Retractable Banner Stands and Hanging Banners
Hercules	Heavy Weight Canvas	Select / 58" x 300"	Non-Retractable Banner Stands and Hanging Banners
Weave	Semi Transparent/ Soft Matte	Colossus / 118" x 540" Select / 70" x 300"	Pillow Casing and Hanging Banners
Polylucent	Sheer	Colossus / 118" x 540" Select / 70" x 300"	Hanging Banners and Freestanding Extrusion Systems
Lucent Plus	Sheer	Colossus / 118" x 540" Select / 70" x 300"	Hanging Banners and Freestanding Extrusion Systems
TriFab (Backlit)	Soft Suede	Colossus / 116" x 540" Select / 70" x 300"	Wall Units, Hanging Banners and Extrusion Systems
Satin Plus	Spun Satin	Colossus / 108" x 540"	Non-Retractable Banner Stands and Hanging Banners
Celtic Recycled Cloth	Soft Matte	Colossus / 118" x 540" Select / 70" x 300"	Tension Fabric Graphics, Pillow Casing, Hanging Signs and Truss Systems
MicroKnit Recycled	Knit/Canvas	Colossus / 118" x 540" Select / 70" x 300"	Retractable and Non-Retractable Banner Stands
Silhouette (Backlit)	Smooth	Colossus / 118" x 540" Select / 70" x 300"	Tension Fabric Graphics, Pillow Casing, Hanging Signs and Truss Systems
Pennant	Full Saturation / Bleed thru	Select 58" x 300"	Banshee systems and Hanging Banners

Fabric Applications Chart continued

Graphics-Graphic Processes
Dye Sublimation

Fabric	Surface Texture	Output Process / Max Size	Product Application
Brilliance	Soft Matte / Knit	Colossus / 118" x 540" Select / 70" x 300"	Burst, VBurst, The Wall, Fabrimural and Freestanding Extrusion Systems
Recycled Paradise	Matte	Select / 60" x 300"	Retractable and Non-Retractable Banner Stands

Silicone Edged Graphic system (SEG)

With SEG, fabric graphics are finished with a silicone welting sewn to the back perimeter edge of the fabric. Unlike round beaded finishing options SEG is a flat silicone welting. This edge is then inserted into a groove on the perimeter of the frame to create a taut, flat display. SEG can be used on several types of extrusion systems like; AGAM, Octonorm, Nouveau, Infinity and Classic Modul. SEG finishing is available for other extrusion systems not mentioned here. Please contact your customer service representative for details.



Silicone Edge Graphic close up.

Pricing

Kaleidoscope Select 4 color SEG fabric graphics	\$9.00 per sqft
Colossus 8 color SEG fabric graphic	\$9.00 per sqft

NOTE: A 1" bleed perimeter is recommended.
The sq/ft price is based off of total material usage.

For an easy way to determine graphic live area use this link: <http://tinyurl.com/ydo4n2o> to watch a helpful video on our YouTube page.

Maximum sizes and limitations for freestanding SEG frames

Double sided graphic – overall 20' wide x 8' tall
- Nouveau extrusion with supports Duo supplied feet/base plates – 14" Lateral (arched) feet on each end with 12" horizontal or circle feet distributed along the bottom.

- Agam FH452 extrusion with supports. Agam supplied feet/ base plates – 12" Lateral with 15" round base plates or all 23" oval base plates

- Octanorm M1307 extrusion with supports
Octanorm supplied 12.5" horizontal base plates

Single sided graphic – 30' wide x 118" tall
- Nouveau & Mercure extrusion with supports. Corner brackets will be doubled on vertical supports Agam supplied 23" oval base plates (no Duo circle feet) AND Nouveau 20"x8" return stabilizers on the back of at least two vertical support extrusion beams.

- Agam FH452 extrusion with supports. Agam supplied 23" oval base plates AND 20"x8" return stabilizers on the back of at least two vertical support extrusion beams.

- Octanorm M1307 extrusion with supports. Agam supplied 23" oval base plates AND Octanorm 20"x8" return stabilizers on the back of at least two vertical support extrusion beams.

***118" Exceptions, max frame height 120" on these fabrics only**
Brilliance (Heavy Celtic) – 124" fabric width - max print width 122"

Specifications

Extrusion frames carried in stock:

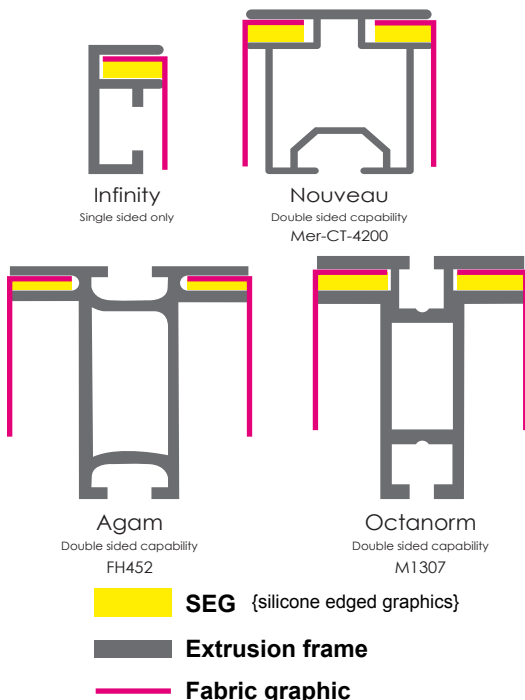

Note: Extrusion systems are everywhere, if you have an extrusion system that can accept SEG, Optima can create the graphics for it! If you do not see your extrusion system listed here contact your customer service representative.

Silicone Edged Graphic system (SEG)

Basic SEG Installation:

Your frame's installation steps may vary. It is important to insert graphics into each corner of frame then the sides. If this is not done your graphics will not fit correctly into the frame.

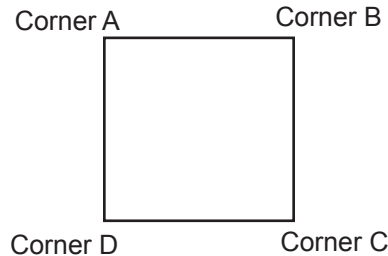

To remove the graphic from the frame locate the fabric pull tab. Gently pull up on the tab to remove the fabric.

Step 1

Start corner A, turn edge of graphic so silicone welt is perpendicular to face of graphic. Insert narrow side of welt (with fabric to outside) into the channel. Do the same for the other side of this corner.



Step 2

Follow step 1 for opposite corner C, then corner B, then corner D.



Step 3

Once all corners are inserted, start on one side pressing silicone edge into channel from outer corner working toward the center. Make sure welt is fully inserted into channel and smooth out edges of graphic.



Why Our Customers Love SEG Finished Fabric Graphics

- Tight as a drum, vivid, flat fabric graphics replace hard panel graphics in custom displays.
- Highest quality look is achieved.
- Combine with scrim fabric panels for the creative environments.
- Neatly finished corners.
- Works with the leading extrusion systems.
- More visible graphic, less frame.
- Pull tabs applied for easy material removal from frame.
- Quick install and even faster break down.
- Storage issues, drayage and shipping costs all improve with fabric graphics.
- Superior fabric used for best results with installation and image quality.
- Optima is the suggested fabric graphic vendor for the leading extrusion vendors!

IN STEP carpet graphics

In Step carpet graphics are perfect for any indoor event or trade show environment. Use them for full color exhibition flooring, mats, carpet tiles or runners to direct your audience and promote your product.



Pricing

Colossus 8 color Dye Sub Carpet	\$10.00 per sqft
Available Width	118" w
Material Construction	Polyester Felt with 8oz. rubber backing



In Step carpet is 1/8" thick. This includes polyester felt and rubber backing.



Benefits:

- Rubber backing reduces sliding
- Good abrasion resistance to foot traffic
- Vibrant color prints
- Full color Colossus dyesub

Note: InStep carpeting line up is image dependent

Due to the characteristics of InStep carpet graphics, some images can not be guaranteed for line up when piecing multiple graphics together. Maps, grids or detailed images that need line up may not match up completely in all areas.

Please work with your account representative to discuss your specific art before committing to an order with your client.

We are here to help with suggestions and address concerns to provide you the best results.

Print Process: Dye Sublimation
Available Widths: 118" max
Material Surface: 1/8" thick Polyester Felt
Backing Material: 8oz. rubber to reduce sliding.

Mural Pricing by Manufacturer

(Pricing based on Lambda Bright with HDL laminate)

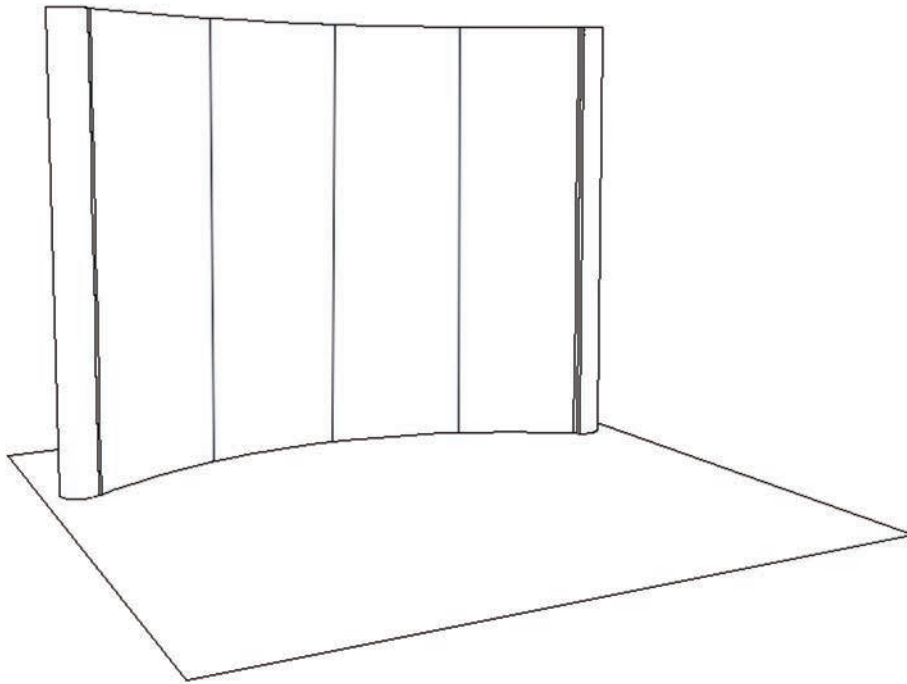

System	Panel Size	Panel Price	Endcap Size	Endcap Price
Optima SYNC	29.4375"w x 89.75"h	\$245 ea	15"w x 89.75"h	\$162 ea
Classic Quadro S	27.0625"w x 88.125"h	\$247 ea	22"w x 88.125"h	\$214 ea
Classic Quadro EO	29.4375"w x 89.75"h	\$271 ea	15"w x 89.75"h	\$162 ea
Nomadic Classic	29.4375"w x 89.75"h	\$271 ea	15"w x 89.75"h	\$162 ea
Abex Curved	29.625"w x 90.25"h	\$271 ea	15.75"w x 90.25"h	\$169 ea
Featherlite Curved	29.3125"w x 92.25"h	\$280 ea	17"w x 92.25"h	\$176 ea
Skyline	29.375"w x 89.25"h	\$271 ea	14.5"w x 89.25"h	\$152 ea

To price other systems get your base price from Lambda page GL-2.
Add \$20 to each front panel and \$15 to each end cap for hardware and magnets.

LAMBDA

LAMBDA BRIGHT - A Lambda Bright print is a long lasting, flexible, resin coated, paper based print that produces high quality continuous tone photos.

Size Sq. In.	HDL Laminate	Size Sq. In.	HDL Laminate	Size Sq. In.	HDL Laminate
0 - 100	\$21	2001 - 2100	\$206	4001 - 4100	\$373
101 - 200	\$30	2101 - 2200	\$213	4101 - 4200	\$381
201 - 300	\$40	2201 - 2300	\$219	4201 - 4300	\$389
301 - 400	\$47	2301 - 2400	\$227	4301 - 4400	\$397
401 - 500	\$65	2401 - 2500	\$236	4401 - 4500	\$405
501 - 600	\$74	2501 - 2600	\$244	4501 - 4600	\$413
601 - 700	\$85	2601 - 2700	\$251	4601 - 4700	\$421
701 - 800	\$91	2701 - 2800	\$260	4701 - 4800	\$429
801 - 900	\$101	2801 - 2900	\$269	4801 - 4900	\$437
901 - 1000	\$111	2901 - 3000	\$279	4901 - 5000	\$445
1001 - 1100	\$120	3001 - 3100	\$287	5001 - 5100	\$453
1101 - 1200	\$129	3101 - 3200	\$297	5101 - 5200	\$461
1201 - 1300	\$137	3201 - 3300	\$306	5201 - 5300	\$469
1301 - 1400	\$147	3301 - 3400	\$315	5301 - 5400	\$477
1401 - 1500	\$154	3401 - 3500	\$325	5401 - 5500	\$482
1501 - 1600	\$161	3501 - 3600	\$334	5501 - 5600	\$490
1601 - 1700	\$171	3601 - 3700	\$342	5601 - 5700	\$498
1701 - 1800	\$180	3701 - 3800	\$352	5701 - 5800	\$506
1801 - 1900	\$191	3801 - 3900	\$358	5801 - 5900	\$514
1901 - 2000	\$199	3901 - 4000	\$365	5901 - 6000	\$522

LAMBDA DURATRANS - A Duratrans print is a flexible, plastic based print material that produces high quality backlit photos.

Size Sq. In.	No Laminate	HDL Laminate	Size Sq. In.	No Laminate	HDL Laminate	Size Sq. In.	No Laminate	HDL Laminate
0 - 100	\$27	\$33	2001 - 2100	\$227	\$276	4001 - 4100	\$402	\$490
101 - 200	\$34	\$41	2101 - 2200	\$234	\$285	4101 - 4200	\$411	\$501
201 - 300	\$46	\$57	2201 - 2300	\$244	\$296	4201 - 4300	\$420	\$512
301 - 400	\$59	\$71	2301 - 2400	\$252	\$306	4301 - 4400	\$429	\$523
401 - 500	\$70	\$85	2401 - 2500	\$262	\$320	4401 - 4500	\$438	\$534
501 - 600	\$84	\$102	2501 - 2600	\$272	\$331	4501 - 4600	\$447	\$545
601 - 700	\$94	\$115	2601 - 2700	\$281	\$342	4601 - 4700	\$456	\$556
701 - 800	\$105	\$128	2701 - 2800	\$291	\$354	4701 - 4800	\$465	\$567
801 - 900	\$116	\$141	2801 - 2900	\$304	\$372	4801 - 4900	\$474	\$578
901 - 1000	\$127	\$155	2901 - 3000	\$309	\$376	4901 - 5000	\$483	\$589
1001 - 1100	\$134	\$164	3001 - 3100	\$318	\$387	5001 - 5100	\$492	\$600
1101 - 1200	\$143	\$174	3101 - 3200	\$325	\$396	5101 - 5200	\$501	\$611
1201 - 1300	\$155	\$188	3201 - 3300	\$334	\$407	5201 - 5300	\$510	\$622
1301 - 1400	\$164	\$200	3301 - 3400	\$343	\$418	5301 - 5400	\$520	\$633
1401 - 1500	\$173	\$210	3401 - 3500	\$351	\$428	5401 - 5500	\$528	\$644
1501 - 1600	\$182	\$222	3501 - 3600	\$359	\$438	5501 - 5600	\$537	\$655
1601 - 1700	\$191	\$232	3601 - 3700	\$368	\$447	5601 - 5700	\$546	\$666
1701 - 1800	\$199	\$243	3701 - 3800	\$376	\$459	5701 - 5800	\$555	\$677
1801 - 1900	\$209	\$254	3801 - 3900	\$385	\$468	5801 - 5900	\$564	\$688
1901 - 2000	\$216	\$263	3901 - 4000	\$394	\$479	5901 - 6000	\$573	\$699

Lambda Floor Graphics Duraflex with Satin finish and floor grip glue on the back. *Graphics can be cut to shape.*
Price..... \$11/sf

LAMBDA

LAMBDA DURAFLEX & LAMBDA METALLIC - Lambda Duraflex print is a flexible, plastic based print material that produces high quality, continuous tone photos. A Lambda Metallic print is a flexible, rosin coated, paper based print which adds a pearlescent shine and color saturation to the graphic image. We recommend HDL Matte HDL Gloss laminate for Lambda Metallic prints.

Size Sq. In.	HDL Laminate	Size Sq. In.	HDL Laminate	Size Sq. In.	HDL Laminate
0 - 100	\$28	2001 - 2100	\$232	4001 - 4100	\$414
101 - 200	\$35	2101 - 2200	\$241	4101 - 4200	\$425
201 - 300	\$48	2201 - 2300	\$250	4201 - 4300	\$436
301 - 400	\$60	2301 - 2400	\$258	4301 - 4400	\$447
401 - 500	\$71	2401 - 2500	\$269	4401 - 4500	\$458
501 - 600	\$86	2501 - 2600	\$279	4501 - 4600	\$469
601 - 700	\$97	2601 - 2700	\$288	4601 - 4700	\$480
701 - 800	\$108	2701 - 2800	\$298	4701 - 4800	\$491
801 - 900	\$119	2801 - 2900	\$307	4801 - 4900	\$502
901 - 1000	\$130	2901 - 3000	\$317	4901 - 5000	\$513
1001 - 1100	\$138	3001 - 3100	\$325	5001 - 5100	\$524
1101 - 1200	\$147	3101 - 3200	\$334	5101 - 5200	\$535
1201 - 1300	\$158	3201 - 3300	\$343	5201 - 5300	\$546
1301 - 1400	\$168	3301 - 3400	\$351	5301 - 5400	\$557
1401 - 1500	\$178	3401 - 3500	\$360	5401 - 5500	\$568
1501 - 1600	\$187	3501 - 3600	\$369	5501 - 5600	\$579
1601 - 1700	\$196	3601 - 3700	\$377	5601 - 5700	\$590
1701 - 1800	\$204	3701 - 3800	\$386	5701 - 5800	\$601
1801 - 1900	\$214	3801 - 3900	\$395	5801 - 5900	\$612
1901 - 2000	\$222	3901 - 4000	\$403	5901 - 6000	\$623

LAMBDA

Lambda photo prints are the highest quality trade show graphics available. A Lambda print is produced by digital laser exposure to photographic film. Print options for Lambda include Lambda Bright, Lambda Duratrans, Lambda Duraflex and Lambda Metallic.

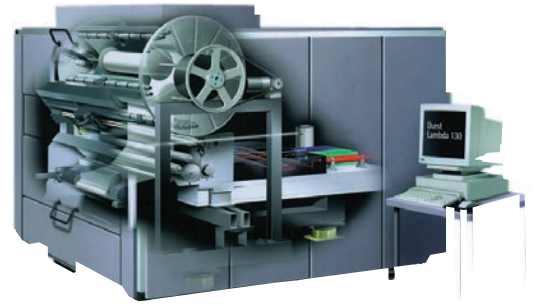

● Specifications

- 1) Lambda prints are available with the following laminates:
 - HDL Satin - Durable thermal laminate sandwich; satin surface finish and a clear gloss backing with a lifetime guarantee against de-lamination.
 - HDL Matte - Durable thermal laminate sandwich; matte surface finish and a clear gloss backing with a lifetime guarantee against de-lamination.
 - HDL Gloss - Durable thermal laminate sandwich; a clear gloss surface finish and a clear gloss backing with a lifetime guarantee against de-lamination.
 - HDL Black - Durable thermal laminate sandwich; satin or matte surface finish and a black opaque rear laminate with a lifetime guarantee against de-lamination.
Please add \$1 per sq. foot for black opaque backing.
- 2) For Lambda graphics mounted to rigid substrates: Multiply the square inch base price by 1.3 if the graphic is mounted to 1/8" - and by 1.4 if graphic is mounted to 1/4" Plexi, Gatorfoam or Sintra. For thicker substrates, please call for a quote. Multiply the base price by 1.15 if you supply the substrate. Add \$35 for Optima to remove a supplied substrate from a supplied frame in order to apply a graphic image to the substrate. For different thickness, please call for a quote.
Any print that is 30" x 30" or larger and mounted to a rigid substrate (i.e. Plexi, Sintra or Gatorfoam) will have to be shipped in a wooden crate or one way shipper. Cost of crate will be determined by size and quantity of graphics. The minimum charge for a one way shipper is \$120. See Cases and Crates section.
- 3) Lambda prints have velcro or magnets applied to the backside per your specifications.
- 4) Maximum size for Lambda prints is 48 inches by 15 feet.
- 5) No additional charge for: artwork that is print ready, RIP's, placement of graphic photo elements, file review, archiving artwork, or Lambda color matching.
- 6) Optional Processing:
 - Add \$60 for scanning images.
 - Add \$20 per panel for hanger bars, stiffeners and magnets. Add \$15 for end cap hardware.
 - Add \$1 per square foot for HDL black backing.
 - Add \$7.50 per graphic if drill holes are required.
 - For profile cutting (lamination is not guaranteed on profile cut images):
 - The typical charge is \$25
 - Add \$7.50 per cut for cutting panels into strips
 - Add \$7.50 per panel for radius corners
 - Please call for a quote on special cuts
- 7) Lambda graphic mural panels, by nature, are susceptible to scuffs and scratches if not properly handled. Storing and rolling graphic mural and graphic end cap panels in supplied bags will keep them looking new! It is imperative that supplied plastic protection bags be used each and every time the graphic is rolled and placed into a case. Failure to use the supplied plastic protection bag will result in graphic damage.

Dry Erase Laminate

Dry Erase Laminate is a clear 2mil pressure sensitive laminate that gives the ability to add a dry erase board feature to Print-on-it or Lambda graphics.

To make your next indoor substrate or laminate display interactive use the Dry Erase Laminate feature.



18" x 24" Dry Erase Laminate applied to Print-on-it sintra close up view

Pricing

Clear Dry Erase Laminate Add \$1.00 sqft to Lambda and Print-on-it pricing .

Specifications

Product Opacity
Clear

Available Widths
51" max

Material Surface Options
Glossy

Adhesive Material
Pressure sensitive overlam for dry erase applications

Use Dry Erase Laminate on the following applications:

Print-on-it

Sintra

PETG

Styrene

Ultraboard

Coroplast

12oz Saturn vinyl

Reposition-it

Controltac Positional Vinyl

Lambda

Bright

Duraflex

Duratrans

Solv-it!

Solvent Printing Process

What is Solv-it! printing?

Solv-it! solvent printing is a process that utilizes outdoor ink. Solv-it! banners are perfect for indoor or outdoor use. Featuring 12 months plus outdoor use with zero to minimal fading, Solv-it! is the best solution for great quality large outdoor banners and monster sized banners.

Pricing

Solv-it! 9oz. Solv-it! Mesh

A 9oz. single-sided vinyl banner material primarily for outdoor use but also great for unique styled indoor applications.

Single Sided	Price per square foot	
	4 color	8 color
Total square feet ordered		
50 - 75	\$6.50	\$7.50
76 - 100	\$6.00	\$7.00
101 - 150	\$5.50	\$6.50
151 +	Call for quote	

Solv-it! 15oz. Backlit Vinyl

A 15oz. coated backlit vinyl banner material for outdoor use but also great for indoor applications.

Single Sided	Price per square foot	
	4 color	8 color
Total square feet ordered		
50 - 75	\$7.00	\$8.00
76 - 100	\$6.50	\$7.50
101 - 150	\$6.00	\$7.00
151 +	Call for quote	

Solv-it! 13oz.

A 13oz. single-sided vinyl banner material primarily for outdoor use but also great for indoor applications.

Single Sided	Price per square foot	
	4 color	8 color
Total square feet ordered		
50 - 75	\$6.00	\$7.00
76 - 100	\$5.50	\$6.50
101 - 150	\$5.00	\$6.00
151 +	Call for quote	

Solv-it! 13 oz. Blockout Vinyl (indoor)

A 13oz. double-sided vinyl banner material primarily for indoor use. Great for unique styled indoor applications.

Single Sided	Price per square foot	
	4 color	8 color
Total square feet ordered		
50 - 75	\$6.00	\$7.00
76 - 100	\$5.50	\$6.50
101 - 150	\$5.00	\$6.00
151 +	Call for quote	

Solv-it! 15 oz. Blockout Vinyl

A 15oz. double-sided vinyl banner material primarily for outdoor use but also great for unique styled indoor applications.

Single Sided	Price per square foot	
	4 color	8 color
Total square feet ordered		
50 - 75	\$6.25	\$7.25
76 - 100	\$5.75	\$6.75
101 - 150	\$5.25	\$6.25
151 +	Call for quote	

Double Sided	Price per square foot	
	4 color	8 color
Total square feet ordered		
50 - 75	\$10.50	\$13.25
76 - 100	\$10.00	\$12.75
101 - 150	\$9.50	\$12.25
151 +	Call for quote	

Double Sided	Price per square foot	
	4 color	8 color
Total square feet ordered		
50 - 75	\$11.00	\$13.00
76 - 100	\$10.00	\$12.00
101 - 150	\$9.00	\$11.00
151 +	Call for quote	

Solv-it!™

Solvent Printing Process



Solv-it graphics applied to various outside structures.

Specifications

Solv-it! 9oz.

Print size: Any size composed from 10ft. sections. Individual pieces 120" max width by fall*

Surface texture: Matte

Opacity Level: N/A

Finishing options: Standard edges, pockets and grommet options combined with welding and sewn reinforcements.

Solv-it! 13oz.

Print size: Any size composed from 10ft. sections. Individual pieces 120" max width by fall*

Surface texture: Gloss

Opacity Level: Good

Finishing options: Standard edges, pockets and grommet options combined with welding and sewn reinforcements.

Solv-it! 13oz. Blockout Vinyl (indoor)

Print size: Any size composed from 10ft. sections. Individual pieces 120" max width by fall*

Surface texture: Matte

Opacity Level: Opaque

Finishing options: Standard edges, pockets and grommet options combined with welding and sewn reinforcements.

Solv-it! 15 oz. Blockout Vinyl

Print size: Any size composed from 10ft. sections. Individual pieces 120" max width by fall*

Surface texture: Matte

Opacity Level: Great

Finishing Options: Standard edges, pockets and grommet options combined with welding and sewn reinforcements.

Solv-it! 15oz. Backlit Vinyl

Print size: Any size composed from 10ft. sections. Individual pieces 120" max width by fall*

Surface texture: Matte

Opacity Level: Translucent

Finishing Options: Standard edges, pockets and grommet options combined with welding and sewn reinforcements.

*Due to digital imaging size limitations 8 color Colossus digital files over 30k sq. inches will require a seam.



Solv- it! Window Perf is ideal for exterior-mount window graphics. The print area of 65/35 means you get 65% of your image retained with only 35% perforation. This is much better than the 50/50 print area most window perforation graphics offer. Solv-it! Window Perf has a gloss surface and displays text and small details to help catch your audience's eye at your next event.

● Pricing

Solv-it! 8 color Print \$8.00/sqft

NOTE: Not intended to be used for vehicle windows.

● Specifications

Print Process
Solv-it! 8 color

Available Widths
54" max

Material Surface
Gloss

Perf Specifications
35% Perforated 65% Retained



Solv-it! Window Perf used in a retail display window.

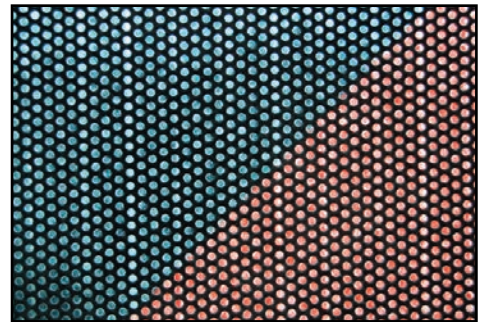

Window Perf perforation close up view



premium retractable graphic alternative

Mesa is the premium alternative to laminated retractable graphics. It is specially designed to minimize curling often associated with laminated retractable banner stand options.



Pricing

MESA Print \$8.50/sqft

**Pronto 33.25" w x 95" h
w/MESA graphic \$248**

Example of pricing comparison: (Pronto Unit)

Unit Size	Visual Live Area	Graphic Print Size	Lambda Bright	Kaleidoscope Select	Kaleidoscope Select w/ Diamond finish	Lambda Duraflex or Metallic	MESA
33.5" w	33.25" w X 86.25" h	33.25" w X 95" h	\$250	\$236	\$257	\$312	\$248

Product Highlites

- 99% Opacity
- Vibrant color
- Clean Matte finish
- Extremely durable
- Non Laminated high-quality graphic
- Only available for retractable banner stands
- Great alternative when laminated look is desired
- Minimizes curling associated with laminated graphics in banner stands.



The print-on-it process gives you the ability to print on sintra, outdoor banner material and positionable vinyl to name a few of the substrate options. This process uses the technology of UV direct printing to different substrates.

With the print-on-it process of printing graphics straight to substrates your imagination is your only limitation. A Plastic Profile that can be applied to substrate edges to get a clean finished look called FineEdge is available see pg. L4

NOTE: Due to potential damage of our equipment the Print-On-It process is only available on approved substrates. Call for details on your specific substrate.

Substrate	Color	Price	Description & Details
.020 Styrene	White	\$5.75 sq/ft	<p>Styrene is one of our most economical substrates. It's great for form fitting graphics onto curved areas, and great for use with displays that use channel systems. Other colors available for special order. Call for a quote.</p> <p>Print Max: .020 styrene - Max size: 60" w X Any Length / .030, .040 & .060 styrene - Max size: 4' x 8'</p>
	Black	\$7.25 sq/ft	
.030 Styrene	White	\$6.10 sq/ft	
	Black	\$7.60 sq/ft	
.040 Styrene	White	\$6.40 sq/ft	
	Black	\$7.90 sq/ft	
.060 Styrene	White	\$7.20 sq/ft	
	Black	\$8.70 sq/ft	
1/8 " Sintra	White	\$7.80 sq/ft	<p>Sintra is a durable substrate and comes in a range of thicknesses to choose from. This substrate is the best choice for permanent use and long term displays. Other colors available for special order. Call for a quote. Print Max: 5' X 10'</p>
	Black	\$9.30 sq/ft	
1/4" Sintra	White	\$8.60 sq/ft	
	Black	\$10.10 sq/ft	
1/2" Sintra	White	\$10.80 sq/ft	
	Black	\$12.30 sq/ft	
3/16" & 1/2" Ultraboard	White	\$8.40 sq/ft	<p>UltraBoard is a great choice for lightweight presentation graphics. Attaching an easel back for stability is great for short term use. UltraBoard is very durable and accepts ink better, than comparable lightweight substrates, resulting in a much deeper image. <i>Special order colors consist of red, blue, black surface with white center fill and white surface with black center fill. It is recommended that this substrate only be used in dry indoor environments.</i> Print Max: 5' X 10'</p>
	Black	\$9.90 sq/ft	
4mm Coroplast	White	\$5.40 sq/ft	<p>Coroplast is the best substrate for short term outside use. This substrate design accepts your metal yard stakes for displaying yard signs like real estate signs, use at golf outings, directional signs and many other outdoor event needs.</p> <p><i>NOTE: Not recommended for full bleed graphics. A 1/2" non print border is strongly recommended for ideal quality and durability. Metal yard stakes are available when using outdoors at a price of \$9.50 ea.</i> Print Max: 4' X 8'</p>
	Black	\$6.90 sq/ft	
12oz. Vinyl	White	\$7.50 sq/ft	<p>12oz. Vinyl material is the best choice for outdoor use. The vinyl material is great for grand opening, sides of buildings, announcing special community events and much more. Any situation that you have used a vinyl banner for in the past can be achieved with the 12oz. Vinyl, and an image from our print-on-it process. This material has a six month guarantee not to fade under normal circumstances. Print Max: 70" w X by any length</p>
Controllac Positionable Vinyl & Decals	White	\$7.50 sq/ft <i>Add \$1.75/sqft for cotrollac laminate*</i>	<p>Controllac Positionable Vinyl is designed for use on projects where you need to apply your image to contoured surfaces. If needed this material can be repositioned or adjusted to achieve the best display of your graphics. Once your graphic is in position just squeegee it into place for long term display.</p> <p>*Controllac Laminate is a clear 2mil semi-gloss laminate that can be applied to controllac vinyl. This protects and makes controllac easier to be removed.</p> <p><i>NOTE: Print-on-it graphics with controllac positionable vinyl are not recommended for vehicle wraps or other applications where the material is stretched to conform to a shape.</i> Print Max: 54" w X by any length</p>

Substrate	Color	Price	Product Description
Di-Bond	White Brushed Silver	\$15.00sq/ft \$18.00sq/ft*	Di-Bond 3mm opaque durable rigid substrate consisting of two .012" aluminum face with a polyethylene core. *Optional - Add \$1.50/sqft for white ink. Print Max: 4' X 8'
Reposition-it	White Clear (With and without white flood ink.)	\$6.95sq/ft \$6.95sq/ft	Reposition-it graphics are designed for short term use. It can be used on multiple surfaces such as; glass or other glossy surfaces, plastic, fully cured high gloss paint and other graphic materials. The cleaner the surface the better it will stick. Reposition-it can be profile cut and is easily removed and re-applied during application and has some reusable characteristics. Print Max: 54" / 6mil vinyl
Direct Print Floor Graphics	White	\$9.00sq/ft	UV direct print to low tac vinyl graphics with satin finish. Graphics can be cut to shape. Print Max: 51"
StreeTag	White Matte	\$8.50sq/ft	StreeTags are stickers/decals designed to adhere to asphalt, sidewalks, concrete and other outdoor surfaces. StreeTags are printed on a special material that easily adheres to most types of outdoor surfaces - horizontal and vertical alike. Print Max 54" / 4mil vinyl film
1/8" PETG	Clear	\$10.00sq/ft	<p>PETG is a high-impact, co-polyester material. It is more durable than other clear substrates. PETG is FDA compliant, so it can be used in medical and food applications. It stands up to radiation and chemical sterilization techniques without changing color. PETG accepts the ink far better than other acrylic substrates providing the highest quality print with the longest life cycle. This substrate is a great choice when clear substrate is required.</p> <p><i>NOTE: Plexi Acrylic substrates are not compatible with UV Direct print. PETG Acrylic Substrate is the superior choice for the UV printing process. Print Max: 4' X 8'</i></p>
1/4" PETG	Clear Frosted	\$11.50sq/ft \$12.00sq/ft	
1/8" & 1/4" Greenboard	1/8" White 1/4" White	\$8.10sq/ft \$8.90sq/ft	Greenboard™ Eco-Friendly Rigid Substrate is a premium quality, ultra-smooth rigid hardboard. The surface provides a firm base to support and enhance digital print images while ensuring image consistency. • Green substrate alternative • Bright white smooth printable surface • Recycled white foam PVC • 70% post consumer recycled content Print Max: 4' X 8'
Print-on-it 80" Backlit	White / Milky	\$12.00sq/ft	Print-on-it 80" Backlit is a 9mil backlit film with a gloss surface. It is great for indoor use and ideal for use in a lightbox and anywhere a graphic wider than 48" is required. Print Max: 80" w X by any length
Azuna 3D	Clear	\$8.50sq/ft	Azuna 3D is a pebble textured translucent material that accepts UV direct print. With a balance of imagery and unprinted space a great three dimensional look is achieved. Print Max: 38" X 55"
Custom Cuts	<p>Custom Cuts is any non-rectangular rigid print-on-it graphic. • \$20 cut charge for first shape then \$1 charge each duplicate shape on same job. • \$20 charge each additional different shape on the same job. <i>Complex custom cut files require a cut path. If no cut file is provided Optima will offer a quote to create one. Tech Support will identify any images that require this service.</i></p>		
Wincos	Clear	\$8.50sq/ft	Wincos is a 2mil optically clear low tack adhesive vinyl for use on windows only. Print Max: 58"
Clear Window Cling	Clear	\$6.95sq/ft	Clear Window Cling is clear static cling vinyl for use where you need to apply a window cling graphic. Print Max: 54"
Supplied Substrates	White Black or other colors	\$7.10 sq/ft \$8.60 sq/ft	Optima can print on many different substrates. Please contact your account rep for details. <i>NOTE: Your supplied substrate material will be required for testing prior to job approval.</i>

- The maximum media thickness is 1.75". • Add \$7.50 per graphic if drill holes are required.
- For two sided prints, determine the price for the first side per above prices then multiply that price by .75 and add the two prices together. • Minimum price for a graphic is the price of one square foot of that graphic. • All substrates up to 1/2" are in stock. If you need a substrate with a thickness over 1/2" please call.
- 12oz. Vinyl pricing includes finishing. (pole pockets, grommets, sewn in rope etc.)
- All materials shown in table are carried in stock. For all other materials please call for quote.
- Custom projects will be considered and evaluated for quality and expectations.

Discount Schedule for Duplicates

Qty	Discount
2 – 3	.95
4 – 6	.93
7 – 10	.91
> 10	Call for quote

REposition-it™ graphic coverings

Reposition- it can be used on multiple surfaces such as; glass or other glossy surfaces, plastic, paint and other graphic materials. The smoother and cleaner the surface the longer your image will stay flat and in position.

Reposition-it can be easily removed and re-applied during installation.

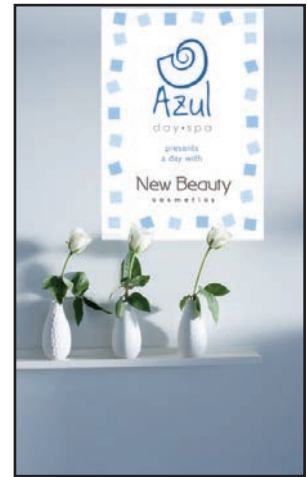

Reposition-it graphic applied to a wall

Pricing

UV Direct Print \$6.95/sqft

NOTE: the cleaner and smoother the surface, the better your graphic will adhere.

Specifications

Print Process

UV direct print to material

Available Widths

54" max

Material Surface Options

White and Clear

Adhesive Material

Pressure sensitive with premium removability



Streetags are temporary stickers/decals designed to adhere to asphalt, sidewalks, concrete and other outdoor surfaces. Use Streetags on vertical surfaces also like concrete columns. Streetags are printed on a special material that easily adheres to most types of outdoor surfaces - horizontal and vertical alike.

● Pricing

UV Direct Print \$8.50/sqft

NOTE: the cleaner and smoother the surface, the better your graphic will adhere.



Streetag graphics profile cut applied to a sidewalk

● Specifications

Print Process

UV direct print to material

Available Widths

54" max

Material Surface

White matte

Adhesive Material

Pressure sensitive 4mil vinyl film with adhesive back.



Community Event Streetag usage



Directional Streetag usage



uVision-it certified wall coverings enhance any environment.

Three popular texture styles:

- Mystical** - has a fine sand texture with a smooth feel.
- Suede** - has a rough pitted texture with a moderately flat touch.
- Mongahello** - has a rough stucco designed texture with hills and valleys.

All three styles yield state of the art image quality, make the most of the digital imaging process combining color, light, shape and shadow to bring your walls alive beyond expectations.

NOTE: Contact the installer of your choice before ordering.

Pricing

Wall Paper image size	Cost per sq/ft.
0 - 200 ft ²	\$8.00
201 - 400 ft ²	\$7.00
401 - 600 ft ²	\$6.00
601 - 800 ft ²	\$5.50
801 + ft ²	\$5.00

Preferred choice of facilities managers, architects, design engineers and interior decorators, uvision-it meets the needs of large spaces and high volume applications.

52" super wide by monster heights, meets or exceeds Federal Specification: CCC-W-408A & CFFW-W-101-D includes Early Warning Effect® fire detection for life and property protection.



Specifications

- Contact the installer of your choice before ordering. This will help assure you will have the most accurate information needed to order and produce your wall covering to determine roll width preference and any other pertinent installation specific details. Check your local Yellow Pages for professional "Paperhangers".
- Maximum width is 52" wide for a single piece by 20' high. Call for taller heights, borders or other horizontal applications. When ordering please specify the desired width and length of each strip.
- Our material is over printed by 1" for overlap cuts to help the installation process.
- Before cutting, examine to make certain color is satisfactory and as ordered. Install wall covering on a prepared surface, go to www.Visproducts.com and click on templates for instructions. Be sure to use adequate lighting and temperature conditions that will exist when the space is occupied.
- Please refer to the graphic specification page for scanning, design, color, hardware and miscellaneous service charges.

uVision-it is the answer for:

Corporate Interiors including; Lobbies, Conference Rooms, Training Rooms, Cafeterias and Showrooms. Plus...Retail Interiors, Restaurants, Airports, Hospitals, Office Buildings, Museums, Banquet Centers, Casinos, Assisted Living Centers, Community Centers, Automotive Dealerships, Anywhere...

You vision it and uVision-it image wall coverings meets the demand.

Duplicate discount for same image with same individually sized sections:

Quantity	Discount Factor
2	.955
3	.93
4	.9175
5	.90
6 - 8	.88
9 -14	.885
15 - 20	.82
20+	call for quote

Individual Lettering & Logos

Individual vinyl lettering and logos with pressure sensitive adhesive backing. The lettering and logos can be applied first & second surface to laminate panels, smooth substrates or 13 oz. vinyl banners.

Pricing

Vinyl Lettering and Logos

- \$13 per square foot (2 vinyl colors included)
- Add \$20 for each additional opaque color.
- Add \$40 for each additional translucent color.
- Maximum vinyl logo size is 46" w x 15' h.
- The lettering and logos are ready to apply – pricing includes weeding and application of transfer tape.



Vinyl lettering applied to a smooth substrate surface.

Vinyl Graphics on Substrates

Vinyl graphics can be applied first & second surface to rigid substrates.

The following are the most commonly used rigid substrates to apply vinyl graphics to:

Ultraboard - "Sandwich" board with foam center and a semi-hard veneer surface. The foam center is a high density Styrofoam and the surfaces are a resin-infused paper. Maximum sheet size is 4' x 8' with a thickness from 1/8" up to 1.5". Please check for availability of colors and thicknesses.

Sintra - Plastic sheet of expanded rigid PVC foam. Maximum sheet size is 4' x 8' with a thickness from 1/16" up. Please check for availability of colors.

Plexiglass, plastic & acrylic - All plastic sheet of acrylic. Sheet size is typically 4' x 8'. Thickness varies from 1/16" up. Please check for availability of colors.

Pricing

- Pricing is based on a substrate thickness of 1/8". For thicker substrate, please call for a quote. Price includes one opaque or one translucent vinyl color applied to plexi or substrate.
- Additional vinyl color pricing is as follows:
 - \$20 for each additional opaque vinyl color.
 - \$40 for each additional translucent vinyl color.

Size Sq. In.	2nd surface vinyl applied to clear plexiglass	1st surface vinyl applied to substrate
0 - 100	\$21	\$13
101 - 200	\$42	\$25
201 - 300	\$52	\$31
301 - 400	\$68	\$41
401 - 500	\$84	\$50
501 - 600	\$99	\$60
601 - 700	\$115	\$69
701 - 800	\$131	\$78
801 - 900	\$143	\$86
901 - 1000	\$157	\$94
1001 - 1100	\$170	\$102
1101 - 1200	\$183	\$110
1201 - 1300	\$191	\$115
1301 - 1400	\$198	\$118
1401 - 1500	\$204	\$122

Size Sq. In.	2nd surface vinyl applied to clear plexiglass	1st surface vinyl applied to substrate
1501 - 1600	\$210	\$126
1601 - 1700	\$216	\$130
1701 - 1800	\$223	\$134
1801 - 1900	\$228	\$137
1901 - 2000	\$235	\$141
2001 - 2100	\$241	\$145
2101 - 2200	\$248	\$148
2201 - 2300	\$254	\$153
2301 - 2400	\$260	\$156
2401 - 2500	\$266	\$160

Specifications

- Rigid graphics (except for supplied headers) have velcro or magnets applied to the backside per your specifications.
- Opaque vinyl backgrounds are produced with two layers of vinyl on clear substrates. The first layer is the specified vinyl color. This is backed with a second opaque vinyl to make the background fully opaque and avoid visible mottling. Mottling is when spots or blotches of different shades of color are seen. Without the opaque vinyl, most vinyl will show mottling **FIRST & SECOND SURFACE GRAPHICS**
- Most rigid surface substrates come in a maximum size of 48" x 96". Please call if graphic exceeds these dimensions.
- For a thickness other than our standard 1/8", please call for color options and a quote.
- When shipping a supplied plexi header with frame, please order frame from the manufacturer with plexi separate from the frame. If supplied header comes attached to the frame, add \$35 for Optima to remove the supplied substrate from a supplied frame in order to apply a graphic image to the substrate.
- Any Traditional graphic that is 30" x 30" or larger and mounted to a hard substrate (i.e. Plexi, Sintra or Ultraboard) will have to be shipped in a wooden crate. Cost of crate will be determined by the size and quantity of graphic. 1

QuickDrop™

Trade shows do not get any easier than this. Travel to and from your next trade show with a single 13" x 19" - 6lb bag. Designed to attach directly to an exhibit supplied pipe and drape system QuickDrop™ is simply the fastest most convenient solution.

Either by using the supplied ball bungees and hooks or by utilizing the top pole on any pipe and drape structure QuickDrop™ is simple convenient, economical and a super traveler. As fast as the QuickDrop™ is put up it can be taken down, folded up and your off to meet the next opportunity or catch an early flight.

If you need a graphic up fast at your next indoor event or show get the QuickDrop™ and get right to business.

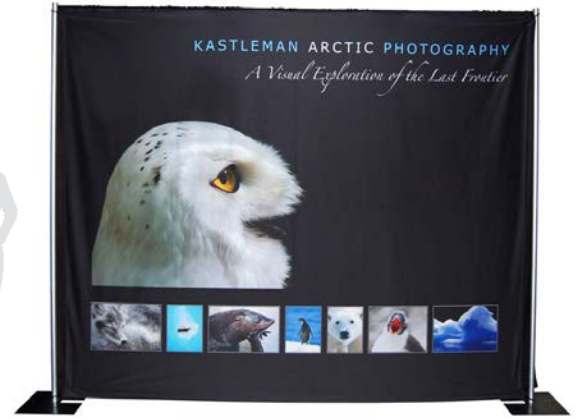

Shown on typical exhibit hall pipe & drape - Not Included.

QuickDrop™ (Colossus 8-Color Graphic 111" x 94" with Ball Bungees) \$728

Pricing

Standard QuickDrop™	Graphic Live Area	Graphic Final Size	10' x 8' Quick Drop™ w/Colossus 8-Color
10' Graphic	109" x 88"	111" x 94"	\$728*

*Price includes Graphic w/ pole pockets and hidden grommets, 5 Ball Bungees, 5 Hooks, and Black Carry Bag.

- For graphic sizes other than standard 10' use pricing below:
 - Kaleidoscope Select - \$9/sq. ft.
 - Colossus 4 color - \$9/sq. ft.
 - Colossus 8 color - \$10/sq. ft.
- Every QuickDrop™ system comes standard with Graphic w/pole pockets and hidden grommets, 5 Ball Bungees, 5 Hooks and black carry bag.
- For additional Ball Bungees and/or Hooks see Accessories section below.
- QuickDrop™ Graphics can also be used with top pole of any pipe and drape system by threading the pole through the top pole pocket.



Black carry bag, bungees and hooks.



View of Ball Bungee thru corner grommet.

Specifications

Graphic Options
Poly Knit & Brilliance

Grommets
3/8" Silver

Ball Bungee Color
Black

Shipping Weight
10ft. Standard Graphic 5.5 lbs.
(add 2 - 5 lbs. for box and packing)

Accessories

Exhibit Pipe & Drape Hook \$.50 each



Ball Bungee (Black) \$2.00 each
• White available on request





Streetags are stickers/decals designed to adhere to asphalt, sidewalks, concrete and other outdoor surfaces. Use Streetag on vertical surfaces also like concrete columns. Streetags are printed on a special material that easily adheres to most types of outdoor surfaces - horizontal and vertical alike.



Streetag graphics profile cut applied to a sidewalk

Pricing

UV Direct Print \$8.50/sqft

NOTE:

- The cleaner and smoother the surface, the better your graphic will adhere.
- Streetag is for permanent use only. Adhesive will cure quickly.



Community Event Streetag usage

Specifications

Print Process: UV direct print

Available Widths: 54" max

Material Surface: White matte

Backing Material: 4mil vinyl pressure sensitive film with adhesive.



Directional Streetag usage

IN STEP carpet graphics

In Step carpet graphics are perfect for any indoor event or trade show environment. Use them for full color exhibition flooring, mats, carpet tiles or runners to direct your audience and promote your product.



InStep carpet graphic combined with graphic display.

Pricing

Colossus 8 color Dye Sub Print \$10 per/sqft



Combine your display and floor image to make a continuous look.



In Step carpet is 1/8" thick. This includes polyester felt and rubber backing.

Specifications

- Print Process:** Dye Sublimation
- Available Widths:** 118" max
- Material Surface:** 1/8" thick Polyester Felt
- Backing Material:** 8oz. rubber to reduce sliding.

Note: InStep carpeting line up is image dependent

Due to the characteristics of InStep carpet graphics, some images can not be guaranteed for line up when piecing multiple graphics together. Maps, grids or detailed images that need line up may not match up completely in all areas.

Please work with your account representative to discuss your specific art before committing to an order with your client.

We are here to help with suggestions and address concerns to provide you the best results.

IN STEP vinyl flooring

InStep vinyl flooring is perfect to add to existing or new display environments to promote your message. Create full color flooring, directional signage, product branding and other creative product promotions.



InStep vinyl flooring combined with an iPad kiosk.

Pricing

UV Printable Vinyl Flooring
(with woodgrain texture) Price: \$10/sqft

Anti-Slip Option for Vinyl Flooring (*Allows the graphic to stay in place while providing greater traction.*)

- Anti-slip option on back of vinyl floor graphic Price: \$5/sqft



InStep vinyl flooring with an 8' tension fabric tube structure.

Specifications

Print Process: UV with white ink, Direct Print Second Surface

Available Widths: 58" max

Material Surface: 75mil UV printable vinyl flooring

Backing Material: Anti-slip backing option available.



Close up of InStep vinyl flooring with an iPad kiosk stand.

Lambda Floor Graphics

Lambda Floor graphics are great for any indoor event or trade show environment. Use them for audience directional assistance and full color brand promotion to help in the success of your next product or event.

Photo realistic floor graphics that can be profile cut to shape.



Lambda Vinyl Flooring profile cut and applied to floor.

Pricing

Lambda Duraflex with Satin Finish and Floor Grip Glue on the backside Price: \$11 sq ft

Floor Grip Glue bonds firmly to your print while the removable side provides a secure bond to floors or surfaces but allows the graphic to be removed easier.

Photo realistic floor graphics that can be profile cut to any shape.

Specifications

Print Process: Lambda process on Duraflex material

Available Widths: 48" max

Material Surface: Satin

Backing Material: Floor Grip glue.

Director Chairs

Enhance the look of your exhibit by adding Director Chairs that display your message.

Create an environment that promotes interaction between attendees and exhibitors. You can personalize a Director Chair with a company logo or sales message to match any display.

With Director Chairs, your customer will; feel welcome, relax within your environment and stay in your booth longer to hear about your company and products.



Director Chair 30" w/Dye Sublimation back & seat \$194

Pricing

Kaleidoscope Dye Sublimation

Qty	Back only Cost	Seat only Cost	Back & Seat Cost
1	\$59	\$59	\$98
2 - 3	\$44	\$44	\$78
4 - 6	\$39	\$39	\$68
7 - 10	\$34	\$34	\$58
11 - 12	\$34	\$34	\$58
13 - 49	\$29	\$29	\$53
Above 50	\$24	\$24	\$43

- Add the above price to the Director Chair Cost below to get total cost.
- If Optima is just providing dye sublimation backs and/or seats, please send existing backs and/or seats so we can exactly match size & mounting.
- Quantity pricing is based on duplicate images.

Unprinted seat and back cost \$18

Director Chair Cost

Quantity	18" Standard Chair Cost	30" Counter Chair Cost
1 - 10	\$66	\$96
11 - 49	\$63	\$93
Above 50	\$59	\$89

Perma Logo on chair back & unprinted seat

Qty	1 Color Perma Logo Cost	2 Color Perma Logo Cost	3 Color Perma Logo Cost
1	\$42	\$52	\$62
2 - 3	\$22	\$31	\$40
4 - 6	\$14	\$22	\$30
7 - 10	\$11	\$18	\$25
11 - 12	\$11	\$18	\$25
13 - 49	\$7	\$13	\$19
Above 50	\$6	\$11	\$17

- Add the above price to the Director Chair Cost below to get total cost.
- Deduct 10% from above prices if you supply the chair seat and back.
- Quantity pricing is based on duplicate images.



Director chairs in a display environment.



Director Chair w/Perma Logo back.

Director Chairs

Specifications

Shipping Weight

Standard Chair 18"10.25 lbs.
Counter Chair 30"13.85 lbs.

Director Chair colors

Natural wood, White and Black

Director Chair weight limit

Standard Chair 18" 230 lbs.
Counter Chair 30" 230 lbs.

Fabric colors choices (with a PMS color equivalent)

PMS colors are not exact interpretations of the actual fabric.

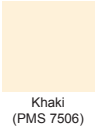

Optima offers 3 chair options in two sizes:

- 1. Kaleidoscope Dye Sublimation Chairs – the fabric on the chair is printed using our Dye Sublimation Process.
 - Dye Sublimation chair backs can have an image on both front & back; please specify when ordering.
 - Dye Sublimation chair seats have an image on the top only. Both are about the same area, thus, the same price.
 - The full size image provided for the chair back is:
 - Print Size – (Two pieces) 28.5”w x 8”h and 16.5”w x 8”h
 - Final Size – 21”w x 6.5”h
 - Message Area – 14.25”w x 5.5”h (front & back)
 - The full size image provided for the chair seat is:
 - Print Size – 22.5”w x 16.5”h
 - Final Size – 20”w x 15”h
 - Message Area – 18”w x 14”h (top only)
- 2. Perma Logo Chairs – The logos are a high temperature transfer of computer cut vinyl to the fabric (see the Perma Logo Vinyl chart for available vinyl colors).
- 3. Unprinted Chairs – includes the chair and fabric seat and back. (see above for Fabric color choices).

Accessories

Director Chair Case

Two standard height or two counter height chairs will fit in one case.
No quantity discounts are available.

41”h x 23”w x 9”d\$165



Director Chair case packing view.

TABLETHROWS

premium table solutions for any display need

With nine styles available, 6 ft and 8 ft sizes, economy and full, you can add any company logo or message to give your customer the professional look they deserve. The Poly twill fabric meets NFPA 701 small-scale fire retardant standards. Please refer to our swatch cards for available twill and Perma Logo colors. Requested black and white faxed and email proofs are available at no charge.

IMPORTANT: Table Throw fabric passes NFPA 701 Small Scale & California Section 13115



Kaleidoscope Dye Sublimation Transfer over entire Table Throw
(Backwall display not included) **\$649**

Pricing (No Set-Up charges)

Full Size Table Throws are seamed and hang to the floor on all four sides.		Economy Size Table Throws hang to the floor on three sides and the back is open.		Table Runners hang over the front of the Table Throw.	
6ft size	8ft Size	6ft size	8ft Size	24"w x 66"h	30"w x 66"h
128"w x 86"h	152"w x 86"h	128"w x 64"h	152"w x 64"h	live area 22"w x 25"h	live area 28"w x 25"h

Unprinted Table Throws (quantity discounts do not apply)

Full Size 6ft	Full Size 8ft	Economy Size 6ft	Economy Size 8ft
\$45	\$50	\$30	\$35



Table Runner on Table Throw

Perma Logo Table Throws* – (Maximum logo size is 45"w x 25"h)
Perma Logo is a computer cut vinyl material, commonly used on sports uniforms, such as football jerseys. The vinyl is transferred to any standard color twill table throw with a high temperature heat press. The vinyl is permanently adhered and will not peel, crack, or fade. It can be washed and ironed. Please refer to our Perma Logo vinyl swatch cards for available vinyl colors. Additional Perma Logo vinyl colors may be available – please call if you do not find the color you need.



Perma Logo Vinyl on Table Throw

Qty	Full Size 6ft	Full Size 8ft	Economy Size 6ft	Economy Size 8ft	Table Runner 24" x 66"	Table Runner 30" x 66"
1	\$120	\$125	\$105	\$110	\$80	\$85
2	\$105	\$110	\$90	\$95	\$65	\$70
3 - 5	\$76	\$81	\$61	\$66	\$46	\$48
6 - 30	\$71	\$76	\$56	\$61	\$36	\$38
30+	Call For Quote					

- Price includes one color. Add \$50 for each additional color per throw or runner.
- Add \$15 per throw for each color permalogo with a height greater than 13".
- Add \$10 for a Convert-a-Throw. This includes velcro tabs sewn in to convert from an 8' to 6' throw.
- Table Runner maximum image sizes are 22"w x 25"h for a 24"w x 66"h runner and 28"w x 25"h for a 30"w x 66"h.
- Add \$75 for each additional logo.

* Clean useable vector art is required. For logo clean up or recreation and text setting, standard design charges will apply. See page J-2 for art time charge amounts.

Perma Logo Vinyl colors available

A variety of perma logo vinyl colors are stocked.

All PMS colors are approximate.

Custom colors are a minimum order of 250 yards and take 2-4 weeks.



Fabric colors in stock

We stock many popular throw fabrics.

Don't see the color you need? Please call. Additional colors can be ordered.

Custom Dye Sublimation solid colors are available at additional cost - see full dye sub.

All PMS colors are approximate.



NOTE - PMS colors are approximate. For exact color matching please request a sample swatch.
 - Fabric colors pass NFPA 701 Small Scale & California Section 13115

TABLETHROWS

premium table solutions for any display need

Flocking Table Throws* – (Maximum logo size is 45" w x 25" h)

Flocking is a computer cut vinyl material with a felt like texture, commonly used on sports uniforms, such as football jerseys. It is transferred to any standard color twill table throw with a high temperature heat press. Flocking is permanently adhered and will not peel, crack, or fade. It can be washed and ironed.



Flocking close up view

Qty	Full Size 6ft	Full Size 8ft	Economy Size 6ft	Economy Size 8ft	Table Runner 24" x 66"	Table Runner 30" x 66"
1	\$130	\$135	\$115	\$120	\$90	\$95
2	\$115	\$120	\$100	105	\$75	\$80
3 - 5	\$86	\$91	\$71	\$76	\$56	\$58
6 - 30	\$81	\$86	\$66	\$71	\$46	\$48
30+	Call For Quote					

- Price includes one color. Add \$60 for each additional color per throw or runner.
- **Add \$10 for a Convert-a-Throw.** This includes velcro tabs sewn in to convert from an 8' to 6' throw.
- Table Runner maximum image sizes are 22" w x 25" h for a 24" w x 66" h runner and 28" w x 25" h for a 30" w x 66" h.

* Clean useable vector art is required. For logo clean up or recreation and text setting, standard design charges will apply. See page J-2 for art time charge amounts.

Stock Flocking colors

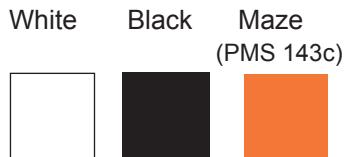

Special Order** Flocking colors

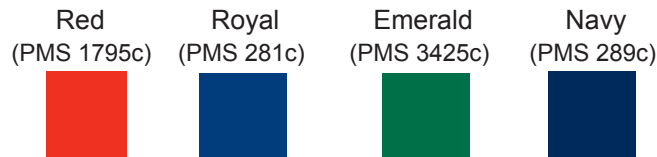

** Special Order Flocking colors will add 5 - 7 business days for production.

NOTE: PMS colors are approximate matches. Printed colors on the sheet are approximate. For best matching results refer to your PMS color book.

Kaleidoscope Dye Sublimation Applique & Perma Logo lettering

Table Throws - If your artwork consists of text and a complex logo or image, this combined process is perfect. The text is applied as a Perma Logo and photographic images, color gradations, or complex logos are printed as a Kaleidoscope Dye Sublimation applique. The applique is profile cut and then applied to the throw using an industrial 3M fabric adhesive.



Kaleidoscope Dye Sublimation Applique & Perma Logo lettering on Table Throw

Qty	Full Size 6ft	Full Size 8ft	Economy Size 6ft	Economy Size 8ft
1	\$185	\$190	\$170	\$175
2	\$170	\$175	\$155	\$160
3 - 5	\$145	\$150	\$130	\$135
6 - 30	\$140	\$145	\$125	\$130
30+	Call For Quote			

Add \$10 for a Convert-a-Throw. This includes velcro tabs sewn in to convert from an 8' to 6' throw.

TABLETHROWS

premium table solutions for any display need

Kaleidoscope Dye Sublimation Logo Applique Table Throws –

(Maximum logo size is 45”w x 25”h) This great, low cost alternative is produced by creating a dye sublimation image which is profile cut and permanently adhered to any standard color twill table throw with an industrial 3M fabric adhesive. It can be washed and ironed. It is a great solution for government and university seals, complex corporate logos or any photo image with defined edges. **NOTE:** Small detailed profile cutting of logos and text are not available.



Kaleidoscope Dye Sublimation Applique on Table Throw *

Qty	Full Size 6ft	Full Size 8ft	Economy Size 6ft	Economy Size 8ft	Table Runner 24” x 66”	Table Runner 30” x 66”
1	\$150	\$155	\$135	\$140	\$105	\$115
2	\$135	\$140	\$120	\$125	\$80	\$90
3 - 5	\$110	\$115	\$95	\$100	\$65	\$75
6 - 30	\$105	\$110	\$90	\$95	\$55	\$65
30+	Call For Quote					

Kaleidoscope Dye Sublimation Front Transfer Table Throw – The size of the dye sublimation portion is 128”w x 28”h for a 6’ throw and 152”w x 28”h for an 8’ throw. It is recommended to keep non bleed text or logo images 1.5” from top and 1.5” from bottom. This standard Kaleidoscope dye sublimation table throw is comprised of a full length front dye sublimation piece seamed to any standard color fabric with a resulting full size or economy throw. The hem falls at the front edge of the table such that the dye sublimation image is on the entire front of the throw. Dye sublimation throws are produced on white twill only.



Kaleidoscope Dye Sublimation Front Trans Table Throw *

Qty	Full Size 6ft	Full Size 8ft	Economy Size 6ft	Economy Size 8ft
1	\$250	\$297	\$240	\$282
2	\$225	\$272	\$215	\$257
3 - 5	\$210	\$257	\$200	\$242
6 - 30	\$205	\$252	\$195	\$237
30+	Call For Quote			

Kaleidoscope Dye Sublimation Transfer Over Entire Table Throw - Image size for a 6’ table is 128”w x 86”h. Image size for an 8’ table is 152”w x 86”h. This custom Kaleidoscope dye sublimation table throw allows you the flexibility of dye sublimation on the entire throw. Printed on white Poly twill, this process is perfect for featuring photographic images, color gradations or complex logos. This throw is printed in 2 pieces and seamed together to make a full or economy throw.



Kaleidoscope Dye Sublimation Transfer over entire Table Throw *

Qty	Full Size 6ft	Full Size 8ft	Economy Size 6ft	Economy Size 8ft	Table Runner 24” x 66”	Table Runner 30” x 66”
1	\$551	\$649	\$512	\$597	\$111	\$124
2	\$501	\$599	\$462	\$547	\$86	\$99
3 - 5	\$471	\$569	\$432	\$517	\$71	\$84
6 - 30	\$461	\$559	\$422	\$507	\$61	\$74
30+	Call For Quote					

* Add \$10 for a Convert-a-Throw. This includes velcro tabs sewn in to covert from an 8’ to 6’ throw.

TABLETHROWS

premium table solutions for any display need

Specifications

Care Instructions

The table throws can be machine washed cold or warm. Do not use bleach. Tumble dry on a low setting but the dryer should not exceed 120 degrees. Remove immediately to prevent wrinkling. Do not iron directly on logo, only iron on the backside of the image.

Silk Screened Logos

For larger quantity orders or exact logo color matches, please call for a quote.

Accessories

Carrying Bag\$25

Constructed of heavy duty black canvas and is designed to carry one table throw.

Perma Logo vinyl on carrying bag:

- Same logo as ordered throw..... \$60
- Different logo than ordered throw..... \$95



Carrying Bag without logo



Carrying Bag w/logo

Table throw Clip\$2

Great to secure outdoors in windy conditions and prevents slipping. Clip requires 3" of space under the table.



Throw Clip



Clip fits table edge thickness of 3/4" to 1 1/2".

Hand-Held Steamer\$58



Contour Table Throws Optima offers 6 foot, 8 foot standard contour throws. We also offer custom sized premium contour tension fabric table throws!

6' Contour Table Throw - Full Cost/throw Base Sqft Price

- Unprinted \$171.00 \$3/sqft
- Dyesub Front \$342.00 \$6/sqft
- Full Dyesub \$570.00 \$10/sqft

8' Contour Table Throw - Full Cost/throw Base Sqft Price

- Unprinted \$213.00 \$3/sqft
- Dyesub Front \$426.00 \$6/sqft
- Full Dyesub \$710.00 \$10/sqft



Convert-a-Throw Option Convert your 8ft throw to a 6ft throw then back again. Easy to do conversion takes under a minute! It's like having 2 throws in 1. **Add \$10 for a Convert-a-Throw** (This includes velcro tabs sewn in to convert from an 8' to 6' throw.)

Attach the three velcro tabs to shorten both ends of the throw and adjust.



V-THROW

More Value | No Compromise | Full Image Table Throws

V-Throw Full Dyesub table throws from Optima are seamless, wrinkle free, made of high quality dye sub V-Fabric material. It is professionally hemmed, machine washable and fire retardant.

Ordering your throw from the same place you purchase the rest of your client's display only makes sense. For no hassels, a great throw, easy ordering and a great match of color and art from throw to display or table top order from Optima.

Choose a V-Throw from Optima and save your client and money at the same time.



6ft full dyesub V-Throw
table throw \$315

Pricing

Qty	Full Size 6ft	Full Size 8ft
1	\$315	\$365
2	\$284	\$329
3 - 5	\$265	\$307
6 - 30	\$259	\$289
30+	Call for quote	Call for quote

V-Throw full dyesub table throws fit standard 6ft and 8ft tables.



Seamless, wrinkle free, made of high quality dye sub V-Fabric material.

Care Instructions

The table throws can be machine washed cold or warm. Do not use bleach. Tumble dry on a low setting but the dryer should not exceed 120 degrees. Remove immediately to prevent wrinkling.

Wind™ Table Top

The Aviator™ Table Top is a great solution with an upscale style. The black aluminum tube frame with push button assembly makes setting up quick and easy. All Aviator™ Table Top graphics are finished in the pillowcase style. Top quality dye sublimation and sturdy zippers bring the same fantastic Optima Aviator™ hanging sign graphics to these Table Tops. A hard shipping case comes included with every Aviator™ Table Top unit order.



Aviator TT Wind 79"w x 42.125"h
w/Kaleidoscope Select,
8' table throw & Light \$1,103

Pricing (includes graphic, unit, light & case)

Unit Size	Live Area	Print Size	Aviator TT Wind w/Kaleidoscope Select (Printed front only)
75"w x 43"h	59"w (up to 73"w at widest center point) x 36"h	79"w x 42.125"h	\$978

- Optional Blocker available for \$24.00
- Graphic Finishing - pillowcasing with zippers
- Double Sided graphics available. Call for a quote
- 8' table throw (as shown above) \$125

Units may be purchased without graphic \$684 each



Shipping Case (included)

5 Great shapes available - Call for more details.

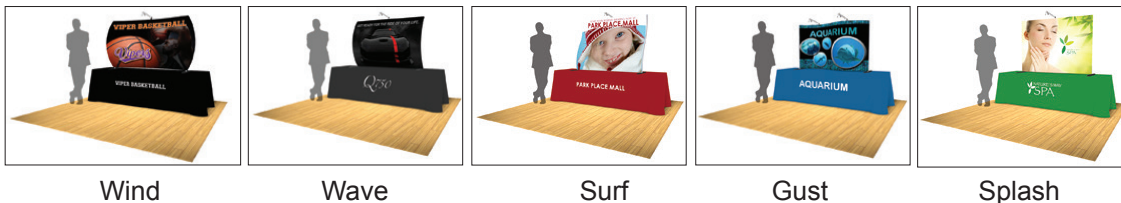

Wind

Wave

Surf

Gust

Splash

Specifications

Shipping Weight
Unit only 10.5 lbs.

Unit with Graphic 12 lbs.
Hard Case only 11 lbs.
Total ship weight 23 lbs.

Unit Color
Black

Foot Color
Black

Hard Case Dimension (included)
54.25" w x 12"d x 8"h

Unit Dimensions
(Open) 43"h x 75"w x 18.5"d (foot)

Accessories

Additional or Replacement Light
50 watt halogen w/clamp.....\$74 ea.
(available in black or silver)

Each unit includes one 50 watt halogen light. Additional and replacement lights available in Accessories below.



Light Bag
Black canvas w/ handles;
holds 2 lights.....\$30 ea.



Wave™ Table Top

The Aviator™ Table Top is a great solution with an upscale style. The black aluminum tube frame with push button assembly makes setting up quick and easy. All Aviator™ Table Top graphics are finished in the pillowcase style. Top quality dye sublimation and sturdy zippers bring the same fantastic Optima Aviator™ hanging sign graphics to these Table Tops. A hard shipping case comes included with every Aviator™ Table Top unit order.



**Aviator TT Wave 66" w x 45.5" h
w/Kaleidoscope Select,
8' table throw & Light \$1,103**

Pricing (includes graphic, unit, light & case)

Unit Size	Live Area	Print Size	Aviator TT Wave w/Kaleidoscope Select (Printed front only)
64" w x 41.5" h	60" w x 38.75" h	66" w x 45.5" h	\$978

- Optional Blocker available for \$22.00
- Graphic Finishing - pillowcasing with zippers
- Double Sided graphics available. Call for a quote
- 8' table throw (as shown above) \$125

Units may be purchased without graphic \$684 each



Shipping Case (included)

5 Great shapes available - Call for more details.



Wind

Wave

Surf

Gust

Splash

Specifications

Shipping Weight
Unit only 10 lbs.

Unit Color
Black

Unit with Graphic 12 lbs.
Hard Case only 11 lbs.
Total ship weight 23 lbs.

Foot Color
Black

Hard Case Dimension (included)
54.25" w x 12"d x 8"h

Unit Dimensions
(Open) 64" w x 41.5" h x 18.5" d (foot)

Accessories

Additional or Replacement Light
50 watt halogen w/clamp.....\$74 ea.
(available in black or silver)

Each unit includes one 50 watt halogen light. Additional and replacement lights available in Accessories below.



Light Bag
Black canvas w/ handles;
holds 2 lights.....\$30 ea.



Surf™ Table Top

The Aviator™ Table Top is a great solution with an upscale style. The black aluminum tube frame with push button assembly makes setting up quick and easy. All Aviator™ Table Top graphics are finished in the pillowcase style. Top quality dye sublimation and sturdy zippers bring the same fantastic Optima Aviator™ hanging sign graphics to these Table Tops. A hard shipping case comes included with every Aviator™ Table Top unit order.



Aviator TT Surf 65.8" w x 50.125" h
w/Kaleidoscope Select,
8' table throw & Light \$1,103

Pricing (includes graphic, unit, light & case)

Unit Size	Live Area	Print Size	Aviator TT Wave w/Kaleidoscope Select (Printed front only)
69" w x 49" h	61" w x 43.75" h	65.8125" w x 50.125" h	\$978

- Optional Blocker available for \$22.00
- Graphic Finishing - pillowcasing with zippers
- Double Sided graphics available. Call for a quote
- 8' table throw (as shown above) \$125

Units may be purchased without graphic \$684 each



Shipping Case (included)

5 Great shapes available - Call for more details.



Wind

Wave

Surf

Gust

Splash

Specifications

Shipping Weight
Unit only 14 lbs.

Unit Color
Black

Unit with Graphic 16 lbs.
Hard Case only 11 lbs.
Total ship weight 27 lbs.

Foot Color
Black

Hard Case Dimension (included)
54.25" w x 12" d x 8" h

Unit Dimensions
(Open) 69" w x 49" h x 18.5" d (foot)

Accessories

Additional or Replacement Light
50 watt halogen w/clamp.....\$74 ea.
(available in black or silver)

Each unit includes one 50 watt halogen light. Additional and replacement lights available in Accessories below.



Light Bag
Black canvas w/ handles;
holds 2 lights.....\$30 ea.



Gust™ Table Top

The Aviator™ Table Top is a great solution with an upscale style. The black aluminum tube frame with push button assembly makes setting up quick and easy. All Aviator™ Table Top graphics are finished in the pillowcase style. Top quality dye sublimation and sturdy zippers bring the same fantastic Optima Aviator™ hanging sign graphics to these Table Tops. A hard shipping case comes included with every Aviator™ Table Top unit order.

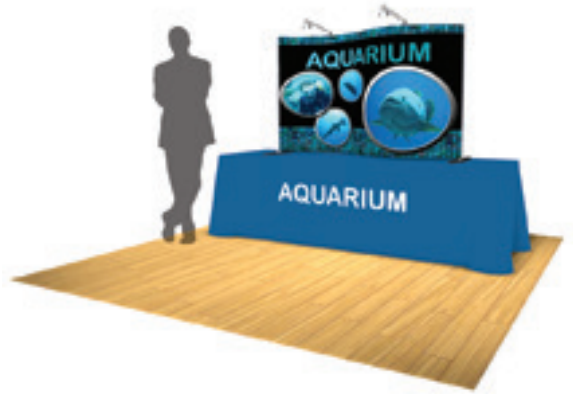

Aviator TT Gust 71.125" w x 45.8" h
w/Kaleidoscope Select,
8' table throw & 2 Lights \$1,103

Pricing (includes graphic, unit, light & case)

Unit Size	Live Area	Print Size	Aviator TT Wave w/Kaleidoscope Select (Printed front only)
72" w x 48.5" h	67" w x 42.5" h	71.125" w x 48.875" h	\$978

- Optional Blocker available for \$22.00
- Graphic Finishing - pillowcasing with zippers
- Double Sided graphics available. Call for a quote
- 8' table throw (as shown above) \$125

Units may be purchased without graphic \$684 each



Shipping Case (included)

5 Great shapes available - Call for more details.



Wind

Wave

Surf

Gust

Splash

Specifications

Shipping Weight
Unit only 14 lbs.

Unit Color
Black

Unit with Graphic 16 lbs.
Hard Case only 11 lbs.
Total ship weight 27 lbs.

Foot Color
Black

Hard Case Dimension (included)
54.25" w x 12" d x 8" h

Unit Dimensions
(Open) 72" w x 48.5" h x 18.5" d (foot)

Accessories

Additional or Replacement Light
50 watt halogen w/clamp.....\$74 ea.
(available in black or silver)

Each unit includes one 50 watt halogen light. Additional and replacement lights available in Accessories below.



Light Bag
Black canvas w/ handles;
holds 2 lights.....\$30 ea.



Splash™ Table Top

The Aviator™ Table Top is a great solution with an upscale style. The black aluminum tube frame with push button assembly makes setting up quick and easy. All Aviator™ Table Top graphics are finished in the pillowcase style. Top quality dye sublimation and sturdy zippers bring the same fantastic Optima Aviator™ hanging sign graphics to these Table Tops. A hard shipping case comes included with every Aviator™ Table Top unit order.



Aviator TT Splash 65.8125" w x 49" h w/Kaleidoscope Select, 8' tabel throw & Light \$1,103

Pricing (includes graphic, unit, light & case)

Unit Size	Live Area	Print Size	Aviator TT Wave w/Kaleidoscope Select (Printed front only)
72" w 49.75" h	61" w x 43" h	65.8125" w x 49.0625" h	\$978

- Optional Blocker available for \$22.00
- Graphic Finishing - pillowcasing with zippers
- Double Sided graphics available. Call for a quote
- 8' table throw (as shown above) \$125

Units may be purchased without graphic \$684 each



Shipping Case (included)

5 Great shapes available - Call for more details.



Wind

Wave

Surf

Gust

Splash

Specifications

Shipping Weight

Unit only 14 lbs.

Unit with Graphic 16 lbs.

Hard Case only 11 lbs.

Total ship weight 27 lbs.

Unit Color

Black

Foot Color

Black

Hard Case Dimension (included)

54.25" w x 12"d x 8"h

Unit Dimensions

(Open) 72" w 49.75" h x 18.5" d (foot)

Accessories

Additional or Replacement Light

50 watt halogen w/clamp.....\$74 ea. (available in black or silver)

Each unit includes one 50 watt halogen light. Additional and replacement lights available in Accessories below.



Light Bag

Black canvas w/ handles; holds 2 lights.....\$30 ea.



xpressions[®]
SALESMATE™ 2 x 2
EXHIBITOR SERIES



Shown on 6ft. table

SalesMate™ is one of the hottest new display options on the market. Compact, convenient and easy set-up, The SalesMate™ is small in size when traveling, upon set-up the all inclusive skins provide great impact! The SalesMate™ Exhibitor Series Kits were designed to provide turn-key table top display options that carry over the excitement and purpose of xpressions®.

The Exhibitor Series Kits include everything needed to travel and display efficiently at trade shows. Set-up is a breeze with a full size 8' throw emblazoned with a large perma logo presence. Each 8' throw can be converted to a 6' with the included velcro tabs. The SalesMate™ display comes with the graphics already on the frame.

Traveling with large displays is not always possible, choosing SalesMate™ compromises nothing except the hassle! SalesMate™ Exhibitor Series table top kits eliminate a little stress out of life. Have a great show!

Kit A:

- 2x2 SalesMate™ frame & graphic..... \$396
- 6-8ft. Convert-a-Throw, one color permalogo..... \$135
- Large Soft Carry Bag..... \$35
- Total Price..... \$566**

Shipping Weight..... 9lbs.
 (Includes frame, graphic, carry bag and Convert-a-throw in box with packaging.)

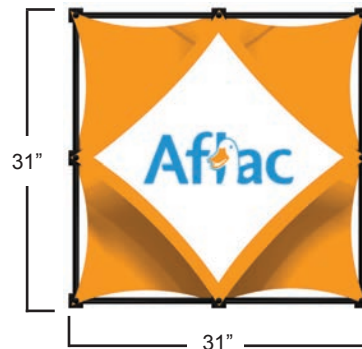

Shown on 6ft. table



Shown on 6ft. table

Kit B:

- 2x2 SalesMate™ frame & graphic..... \$478
- 6-8ft. Convert-a-Throw, one color permalogo..... \$135
- Large Soft Carry Bag..... \$35
- Total Price..... \$648**

Kit C:

- 2x2 SalesMate™ frame & graphic..... \$396
- 6-8ft. Convert-a-Throw, one color permalogo..... \$135
- Large Soft Carry Bag..... \$35
- Total Price..... \$566**



Shown on 6ft. table



Shown on 6ft. table

Kit D:

- 2x2 SalesMate™ frame & graphic..... \$396
- 6-8ft. Convert-a-Throw, one color permalogo..... \$135
- Large Soft Carry Bag..... \$35
- Total Price..... \$565**

Kit E:

- 2x2 SalesMate™ frame & graphic..... \$478
- 6-8ft. Convert-a-Throw, one color permalogo..... \$135
- Large Soft Carry Bag..... \$35
- Total Price..... \$646**



Large Soft Carry Bag

xpressions[®]
SALESMATE™
EXHIBITOR SERIES

3 Quad



Shown on 6ft. table

SalesMate™ is one of the hottest new display options on the market. Compact, convenient and easy set-up, The SalesMate™ is small in size when traveling, upon set-up the all inclusive skins provide great impact! The SalesMate™ Exhibitor Series Kits were designed to provide turn-key table top display options that carry over the excitement and purpose of xpressions®.

The Exhibitor Series Kits include everything needed to travel and display efficiently at trade shows. Set-up is a breeze with a full size 8' throw emblazoned with a large perma logo presence. Each 8' throw can be converted to a 6' with the included velcro tabs. The SalesMate™ display comes with the graphics already on the frame.

Traveling with large displays is not always possible, choosing SalesMate™ compromises nothing except the hassle! SalesMate™ Exhibitor Series table top kits eliminate a little stress out of life. Have a great show!

Kit A:

- 3Quad SalesMate™ frame & graphic..... \$314
- 6-8ft. Convert-a-Throw, one color permalogo..... \$135
- Large Soft Carry Bag..... \$35
- Total Price..... \$484**

- Shipping Weight..... 8lbs.
- (Includes frame, graphic, carry bag and Convert-a-throw in box with packaging.)



Shown on 6ft. table



Shown on 6ft. table

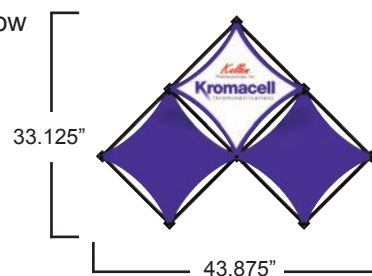

Large Soft Carry Bag

Kit B:

- 3Quad SalesMate™ frame & graphic..... \$314
- 6-8ft. Convert-a-Throw, one color permalogo..... \$135
- Large Soft Carry Bag..... \$35
- Total Price..... \$484**

Kit C:

- 3Quad SalesMate™ frame & graphic..... \$396
- 6-8ft. Convert-a-Throw, one color permalogo..... \$135
- Large Soft Carry Bag..... \$35
- Total Price..... \$566**



Shown on 6ft. table



Shown on 6ft. table

Kit D:

- 3Quad SalesMate™ frame & graphic..... \$314
- 6-8ft. Convert-a-Throw, one color permalogo..... \$135
- Large Soft Carry Bag..... \$35
- Total Price..... \$484**

Kit E:

- 3Quad SalesMate™ frame & graphic..... \$314
- 6-8ft. Convert-a-Throw, one color permalogo..... \$135
- Large Soft Carry Bag..... \$35
- Total Price..... \$484**

xpressions[®]
SALES MATE™
 EXHIBITOR SERIES 4 x 3



SalesMate™ is one of the hottest new display options on the market. Compact, convenient and easy set-up, The SalesMate™ is small in size when traveling, upon set-up the all inclusive skins provide great impact! The SalesMate™ Exhibitor Series Kits were designed to provide turn-key table top display options that carry over the excitement and purpose of xpressions®.

The Exhibitor Series Kits include everything needed to travel and display efficiently at trade shows. Set-up is a breeze with a full size 8' throw emblazoned with a large perma logo presence. Each 8' throw can be converted to a 6' with the included velcro tabs. The SalesMate™ display comes with the graphics already on the frame.

Traveling with large displays is not always possible, choosing SalesMate™ compromises nothing except the hassle! SalesMate™ Exhibitor Series table top kits eliminate a little stress out of life. Have a great show!

Kit A:

- 4 x 3 SalesMate™ frame & graphic..... \$1,588
- 8ft. Convert-a-Throw, one color permalogo..... \$135
- Large Soft Carry Bag..... \$35
- Total Price..... \$1,758**



Kit B:

- 4 x 3 SalesMate™ frame & graphic..... \$1,252
- 8ft. Convert-a-Throw, one color permalogo..... \$135
- Large Soft Carry Bag..... \$35
- Total Price..... \$1,422**



Shipping Weight..... 15lbs.
 (Includes frame, graphic, carry bag and Convert-a-throw in box with packaging.)



Large Soft Carry Bag



Kit C:

- 4 x 3 SalesMate™ frame & graphic..... \$1,246
- 8ft. Convert-a-Throw, one color permalogo..... \$135
- Large Soft Carry Bag..... \$35
- Total Price..... \$1,416**

Kit D:

- 4 x 3 SalesMate™ frame & graphic..... \$1,500
- 8ft. Convert-a-Throw, one color permalogo..... \$135
- Large Soft Carry Bag..... \$35
- Total Price..... \$1,670**



A La Carte Graphic Wholesale Pricing

Quads / Description / Pricing			Skin Size	
1x1	Flat	\$42	13.375"w	x 13.375"h
1x1	Single Twist	\$42	14.25"w	x 14.25"h
1x1	Double Twist	\$42	14.75"w	x 14.75"h
1x1	Thread (h)	\$42	15"w	x 13.375"h
1x1	Thread (v)	\$42	13.375"w	x 15"h
Hex Skin Size				
1x2	Flat	\$82	13.375"w	x 26.25"h
1x2	Thread	\$82	13.375"w	x 28"h
1x2	Double Thread	\$82	13.375"w	x 29"h
1x2	Single Twist	\$82	13.375"w	x 26.75"h
1x2	Double Twist	\$82	13.375"w	x 27"h
Triangle				
1x3	Flat	\$126	13.375"w	x 39.5"h
1x3	Double Thread	\$126	13.375"w	x 43.375"h
1x3	Single thread	\$126	13.375"w	x 41.375"h
Star				
2x1	Flat	\$82	26.25"w	x 13.375"h
2x1	Thread	\$82	28"w	x 13.375"h
2x1	Double Thread	\$82	29"w	x 13.375"h
2x1	Single Twist	\$82	26.75"w	x 13.375"h
2x1	Double Twist	\$82	27"w	x 13.375"h
Diamond				
4x1	Flat	\$164	52.25"w	x 13.375"h
4x3	Flat	\$445	52.25"w	x 41"h
Other Shapes				
	Diamond	\$82	19.75"w	x 19.75"h
2x2	Flat	\$168	27"w	x 27"h
3x3	Flat	\$378	41"w	x 41"h
	Hex*	\$252	26.25"w	x 41"h
	Star	\$42	13.375"w	x 13.375"h
	Triangle	\$28	13.375"w	x 13.375"h

Frame Only Pricing	
Frame Size	Price
2x2	\$200
3 Quad Pyramid	\$160
4x3	\$664

*Hex Skin Size

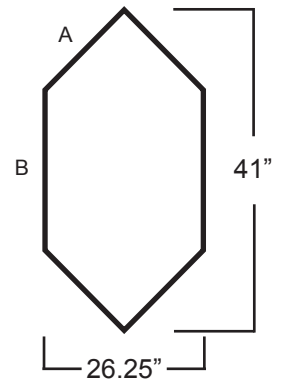

A = 18.87"
B = 13.375"

Duplicate Discounts	
Quantity	Discount Factor (frame & graphic skins)
1	1.0
2-5	.97
6-10	.96
11-15	.95
16-25	.94
Above 50	Please Request Quote
Graphic Kits	
Deduct 10% from the sum of the cost of the graphics in that kit.	



The UltraLight X is the preeminent line of portable briefcase displays on the market. The remarkable UltraLight X offers plenty of display real estate, yet easily folds into a slim portfolio-style, self-enclosed case.

Each UltraLight X series display weighs between 5 and 10 pounds. That's about half the weight of an average laptop computer or well-stuffed handbag. Weather you're looking for a budget-friendly permanent display, a mobile sales presentation unit or a complete branded identity solution, our road-tested UltraLight X line can meet your needs. **Go to Page T-3** to combine your UltraLight X display with a Table Throw.

Kit Prices: (Kit includes 3 Graphics, Briefcase Display & Carry Bag)



X18

\$295 (Lambda Bright Graphics w/laminate)
\$242 (UV Prints on .030 styrene)

Kit with optional 6"h x 22.5"w 1/8" sintra header & clips:

\$299 (Lambda Bright Graphics w/laminate)
\$246 (UV Prints on .030 styrene)

\$107 Replacement set of 3 Lambda Bright Graphics w/laminate

\$32 Replacement set of 3 UV Prints on .030 styrene

Graphic Sizes:

Center - 16.5"h x 22.5"w
 Side - 16.5"h x 10.5"w ea

Optional Header Dims:
 6"h x 22.5"w

Briefcase Dims:

Closed - 18"h x 24"w
 Open - 18"h x 48"w

Weight: 5 lbs.



X24

\$364 (Lambda Bright Graphics w/laminate)
\$284 (UV Prints on .030 styrene)

Kit with optional 6"h x 22.5"w 1/8" sintra header & clips:

\$368 (Lambda Bright Graphics w/laminate)
\$287 (UV Prints on .030 styrene)

\$154 Replacement set of 3 Lambda Bright Graphics w/laminate

\$44 Replacement set of 3 UV Prints on .030 styrene

Graphic Sizes:

Center - 22.5"h x 22.5"w
 Side - 22.5"h x 10.5"w ea

Optional Header Dims:
 6"h x 22.5"w

Briefcase Dims:

Closed - 24"h x 24"w
 Open - 24"h x 48"w

Weight: 6.5 lbs.



X32

\$440 (Lambda Bright Graphics w/laminate)
\$354 (UV Prints on .030 styrene)

Kit with optional 8"h x 22.5"w 1/8" sintra header & clips:

\$449 (Lambda Bright Graphics w/laminate)
\$363 (UV Prints on .030 styrene)

\$179 Replacement set of 3 Lambda Bright Graphics w/laminate

\$59 Replacement set of 3 UV Prints on .030 styrene

Graphic Sizes:

Center - 30.5"h x 22.5"w
 Side - 30.5"h x 10.5"w ea

Optional Header Dims:
 8"h x 22.5"w

Briefcase Dims:

Closed - 32"h x 24"w
 Open - 32"h x 48"w

Weight: 8.25 lbs.



XP

\$440 (Lambda Bright Graphics w/laminate)
\$354 (UV Prints on .030 styrene)

Kit with optional 8"h x 30.5"w 1/8" sintra header & clips:

\$454 (Lambda Bright Graphics w/laminate)
\$368 (UV Prints on .030 styrene)

\$179 Replacement set of 3 Lambda Bright Graphics w/laminate

\$59 Replacement set of 3 UV Prints on .030 styrene

Graphic Sizes:

Center - 22.5"h x 30.5"w
 Side - 22.5"h x 14.5"w ea

Optional Header Dims:
 8"h x 30.5"w

Briefcase Dims:

Closed - 24"h x 32"w
 Open - 22"h x 64"w

Weight: 8.25 lbs.



The UltraLight X is the preeminent line of portable briefcase displays on the market. The remarkable UltraLight X offers plenty of display real estate, yet easily folds into a slim portfolio-style, self-enclosed case.

Each UltraLight X series display weighs between 5 and 10 pounds. That's about half the weight of an average laptop computer or well-stuffed handbag. Whether you're looking for a budget-friendly permanent display, a mobile sales presentation unit or a complete branded identity solution, our road-tested UltraLight X line can meet your needs. **Go to Page T-3** to combine your UltraLight X display with a Table Throw.

Kit Prices: (Kit includes 3 Graphics, Briefcase Display & Carry Bag)



XX

\$554 (Lambda Bright Graphics w/laminate)
\$439 (UV Prints on .030 styrene)

Kit with optional 8" h x 30.5" w 1/8" sintra header & clips:

\$568 (Lambda Bright Graphics w/laminate)
\$453 (UV Prints on .030 styrene)

\$241 Replacement set of 3 Lambda Bright Graphics w/laminate

\$81 Replacement set of 3 UV Prints on .030 styrene

Graphic Sizes:

Center - 30.5" h x 30.5" w
 Side - 30.5" h x 14.5" w ea

Optional Header Dims:
 8" h x 30.5" w

Briefcase Dims:

Closed - 32" h x 32" w

Open - 32" h x 64" w

Weight: 8.25 lbs.



524

\$481 (Lambda Bright Graphics w/laminate)
\$366 (UV Prints on .030 styrene)

Kit with optional 8" h x 22.5" w 1/8 sintra header & clips:

\$490 (Lambda Bright Graphics w/laminate)
\$375 (UV Prints on .030 styrene)

\$222 Replacement set of 3 Lambda Bright Graphics w/laminate

\$68 Replacement set of 3 UV Prints on .030 styrene

Graphic Sizes:

Center - 22.5" h x 22.5" w
 Side - 22.5" h x 10.5" w ea

Optional Header Dims:
 6" h x 22.5" w

Briefcase Dims:

Closed - 24" h x 24" w

Open - 24" h x 48" w

Weight: 6.5 lbs.



532

\$458 (Lambda Bright Graphics w/laminate)
\$430 (UV Prints on .030 styrene)

Kit with optional 8" h x 22.5" w 1/8 sintra header & clips:

\$472 (Lambda Bright Graphics w/laminate)
\$444 (UV Prints on .030 styrene)

\$255 Replacement set of 3 Lambda Bright Graphics w/laminate

\$92 Replacement set of 3 UV Prints on .030 styrene

Graphic Sizes:

Center - 30.5" h x 22.5" w
 Side - 30.5" h x 10.5" w ea

Optional Header Dims:
 8" h x 30.5" w

Briefcase Dims:

Closed - 32" h x 24" w

Open - 32" h x 48" w

Weight: 8.25 lbs.



Closed Display View



Carry Bag

Header Shapes



Arched

Angle Cut

Rectangle

iPad Kiosk

Enhance the experience of your graphic display with iPad Kiosks as media stations for your audience.

Create multiple interactive areas or add to the multi-media direction you have designed for your event. Expand your message, continue the conversation on social media avenues or give visitors a place to catch up.

The addition of iPad Kiosks can bring a multi media experience to your message.

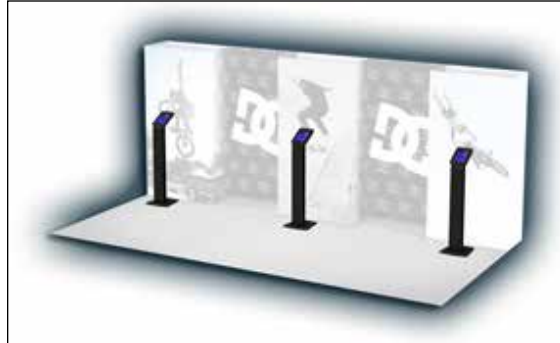

iPad Kiosk 54" h x 15.5" d
\$300
iPad 2 not included

Pricing

54" h x 15.5" d black or silver iPad Kiosk \$300

NOTE: Supports iPad 2 and new iPad only. Does not accept the original iPad device.

Graphic Option	Size	Price
Front Graphic, Controltac (on front of stand)	5" x 40"	\$14
iPad Holder Halo, 1/4" White Sintra w/graphics (around ipad clamshell holder)	Various**	\$30*
iPad Holder Halo, 1/4" Black Sintra w/graphics (around ipad clamshell holder)	Various**	\$35*
White Sintra w/graphics (on iPad holder clamshell face) †	8.25" x 11.75"	\$29*
Black Sintra w/graphics (on iPad holder clamshell face, Black Sintra requires extra flood of white ink) †	8.25" x 11.75"	\$32*
White or Black Sintra blank (on iPad holder clamshell face) †	8.25" x 11.75"	\$15*



Graphic options available for the iPad Kiosk.



Locks to secure iPad at show.



iPad Kiosk close up.

* Price includes profile cuts for radius corners.
 † Protects iPad from accidental or unauthorized home button access.
 ** Custom shapes available. Call for a quote.

● Specifications

Shipping Weight

- Without Shipping case: 24lbs. (add 2 - 5 lbs. for box and packing)
- With Shipping case: 58lbs

Kiosk breaks down into three segments to ship, Base, Support and iPad clamshell holder. (Note: Base is actually two pieces.)

Shipping Box

Size: 12" x 12" x 55"

Colors

Black & Silver available

Material

Steel/Aluminum

● Accessoriess



Shipping Case

26"w x 11"d x 56"h
Weight: 34 lbs. (empty)
Price \$257



View inside of case with packaging.

Various iPad Halo Options available: See Graphic Options for pricing.



Graphic Halo A



Graphic Halo B



Graphic Halo C

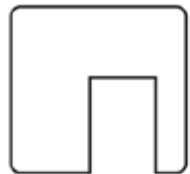

Graphic Halo D



Graphic Halo E

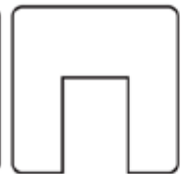

Graphic Halo F

iPad Clamshell

Increase attendee engagement and stop traffic by incorporating these iPad clamshell style holders. The iPad holders mount to extrusion systems like Panoramic or Modul easily.

Custom builders can mount these holders to hard builds for large exhibit spaces or for use in museum exhibits. These iPad holders lock for added security during busy events. Add a black, white or graphic cover to the face of your iPad holder and prevent accidental or unauthorized home button use.

Available in silver or black. For free standing iPad integration, see iPad Kiosks.



(Supports iPad 2 and new iPad only. Does not accept the original iPad device. iPad 2 not included.)

iPad Clamshell
12" h x 8.25" w x 1" d - Price \$75
iPad 2 not included

Pricing

Non-Swivel Version

Price: \$75 each

Weight: 5lbs

Dimensions: 1" d x 8.25" w x 12" h (clamshell only)

Extrusion Attachment: 5" long

Color: Silver

Material: Aluminum with powder coated silver

Swivel Version

Price: \$115 each

Weight: 6lbs

Dimensions: 1.5" d x 8.25" w x 12" h (clamshell only)

Extrusion Attachment: 5" long

Color: Silver

Material: Aluminum with powder coated silver



iPad Clamshell can be mounted to:

- Panoramic
- Nouveau
- Modul
- Agam

(call for availability)

View of iPad clamshells/holders with a display.



Graphic Option	Size	Price
iPad Holder Halo, 1/4" White Sintra w/graphics (around ipad clamshell holder)	Various**	\$30*
iPad Holder Halo, 1/4" Black Sintra w/graphics (around ipad clamshell holder)	Various**	\$35*
White Sintra w/graphics (on iPad holder clamshell face) †	8.25" x 11.75"	\$29*
Black Sintra w/graphics (on iPad holder clamshell face, Black Sintra requires extra flood of white ink) †	8.25" x 11.75"	\$32*
White or Black Sintra blank (on iPad holder clamshell face) †	8.25" x 11.75"	\$15*

* Price includes profile cuts for radius corners.

† Protects iPad from accidental or unauthorized home button access.

** Custom shapes available. Call for a quote.

iPad Clamshell Swivel

Increase attendee engagement and stop traffic by incorporating these iPad clamshell style holders. The iPad holders mount to extrusion systems easily. With the swivel option you receive even more accessibility.

Custom builders can mount these holders to hard builds for large exhibit spaces or for use in museum exhibits. These iPad holders lock for added security during busy events. Add a black, white or graphic cover to the face of your iPad holder and prevent accidental or unauthorized home button use. Available in silver or black. For free standing iPad integration, see iPad Kiosks.

(Supports iPad 2 and new iPad only. Does not accept the original iPad device. iPad 2 not included.)



iPad Clamshell Swivel
12" h x 8.25" w x 1.5" d
Price \$115 iPad 2 not included

Pricing

Price: \$115 each - *iPad 2 not included.*

(Supports iPad 2 and new iPad only. Does not accept the original iPad device.)

Weight: 6lbs

Dimensions: 1.5" d x 8.25" w x 12" h (clamshell only)

Extrusion Attachment: 5" long

Color: Silver

Material: Aluminum with powder coated silver

iPad Clamshell can be mounted to:

- Panoramic
- Nouveau
- Modul
- Agam (call for availability)

View of iPad clamshell swivel with a display rotation.



iPad Custom Kiosk

The big Custom Cut Substrate graphic draws users in directly to your iPad App or presentation. With looks that will compliment any high-end environment, this iPad Kiosk is right at home in long-term retail or large trade show displays. Because the graphic is integrated into the hardware that holds the iPad tablet, the kiosk works as one.

Add graphics to the faceplate of the iPad tablet clamshell and the fin that runs perpendicular to the large graphic. Your brand will be seen from all sides and from a good distance while the locking clamshell securely holds the iPad tablet.

Vertical or horizontal positioning of the clamshell is possible. Finished in white, and with enough advanced warning, other powder-coated colors are possible. Call for details.



**iPad Custom Kiosk
with single sided sintra graphic
Price \$733**

Pricing

Pad Custom Kiosk:

Price \$635 for qty 1 to 10
Call for a quote for quantities over 10.

Single Sided Graphic

(18" x 72" on 1/2" sintra)
Price \$98 for qty 1
Call for a quote for quantities over 1.

Double Sided Graphic:

(18" x 72" on 1/2" sintra)
Price \$172 for qty 1
Call for a quote for quantities over 1.

Graphic Live Area:

21.5" from top down
(The Kiosk interferes with imagery past the point of 21.5" from top)

NOTE:

Kiosk Base Design may vary depending on manufacturer's date.

7 to 10 Day Lead Time for all orders.

Specifications

Kiosk Dims - 11.5"w x 46"h
Kiosk Base Dims - 9" x 11.5" x 17.5"
(Kiosk Base Design may vary depending on manufactureres date)

Kiosk Weight: 12lbs
Kiosk & Shipping Case Weight: 30lbs

Colors: Silver, Black and White



The main advantage of this kiosk over other kiosks is its large substrate graphic that can be shaped to meet any brand's needs. Add people cut-outs or product representations that will be recognized instantly, drawing your target audience in to interact with your iPad tablet presentation.

Perfect for retail, museums, universities, sports facilities, medical venues as well as large trade show exhibits that have crates to transport the large graphics.



The 2N1 brings you the best of both worlds. An all inclusive backlit podium or a backlit table top display, and best of all it's easy to use. The 2N1 sets up in 30 seconds and breaks back down just as quickly. The backlit front graphic is complimented by opaque side graphics both in podium and table to applications. When used as a podium the top can support up to 150 lbs safely while the inside shelf stores all your stuff out of site. The top has plenty of space for card readers, monitors, food preparation equipment or products. Electrical cords disappear neatly into the top through a small access hole. More than a podium the 2N1 is a true work station. As a backlit table top display the 2N1 has a unique concave / convex shape that is sure to attract attention. The display fits perfect on a six foot table. Durable, stable, versatile, the 2N1 is perfect for trade shows, retail and food product demonstrations, mobile marketing events, and much more. All inclusive, your display collapses protecting your graphics and easily is rolled to its next location.



2N1 unit w/duratrans front & Lambda Bright side wing panels \$1,269

Pricing

Front Duratrans Graphic	Side Wing Panel - Detachable (Lambda Bright w/velcro)	Side Wing Panel - Direct Print (UV direct print vinyl)	Side Wing Panel - Detachable (UV direct print .040 styrene w/ velcro)
\$164	\$65ea	\$46ea	\$44ea

NOTE: - For a non-standard graphic size, determine the graphic price from the appropriate price list.
 - Custom hardware widths not available.

2N1 UNIT (without graphic)\$975

FOR COUNTER & HEADER

Quantity	Discount Factor
2-5	.98
6-10	.97
11-15	.96
16-25	.95
26-50	.94
Above 50	Call for quote

2N1 unit closed up with wheels



2N1 unit used as a table top display

Specifications

Unit weight
41 lbs.

Unit dimensions
Open34"W x 36"H x 26"D
Closed34"W x 35"H x 9"D

Shelves
Top shelf can hold50lbs.
Inside shelf can hold...60lbs.

Graphic dimensions
Front31.5"W x 33"H
Side Wing Panel
(1"radius corners)15"W x 31"H



Big things do come in small packages! Simply remove your portable display and accessories from the case. Set up the flexible tambour around the case and lid, slide in the connector to secure the tambour, fit the top on and then you are ready to go. With dyesublimation fabric wrap the Little Giant is a great addition to your display. The best part is you will be surprised to see how much display fits in your Little Giant.



See page : PK-8 for Pronto Little Giant kits
PK-9 for Xpressions Little Giants kits

Little Giant complete case-to-counter kit price \$510

Pricing

Components To Case-To-Counter	Case	Top	Tambour	Connector
Price	\$160	\$110	\$45	\$15
Materials	Molded Plastic	Wood	Fluted PVC	Aluminum
Finish	Pebble	Mahogant/Beech	Matte	Clear Anodized
Color	Grey	Dark/Light	White	Silver

Graphic Options

Kaleidoscope Select / Colossus Dye-sublimation:
Elastic is sewn in the bottom and a nylon cord is at the top for fabric graphic application to the case.

- Complete case-to-counter kit Price..... \$510.00
- Recycled fabric option kit Price..... \$528.00
- Fabric replacement graphic..... \$180.00
- Recycled fabric replacement graphic..... \$198.00
- Print area..... 36.75”w x 65.25”h
- Live (front)..... 15”w x 31”h
- Final size..... 35.5”w x 64.25”h



View of case placement.

Specifications

Case Weight
12 lbs.
(add 2 - 5 lbs. for box and packing)

Case Dims (closed and packed)
(Inside) 36.5”H x 10.25”D
(Outside) ... 40”H x 14”D x 13”

Case Dims (set-up)
35.75”H x 15”D x 29”W
counter holds up to 50lbs. evenly distributed on top.



Mahogany top finish



Beech top finish

xpressions® 223Counter™

The Xpressions® 223™ Counter is both unique and functional. The Xpressions® Frame with folding black counter top combine for a sturdy but portable solution. Covered in Xpressions® fabric graphics, this counter doesn't have a bad side! Easy access through the back of the skin allows for storage inside where you will find a small convenient shelf*. The Xpressions® 223™ Counter goes with every other Xpressions® display and works just as well with other types of exhibits. It looks complete when used on it's own or in groups. Xpressions® 223™ Counter is different. It's functional and it's familiar all at the same time. A reliable portable Counter from the display line that truly defies tradition.

* Internal shelf is optional.



Xpressions 223 Counter
w/dyesub printed
counter wrap \$470

Pricing

Counter (lower section)

Frame & Counter Top	Dyesub Printed Wrap	Unprinted Wrap	Dyesub Printed wrap w/ zippers	Unprinted wrap w/ zippers
\$200	\$270	\$135	\$297	\$149



View of optional
Internal shelf

Specifications

Counter Frame

Open: 24" x 24" x 36"h
Collapsed: 5" x 5" x 40"h

Counter Top

Open: 24" x 24" x 1"
Collapsed: 12" x 24" x 1"

Material: Aluminum/Sintra
Color: Black

Shipping Box

Size: 15" x 15" x 45"

Accessories

Shipping Case

G case 42"h x 16"d
Price \$120

Internal Shelf (optional)

17.5" x 17.5" Price ... \$95

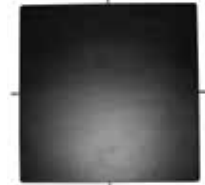



Soft Image Counter is a sleek and sturdy meeting point. Use on its own or with a Pop Up Display to create a coordinated environment.

Soft Image Counter is not available without graphic.



Soft Image Counter w/Poly Knit graphic & endcaps \$447

Pricing (Includes padded carry bag)

Soft Image Counter w/Kaleidoscope Select		Soft Image Counter w/4 Color Colossus		Soft Image Counter w/8 Color Colossus	
(w/o endcaps)	(w/endcaps)	(w/o endcaps)	(w/endcaps)	(w/o endcaps)	(w/endcaps)
\$399	\$450	\$398	\$450	\$411	\$470

Graphic Only:
w/o endcaps \$108
w/endcaps \$160

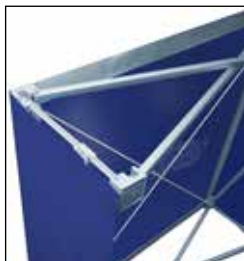

Soft Image Counter top view with graphic attached.



Soft Image Counter backview. The inner shelf makes it easy to store material.



Soft Image Counter unit, Carry Bag, Top and Counter

Specifications

Counter Weight
19.2 lbs.
(add 2 - 5 lbs. for box and packing)

Counter Dims (set-up)
39"H x 15"D x 39"W

Counter Top
42"H x 0.5"D x 15.5"W

Shipping Box
44 x 18 x 10

Counter Top Color
• Stone (black speckled)

Material Available
Poly Knit
Brilliance

Weight Limits
Top Shelf = 60 lbs
Internal Shelf = 35 lbs.

Accessories

Shipping case
Black w/ wheels \$180.00

Case Dimension
(Outside) ... 28"w x 52"h x 9.5"d
(Inside) 24"w x 48" h x 9"d



Clear Top Counter Modesto™

The Modesto clear top counter will enhance any display. Use it as a podium, counter, media stand, resource center etc. The options are endless.

Constructed of polished aluminum poles and European Birch finish over plywood, with your choice of solid colored or printed sintra panels, Modesto clear top counters will add style to your display.

No tools are required and assembly can be completed in about a minute.



Modesto Counter w/Kaleidoscope Select graphic \$498

Pricing (includes graphic & counter)

Dyesub

Modesto Unit Size	Actual Graphic Print Size	Live Area	Kaleidoscope Select Graphic cost	Modesto Counter cost	Total
23"w x 40.5"h	83.5"w x 31"h	16.25"w x 28"h (centered)	\$178	\$320	\$498



Modesto counter with 1/8" UV direct print sintra graphic panels \$452

UV direct print

Modesto Unit Size	1/8" Sintra print size	1/8" Sintra UV direct print Panel cost	Modesto Counter cost	Total
23"w x 40.5"h	18" x 30.5"	\$132 (\$33 x 4 panels)	\$320	\$452

Lambda

Modesto Unit Size	Lambda print size	Modesto w/4 Lambda Bright graphics mounted to 1/8" sintra	Modesto w/4 Lambda Duraflex graphics mounted to 1/8" Sintra	Modesto w/4 Lambda Metallic graphics mounted to 1/8" sintra
23"w x 40.5"h	18" x 30.5"	\$736	\$804	\$804

Specifications

Shipping Box
48" x 26.5" x 4"

Shipping Weight
Counter only 28 lbs.

Counter w/dyesub graphics in shipping box 30 lbs.

Counter w/sintra graphic panels (4) in shipping box 44 lbs.

Counter w/dyesub graphics in hard shipping case 53 lbs.

Counter w/sintra graphic panels (4) in hard shipping case 67 lbs.

Counter Dims (set-up)
40.5"H x 23"D x 23"W

Counter Top Dim
23" x 23"

Counter Top Colors
• Clear plexi Top
• Birch Shelf

Graphic Material Available
• Dyesub fabric
• 1/8" Sintra

Print Process
• Dye Sub • UV direct print • Lambda

Shelf Weight Limits
200lbs. per shelf

Accessories

Hard Shipping case
Black w/ wheels \$180.00

Case Dimension
(Outside) ... 28"w x 52"h x 9.5"d
(Inside) 24"w x 48" h x 9"d



xpressions® 223 Workstation™

The Xpressions® 223™ Workstation is both unique and functional. The Xpressions® Frame with folding black counter top and vertical monitor mount combine for a sturdy but portable workstation solution. Covered in Xpressions® fabric graphics, the counter and the vertical monitor mount carry your brand 360 degrees. This workstation doesn't have a bad side! Easy access through the back of the skin allows for storage inside where you will find a small convenient shelf*. The Xpressions® 223™ Workstation goes with every other Xpressions® displays and works just as well with other types of exhibits. It looks complete when used on it's own or in groups of workstations. Xpressions® 223™ Workstation is different. It's functional and it's familiar all at the same time. A reliable portable workstation from the display line that truly defies tradition.

* Internal shelf is optional.



Xpressions 223 Workstation w/dyesub printed counter and monitor stand wrap \$647

Monitor not included

Pricing

Counter (lower section)

Frame & Counter Top	Dyesub Printed Wrap	Unprinted Wrap	Dyesub Printed wrap w/ zippers	Unprinted wrap w/ zippers
\$200	\$270	\$135	\$297	\$149

Counter top can hold approx. 50lbs. Internal shelf can hold approx. 50lbs. Total weight placed on top & internal shelf combined not to exceed 75lbs.

Monitor Stand (section above counter)

Monitor stand & Bracket	Dyesub Printed Wrap	Unprinted Wrap
\$126	\$51	\$25.50

- Depending on the monitor, a 32" monitor has been used.
- Bracket is designed to accept most standard monitor mounts. Please ensure your monitor has an appropriate monitor mount to allow attaching to monitor bracket.

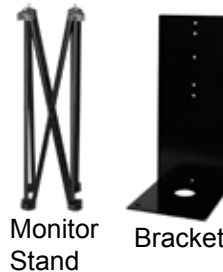

View of optional Internal shelf

Specifications

Counter Frame
Open: 24" x 24" x 36"h
Collapsed: 5" x 5" x 40"h

Counter Top
Open: 24" x 24" x 1"
Collapsed: 12" x 24" x 1"

Monitor Stand
Open: 7" x 7" x 20.5"h
Collapsed: 5" x 5" x 21.5"h

Bracket (For mounting computer)
7" x 7" x 15.5"h

Material: Aluminum/Sintra
Color: Black

Shipping Box
Size: 15" x 15" x 45"

Counter Weight
w/o monitor: 16lbs.

Accessories

Shipping Case
G case 42"h x 16"d
Price \$120

Internal Shelf (optional)
17.5" x 17.5" Price ... \$95



Monitor Mount \$68 ea.
(May not hold all monitor types.)



xpressions[®]

MONSTER MONITOR TOWER[™]

IT's ALIVE!!!!

A Monster Monitor Requires A Monster Tower.

As the rental and purchase price of monitors goes down their presence at tradeshows is increasing along with their size! Large-sized monitors are everywhere. A monster monitor needs a monster stand and Xpressions Monster Monitor tower is up to the challenge. Holds up to a 55" monitor (we've used a 60" with no problem!) Best part about this strong monitor tower is that it's Xpressions... Up fast and down even faster and it's style matches your Xpressions display perfectly!



Monitor not included.

Xpressions Tower, monitor mount, shelf & two Xpressions graphics - Price \$1,030

Pricing

- Xpressions Monster Monitor Tower with monitor mount and shelf \$752
- 1x1 Flat Xpressions skin \$98
- 1x2 Verticle Xpressions skin \$180

Total Kit Price \$1,030 each

(Suggested max size and weight for monitor tower is 55" and max weight is 70lbs. Monitor Tower has been tested with a monitor 60" at 75lbs. successfully.)

Total Weight: 25lbs.

- Tower - 10lbs
- Monitor Mount - 10lbs
- Shelf - 5lbs

Dimensions:

- Tower - 24"d x 30"w x 88"h (open)
- 7"d x 5"w x 63"L (collapsed)
- Monitor Mount - 30" x 30" (open)
- Black Shelf - 28.5" x 12" (open)

Color: Black

Shipping Box Size: 10" x 10" x 66"

Hard Shipping Case Available

- Size: 70" x 16" x 14"
- Weight: 20lbs
- Price \$260



Shipping Case closed



Shipping Case open



Easily attach the monitor mount to the tower.



Hang the monitor on tower and your ready to go. (It is recommended that two people assist with the hanging of the monitor onto the tower.)



Monitor Mount

Enhance your Pop Up display with a floor stand monitor mount. The Spennare Monitor Mount stand fits perfectly as an integrated flat screen monitor holder for your Backwall or Table Top Pop Up. Or simply use it as traditional flat screen floor monitor stand.

Holds up to a 42" maximum monitor size or 60lbs.

● Pricing / Specifications

Price \$495

Max Dimension: 70.875"h 25"w x 14.75"d
 Weight: 25lbs.
 Material: Aluminum



Spennare monitor mount with 4x3 Flat VBurst frame & graphic (As Shown) \$1,760



Spennare monitor mount with 4x3 Flat VBurst Frame View



Spennare monitor mount with 2x2 Flat VBurst frame, graphic and table throw (As Shown) \$1,079

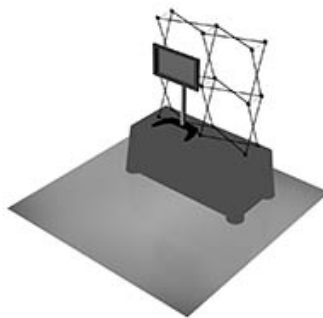

Spennare monitor mount with 2x2 Flat VBurst Frame View



Monitor not included.

Spennare monitor mount with 4x3 Curved VBurst frame & graphic (As Shown) \$1,744

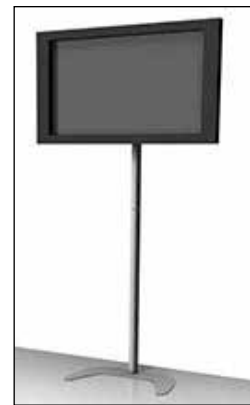

Spennare monitor mount holds up to a 42" maximum monitor size or 60lbs.



The Monitor Mount can be adjusted to a height of 70" and the pole is divisible for optimized handling, transportation and storage.

xpressions[®]

MONSTER MONITOR 8FT DISPLAY™

A Monster Monitor Requires A Monster Display.
As the rental and purchase price of monitors goes down their presence at tradeshow is increasing along with their size! Large-sized monitors are everywhere.

A monster monitor needs a monster display and Xpressions Monster Monitor 8ft Display is up to the challenge. Holds up to a 55" monitor (we've used a 60" with no problem!) Best part about this strong monitor display is that it's Xpressions... Up fast and down even faster and it's style matches your Xpressions display perfectly!

Pricing

- Xpressions Monster Monitor Tower with monitor mount and shelf \$1,219
 - Six 1x1 Flat Xpressions skin \$588
 - 1x2 Verticle Xpressions skin \$180
 - Total Kit Price \$1,987 each**
- (Suggested max size and weight for monitor tower is 55" and max weight is 70lbs.)

Monitor Tower has been tested with a monitor 60" at 75lbs. successfully.)

Total Weight: 40lbs.

- Display - 25lbs
- Monitor Mount - 10lbs
- Shelf - 5lbs

Dimensions:

- Tower - 24"d x 30"w x 88"h (open)
- 7"d x 5"w x 63"L (collapsed)
- Monitor Mount - 30" x 30" (open)
- Black Shelf - 28.5" x 12" (open)

Color: Black

Shipping Box Size: 10" x 10" x 66"

Hard Shipping Case Available

- Size: 70" x 16" x 14"
- Weight: 20lbs
- Price \$260



Shipping Case closed



Shipping Case open



Monitor not included.

Xpressions 8' display, monitor mount, shelf (hidden) & 7 Xpressions graphics - Price \$1,987



Easily attach the monitor mount to the display.



Hang the monitor on display and your ready to go. (It is recommended that two people assist with the hanging of the monitor onto the display.)

optimagfx.com

expand[®] Podium

The Expand Podium is a great communication station for your show, event or when recruiting. The podium comes with a black top, 4 shelves (for storage), skirting and hardware for graphic assembly and carry bag. The Expand Podium closes up into a case for easy transportaion.

NOTE: The case used in the Expand Podium is the same case offered with the Expand Linkwall kit. The price for the Podium itself is more because the case is discounted as part of the Linkwall kit package.



Expand Podium with top, four shelves and lambda graphics - Price \$950

Pricing

Price \$950

(price includes podium, top, 4 shelves and lambda graphic)

Podium Size

Closed: 39.5625"h x 28.75"w x 17.6875

Open: 39.5625"h x 48.8125"w x 23.625

Shipping Weight

40 lbs (Podium, top & shelves)

Podium Graphic Size

(apply supplied hardware for graphic installation)

Size: 33.43"h x 68.87"w

Call for availability of custom color Podium tops:

White, Oak, Birch, Aluminum

Below is a list of products and quantities that fit in the Expand PodiumCase:

(Note: All listed are the 33.5" wide versions.)

Expand QuickScreen1; 10 units

Expand QuickScreen 3; 7 units

Expand MediaScreen 1; 10 units

Expand MediaScreen 2; 6 units

Expand MediaScreen 3; 4 units

Expand MediaScreen 4; 7 units

Expand BannerStand; 10 units

DUO Hello

The DUO Hello is a shipping case that turns into a counter and holds 2 retractable bannerstands. This solution offers maximum exposure for your brand and an optimized work area for your sales people during presentations, training seminars, road shows, recruiting or internal events!

NOTE: The Duo Hello case is NOT A HARD SHIPPING CASE only a compact rolling travel case sturdy enough for typical airline checked baggage. If you need to ship the Duo Hello case UPS or FedEx use the provided cardboard carton.



DUO Hello case to counter and two The Set retractable banner stands Price \$1,225

Pricing

DUO Hello includes:

- 1 Case to Counter with Graphic Wrap \$540
- 2 The Set 32.25”w retractable banner stands with Microknit graphics at 90”h \$686

Total Price \$1,225

Specifications

DUO Hello Shipping Weight:

(2 banner stands and case to counter)
56lbs. (add 2 - 5 lbs. for box and packing)

The Set retractable banner stand:

Unit size:
32.25”w

Graphic size:

Live Area: 31.5” x 36” TO 90”
Final Size: 31.5” x 42” TO 96”

Case to Counter:

Unit Size:
Closed & Packed - 38”H x 12”D x 18.5”W
Set-Up - 34.25”H x 18.5”D x 37.25”W

Graphic Size:

Live Area: 30” Centered
Final Size: 100” x 34.6”

Accessories

Light

50 watt halogen; available in silver & black
Price \$59 each



Light Bag

Black canvas w/ handles; holds 2 lights
Price \$30 each



AVIATOR™

HANGING FABRIC STRUCTURES

Aviator™ Hanging Fabric Structures present your brand or convey your message fast, up high and from all directions. Available in exciting shapes and practical sizes to meet any trade show or event need. Constructed from the highest quality lightweight materials, the Aviator™ frame assembles with push button connectors. No tools are ever required. The structure is skinned with the very best tension fabric graphics! Superior fabrics, zippers and sewing techniques ensure that your display will bring many years of use. Our unmatched dye sublimation printing is guaranteed to make your images stand out on the show floor. Aviator™ is effective, adaptable, easy to set-up and affordable.

Aviator™ Hanging Circle is a trade show and event standard. The Circle is one of the most popular shapes and with good reason - it offers unparalleled 360 brand or message visibility

Pricing (Circle Hanging)

Size	Frame Price	Graphic Price	Kit Price
10' x 36"	\$565	\$1128	\$1693
10' x 42"	\$628	\$1320	\$1948

NOTE: Kit cost includes printed outside and unprinted white inside. Printed inside & opaque liner / blocker available. Call for quote.

Specifications

Shipping Box
26" x 49" x 9"

Frame Weight
10' x 36" 39lbs.
10' x 42" 41lbs.
(add 10 - 14lbs. for graphic and packing.)



Harness and Cables included.

For Rental options contact your Account Representative.



Aviator 10' x 42" Circle frame with graphic \$1948

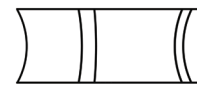

Front

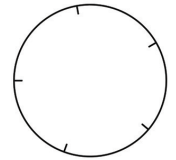

Top

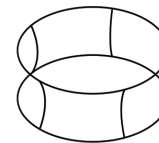

Isometric

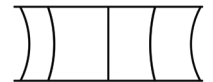

Side

Accessories

Carry Bag (black canvas)

Price \$24 Size: 12" x 12" x 60"



View of carry bag with frame in it.

Shipping case

Black w/ wheels \$180.00



Case Dimension

(Outside) ... 28"w x 52"h x 9.5"d
(Inside) 24"w x 48" h x 9"d

Aviator Rotating Motor (optional)

Price \$800.00
Dim: 9.5"w x 9.5"h x 3.5"d
Weight Capacity: 200 lbs
Rotation Speed: 2RPM

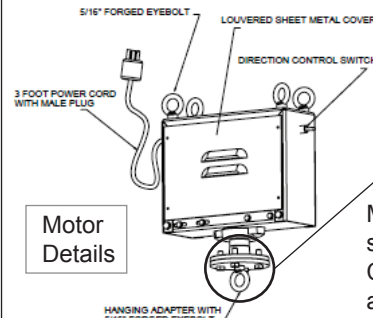

Motor Details

Motor attaches to Harness shown above. Cables from Harness attach to Aviator display.

AVIATOR™

HANGING FABRIC STRUCTURES

Aviator™ Hanging Fabric Structures present your brand or convey your message fast, up high and from all directions. Available in exciting shapes and practical sizes to meet any trade show or event need. Constructed from the highest quality lightweight materials, the Aviator™ frame assembles with push button connectors. No tools are ever required. The structure is skinned with the very best tension fabric graphics! Superior fabrics, zippers and sewing techniques ensure that your display will bring many years of use. Our unmatched dye sublimation printing is guaranteed to make your images stand out on the show floor. Aviator™ is effective, adaptable, easy to set-up and affordable.

Aviator™ Hanging Pinwheel is a departure from ordinary! The pinwheel draws everyone's attention with its curious curves, unique connection points and flowing movement.

Pricing (Pinwheel Hanging)

Size	Frame Price	Graphic Price	Kit Price
10' x 36"	\$945	\$1260	\$2205
10' x 48"	\$1055	\$1440	\$2495
12' x 48"	\$1175	\$1728	\$2903

NOTE: Kit cost includes printed outside and unprinted white inside. Printed inside & opaque liner / blocker available. Call for quote.

Specifications

Shipping Box
26" x 49" x 9"

Frame Weight
10' x 36" 40lbs.
10' x 48" 42lbs.
12' x 48" 46lbs.
(add 10 - 14lbs. for graphic and packing.)



Harness and Cables included.

For Rental options contact your Account Representative.



Aviator 10' x 48" Pinwheel frame with graphic \$2495



Front

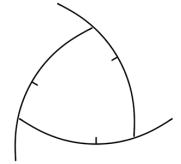

Top

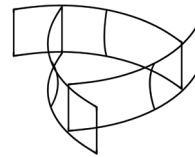

Isometric



Side

Accessories

Carry Bag (black canvas)

Price \$24 Size: 12" x 12" x 60"



View of carry bag with frame in it.

Shipping case

Black w/ wheels \$180.00



Case Dimension

(Outside) ... 28" w x 52" h x 9.5" d
(Inside) 24" w x 48" h x 9" d

Aviator Rotating Motor (optional)

Price \$800.00
Dim: 9.5" w x 9.5" h x 3.5" d
Weight Capacity: 200 lbs
Rotation Speed: 2RPM

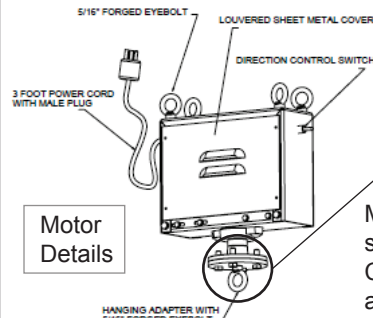

Motor Details

Motor attaches to Harness shown above. Cables from Harness attach to Aviator display.

AVIATOR™

HANGING FABRIC STRUCTURES

Aviator™ Hanging Fabric Structures present your brand or convey your message fast, up high and from all directions. Available in exciting shapes and practical sizes to meet any trade show or event need. Constructed from the highest quality lightweight materials, the Aviator™ frame assembles with push button connectors. No tools are ever required. The structure is skinned with the very best tension fabric graphics! Superior fabrics, zippers and sewing techniques ensure that your display will bring many years of use. Our unmatched dye sublimation printing is guaranteed to make your images stand out on the show floor. Aviator™ is effective, adaptable, easy to set-up and affordable.

Aviator™ Hanging Four-sided Rectangle stretches your message, whether it's the same message on each side or something different. Excellent for spaces that can benefit from two longer sides.

Pricing (Four-Sided Rectangle Hanging)

Size	Frame Price	Graphic Price	Kit Price
10' x 5' x 42"	\$976	\$1260	\$2236

NOTE: Kit cost includes printed outside and unprinted white inside. Printed inside & opaque liner / blocker available. Call for quote.

Specifications

Shipping Box
56" x 26" x 9"

Frame Weight
10' x 5' x 42" 49lbs.
(add 10 - 14lbs. for graphic and packing.)



Harness and Cables included.

For Rental options contact your Account Representative.



Aviator 10' x 5' x 42" Rectangle frame with graphic \$2236



Front

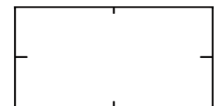

Top

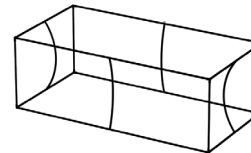

Isometric

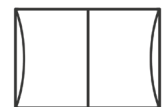

Side

Accessories

Carry Bag (black canvas)

Price \$24 Size: 12" x 12" x 60"



View of carry bag with frame in it.

Shipping case

Black w/ wheels \$180.00



Case Dimension

(Outside) ... 28"w x 52"h x 9.5"d
(Inside) 24"w x 48" h x 9"d

Aviator Rotating Motor (optional)

Price \$800.00
Dim: 9.5"w x 9.5"h x 3.5"d
Weight Capacity: 200 lbs
Rotation Speed: 2RPM

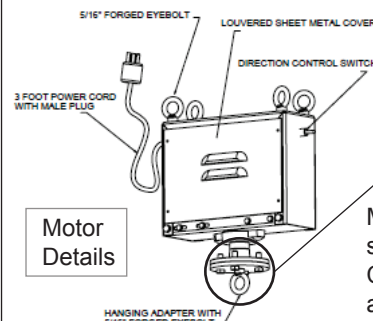

Motor Details

Motor attaches to Harness shown above. Cables from Harness attach to Aviator display.

AVIATOR™

HANGING FABRIC STRUCTURES

Aviator™ Hanging Fabric Structures present your brand or convey your message fast, up high and from all directions. Available in exciting shapes and practical sizes to meet any trade show or event need. Constructed from the highest quality lightweight materials, the Aviator™ frame assembles with push button connectors. No tools are ever required. The structure is skinned with the very best tension fabric graphics! Superior fabrics, zippers and sewing techniques ensure that your display will bring many years of use. Our unmatched dye sublimation printing is guaranteed to make your images stand out on the show floor. Aviator™ is effective, adaptable, easy to set-up and affordable.

Aviator™ Hanging Square provides the ideal visual billboard that reaches every corner of the event. The Square mimics the typical floor space creating a strong dominant presence.

Pricing (Square Hanging)

Size	Frame Price	Graphic Price	Kit Price
10' x 36"	\$744	\$1440	\$2184
10' x 42"	\$768	\$1680	\$2448

NOTE: Kit cost includes printed outside and unprinted white inside. Printed inside & opaque liner / blocker available. Call for quote.

Specifications

Shipping Box
56" x 26" x 9"

Frame Weight
10' x 36" 46lbs.
10' x 42" 48lbs.
(add 10 - 14lbs. for graphic and packing.)



Harness and Cables included.

For Rental options contact your Account Representative.



Aviator 10' x 42" Square frame with graphic \$2448



Front

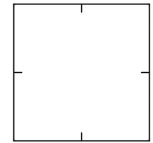

Top

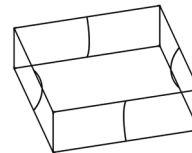

Isometric



Side

Accessories

Carry Bag (black canvas)

Price \$24 Size: 12" x 12" x 60"



View of carry bag with frame in it.

Shipping case

Black w/ wheels \$180.00



Case Dimension

(Outside) ... 28"w x 52"h x 9.5"d
(Inside) 24"w x 48" h x 9"d

Aviator Rotating Motor (optional)

Price \$800.00
Dim: 9.5"w x 9.5"h x 3.5"d
Weight Capacity: 200 lbs
Rotation Speed: 2RPM

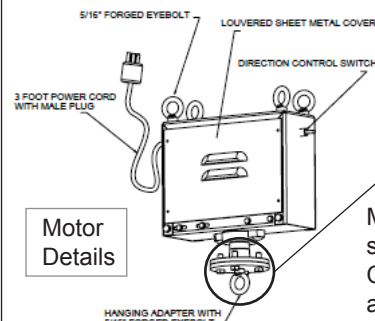

Motor Details

Motor attaches to Harness shown above. Cables from Harness attach to Aviator display.

AVIATOR™

HANGING FABRIC STRUCTURES

Aviator™ Hanging Fabric Structures present your brand or convey your message fast, up high and from all directions. Available in exciting shapes and practical sizes to meet any trade show or event need. Constructed from the highest quality lightweight materials, the Aviator™ frame assembles with push button connectors. No tools are ever required. The structure is skinned with the very best tension fabric graphics! Superior fabrics, zippers and sewing techniques ensure that your display will bring many years of use. Our unmatched dye sublimation printing is guaranteed to make your images stand out on the show floor. Aviator™ is effective, adaptable, easy to set-up and affordable.

Aviator™ Hanging Tapered Circle combines all the high impact of the Circle with an angled surface for better visibility from closer locations on the show floor.

Pricing (Tapered Circle Hanging)

Size	Frame Price	Graphic Price	Kit Price
10' x 36"	\$630	\$1356	\$1986
10' x 42"	\$700	\$1848	\$2548

NOTE: Kit cost includes printed outside and unprinted white inside. Printed inside & opaque liner / blocker available. Call for quote.

Specifications

Shipping Box
26" x 49" x 9"

Frame Weight
10' x 36" 40lbs.
10' x 42" 42lbs.
(add 10 - 14lbs. for graphic and packing.)



Harness and Cables included.

For Rental options contact your Account Representative.



Aviator 10' x 42" Tapered Circle frame with graphic \$2548

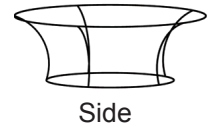
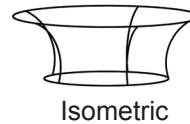
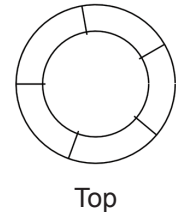
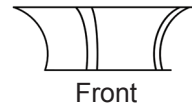

Accessories

Carry Bag (black canvas)

Price \$24 Size: 12" x 12" x 60"



View of carry bag with frame in it.

Shipping case

Black w/ wheels \$180.00



Case Dimension

(Outside) ... 28"w x 52"h x 9.5"d
(Inside) 24"w x 48" h x 9"d

Aviator Rotating Motor (optional)

Price \$800.00
Dim: 9.5"w x 9.5"h x 3.5"d
Weight Capacity: 200 lbs
Rotation Speed: 2RPM

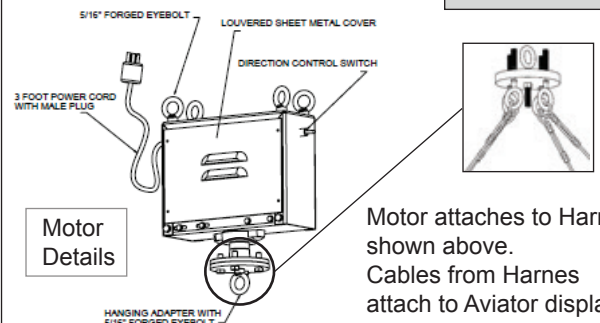

Motor Details

Motor attaches to Harness shown above. Cables from Harness attach to Aviator display.

AVIATOR™

HANGING FABRIC STRUCTURES

Aviator™ Hanging Fabric Structures present your brand or convey your message fast, up high and from all directions. Available in exciting shapes and practical sizes to meet any trade show or event need. Constructed from the highest quality lightweight materials, the Aviator™ frame assembles with push button connectors. No tools are ever required. The structure is skinned with the very best tension fabric graphics! Superior fabrics, zippers and sewing techniques ensure that your display will bring many years of use. Our unmatched dye sublimation printing is guaranteed to make your images stand out on the show floor. Aviator™ is effective, adaptable, easy to set-up and affordable.

Aviator™ Hanging Tapered Square combines all the qualities of the Square with an angled surface for better visibility from closer locations on the show floor. The Tapered Square remains one of the most popular choices for trade shows, special events and retail environments

Pricing (Tapered Square Hanging)

Size	Frame Price	Graphic Price	Kit Price
10' x 36"	\$908	\$1728	\$2636
10' x 42"	\$936	\$1976	\$2852

NOTE: Kit cost includes printed outside and unprinted white inside. Printed inside & opaque liner / blocker available. Call for quote.

Specifications

Shipping Box
56" x 26" x 9"

Frame Weight
10' x 36" 49lbs.
10' x 42" 50lbs.
(add 10 - 14lbs. for graphic and packing.)



Harness and Cables included.

For Rental options contact your Account Representative.



Aviator 10' x 42" Tapered Square frame with graphic \$2852

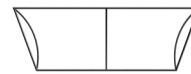

Front

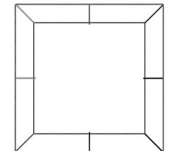

Top

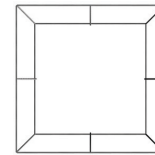

Isometric

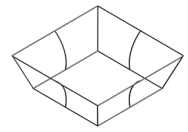

Side

Accessories

Carry Bag (black canvas)

Price \$24 Size: 12" x 12" x 60"



View of carry bag with frame in it.

Shipping case

Black w/ wheels \$180.00



Case Dimension

(Outside) ... 28"w x 52"h x 9.5"d
(Inside) 24"w x 48" h x 9"d

Aviator Rotating Motor (optional)

Price \$800.00
Dim: 9.5"w x 9.5"h x 3.5"d
Weight Capacity: 200 lbs
Rotation Speed: 2RPM

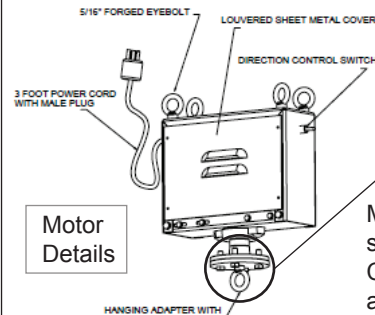

Motor Details

Motor attaches to Harness shown above. Cables from Harness attach to Aviator display.

AVIATOR™

HANGING FABRIC STRUCTURES

Aviator™ Hanging Fabric Structures present your brand or convey your message fast, up high and from all directions. Available in exciting shapes and practical sizes to meet any trade show or event need. Constructed from the highest quality lightweight materials, the Aviator™ frame assembles with push button connectors. No tools are ever required. The structure is skinned with the very best tension fabric graphics! Superior fabrics, zippers and sewing techniques ensure that your display will bring many years of use. Our unmatched dye sublimation printing is guaranteed to make your images stand out on the show floor. Aviator™ is effective, adaptable, easy to set-up and affordable.

Aviator™ Hanging Triangle offers the visual balance of three equal sides. The sharp angles of the triangle contrast with the typical square floor space providing drama and visual appeal.

Pricing (Triangle Hanging)

Size	Frame Price	Graphic Price	Kit Price
10' x 36"	\$612	\$1080	\$1692
10' x 42"	\$642	\$1470	\$2112

NOTE: Kit cost includes printed outside and unprinted white inside. Printed inside & opaque liner / blocker available. Call for quote.

Specifications

Shipping Box
56" x 26" x 9"

Frame Weight
10' x 36" 41lbs.
10' x 42" 43lbs.
(add 10 - 14lbs. for graphic and packing.)



Harness and Cables included.

For Rental options contact your Account Representative.

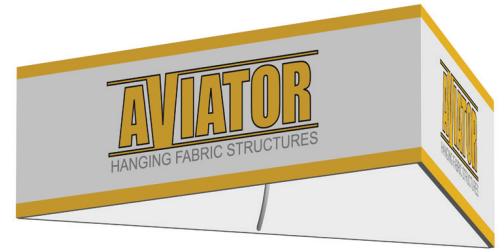

Aviator 10' x 42" Triangle frame with graphic \$2112



Front

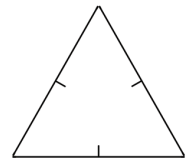

Top

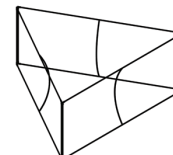

Isometric



Side

Accessories

Carry Bag (black canvas)

Price \$24 Size: 12" x 12" x 60"



View of carry bag with frame in it.

Shipping case

Black w/ wheels \$180.00

Case Dimension

(Outside) ... 28"w x 52"h x 9.5"d
(Inside) 24"w x 48" h x 9"d



Aviator Rotating Motor (optional)

Price \$800.00
Dim: 9.5"w x 9.5"h x 3.5"d
Weight Capacity: 200 lbs
Rotation Speed: 2RPM

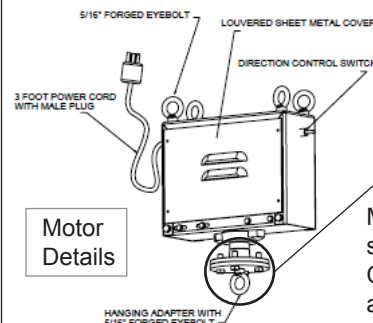

Motor Details

Motor attaches to Harness shown above. Cables from Harness attach to Aviator display.

Wind™ Table Top

The Aviator™ Table Top is a great solution with an upscale style. The black aluminum tube frame with push button assembly makes setting up quick and easy. All Aviator™ Table Top graphics are finished in the pillowcase style. Top quality dye sublimation and sturdy zippers bring the same fantastic Optima Aviator™ hanging sign graphics to these Table Tops. A hard shipping case comes included with every Aviator™ Table Top unit order.



Aviator TT Wind 79" w x 42.125" h
w/Kaleidoscope Select,
8' table throw & Light \$1,103

Pricing (includes graphic, unit, light & case)

Unit Size	Live Area	Print Size	Aviator TT Wind w/Kaleidoscope Select (Printed front only)
75" w x 43" h	59" w (up to 73" w at widest center point) x 36" h	79" w x 42.125" h	\$978

- Optional Blocker available for \$24.00
- Graphic Finishing - pillowcasing with zippers
- Double Sided graphics available. Call for a quote
- 8' table throw (as shown above) \$125

Units may be purchased without graphic \$684 each



Shipping Case (included)

5 Great shapes available - Call for more details.

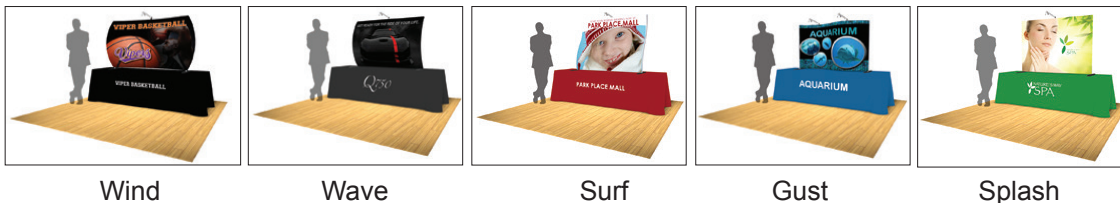

Wind

Wave

Surf

Gust

Splash

Specifications

Shipping Weight
Unit only 10.5 lbs.

Unit with Graphic 12 lbs.
Hard Case only 11 lbs.
Total ship weight 23 lbs.

Unit Color
Black

Foot Color
Black

Hard Case Dimension (included)
54.25" w x 12" d x 8" h

Unit Dimensions
(Open) 43" h x 75" w x 18.5" d (foot)

Accessories

Additional or Replacement Light
50 watt halogen w/clamp.....\$74 ea.
(available in black or silver)

Each unit includes one 50 watt halogen light. Additional and replacement lights available in Accessories below.



Light Bag
Black canvas w/ handles;
holds 2 lights.....\$30 ea.



Wave™ Table Top

The Aviator™ Table Top is a great solution with an upscale style. The black aluminum tube frame with push button assembly makes setting up quick and easy. All Aviator™ Table Top graphics are finished in the pillowcase style. Top quality dye sublimation and sturdy zippers bring the same fantastic Optima Aviator™ hanging sign graphics to these Table Tops. A hard shipping case comes included with every Aviator™ Table Top unit order.



**Aviator TT Wave 66" w x 45.5" h
w/Kaleidoscope Select,
8' table throw & Light \$1,103**

Pricing (includes graphic, unit, light & case)

Unit Size	Live Area	Print Size	Aviator TT Wave w/Kaleidoscope Select (Printed front only)
64" w x 41.5" h	60" w x 38.75" h	66" w x 45.5" h	\$978

- Optional Blocker available for \$22.00
- Graphic Finishing - pillowcasing with zippers
- Double Sided graphics available. Call for a quote
- 8' table throw (as shown above) \$125

Units may be purchased without graphic \$684 each



Shipping Case (included)

5 Great shapes available - Call for more details.

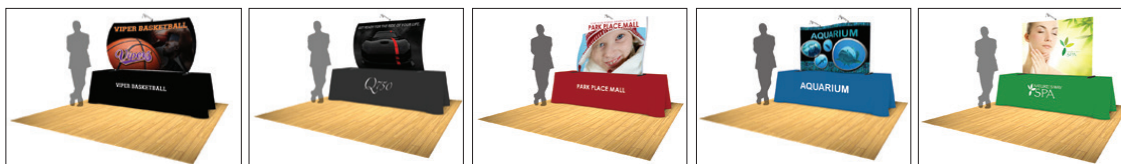

Wind

Wave

Surf

Gust

Splash

Specifications

Shipping Weight
Unit only 10 lbs.

Unit Color
Black

Unit with Graphic 12 lbs.
Hard Case only 11 lbs.
Total ship weight 23 lbs.

Foot Color
Black

Hard Case Dimension (included)
54.25" w x 12"d x 8"h

Unit Dimensions
(Open) 64" w x 41.5" h x 18.5" d (foot)

Accessories

Additional or Replacement Light
50 watt halogen w/clamp.....\$74 ea.
(available in black or silver)

Each unit includes one 50 watt halogen light. Additional and replacement lights available in Accessories below.



Light Bag
Black canvas w/ handles;
holds 2 lights.....\$30 ea.



Surf™ Table Top

The Aviator™ Table Top is a great solution with an upscale style. The black aluminum tube frame with push button assembly makes setting up quick and easy. All Aviator™ Table Top graphics are finished in the pillowcase style. Top quality dye sublimation and sturdy zippers bring the same fantastic Optima Aviator™ hanging sign graphics to these Table Tops. A hard shipping case comes included with every Aviator™ Table Top unit order.



Aviator TT Surf 65.8" w x 50.125" h
w/Kaleidoscope Select,
8' table throw & Light \$1,103

Pricing (includes graphic, unit, light & case)

Unit Size	Live Area	Print Size	Aviator TT Wave w/Kaleidoscope Select (Printed front only)
69" w x 49" h	61" w x 43.75" h	65.8125" w x 50.125" h	\$978

- Optional Blocker available for \$22.00
- Graphic Finishing - pillowcasing with zippers
- Double Sided graphics available. Call for a quote
- 8' table throw (as shown above) \$125

Units may be purchased without graphic \$684 each



Shipping Case (included)

5 Great shapes available - Call for more details.



Wind

Wave

Surf

Gust

Splash

Specifications

Shipping Weight
Unit only 14 lbs.

Unit Color
Black

Unit with Graphic 16 lbs.
Hard Case only 11 lbs.
Total ship weight 27 lbs.

Foot Color
Black

Hard Case Dimension (included)
54.25" w x 12"d x 8"h

Unit Dimensions
(Open) 69" w x 49" h x 18.5" d (foot)

Accessories

Additional or Replacement Light
50 watt halogen w/clamp.....\$74 ea.
(available in black or silver)

Each unit includes one 50 watt halogen light. Additional and replacement lights available in Accessories below.



Light Bag
Black canvas w/ handles;
holds 2 lights.....\$30 ea.



Gust™ Table Top

The Aviator™ Table Top is a great solution with an upscale style. The black aluminum tube frame with push button assembly makes setting up quick and easy. All Aviator™ Table Top graphics are finished in the pillowcase style. Top quality dye sublimation and sturdy zippers bring the same fantastic Optima Aviator™ hanging sign graphics to these Table Tops. A hard shipping case comes included with every Aviator™ Table Top unit order.

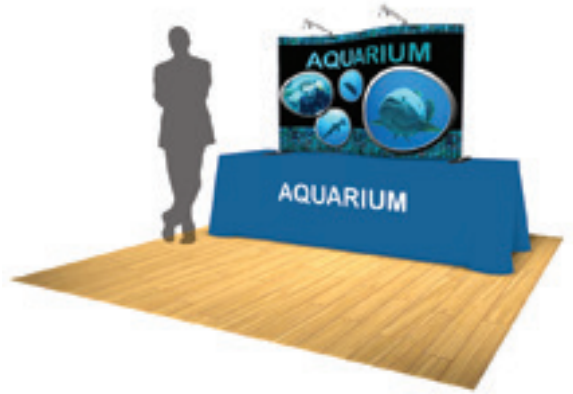

Aviator TT Gust 71.125" w x 45.8" h
w/Kaleidoscope Select,
8' table throw & 2 Lights \$1,103

Pricing (includes graphic, unit, light & case)

Unit Size	Live Area	Print Size	Aviator TT Wave w/Kaleidoscope Select (Printed front only)
72" w x 48.5" h	67" w x 42.5" h	71.125" w x 48.875" h	\$978

- Optional Blocker available for \$22.00
- Graphic Finishing - pillowcasing with zippers
- Double Sided graphics available. Call for a quote
- 8' table throw (as shown above) \$125

Units may be purchased without graphic \$684 each



Shipping Case (included)

5 Great shapes available - Call for more details.



Wind

Wave

Surf

Gust

Splash

Specifications

Shipping Weight
Unit only 14 lbs.

Unit Color
Black

Unit with Graphic 16 lbs.
Hard Case only 11 lbs.
Total ship weight 27 lbs.

Foot Color
Black

Hard Case Dimension (included)
54.25" w x 12" d x 8" h

Unit Dimensions
(Open) 72" w x 48.5" h x 18.5" d (foot)

Accessories

Additional or Replacement Light
50 watt halogen w/clamp.....\$74 ea.
(available in black or silver)

Each unit includes one 50 watt halogen light. Additional and replacement lights available in Accessories below.



Light Bag
Black canvas w/ handles;
holds 2 lights.....\$30 ea.



Splash™ Table Top

The Aviator™ Table Top is a great solution with an upscale style. The black aluminum tube frame with push button assembly makes setting up quick and easy. All Aviator™ Table Top graphics are finished in the pillowcase style. Top quality dye sublimation and sturdy zippers bring the same fantastic Optima Aviator™ hanging sign graphics to these Table Tops. A hard shipping case comes included with every Aviator™ Table Top unit order.



Aviator TT Splash 65.8125" w x 49" h w/Kaleidoscope Select, 8' tabel throw & Light \$1,103

Pricing (includes graphic, unit, light & case)

Unit Size	Live Area	Print Size	Aviator TT Wave w/Kaleidoscope Select (Printed front only)
72" w 49.75" h	61" w x 43" h	65.8125" w x 49.0625" h	\$978

- Optional Blocker available for \$22.00
- Graphic Finishing - pillowcasing with zippers
- Double Sided graphics available. Call for a quote
- 8' table throw (as shown above) \$125

Units may be purchased without graphic \$684 each



Shipping Case (included)

5 Great shapes available - Call for more details.



Wind

Wave

Surf

Gust

Splash

Specifications

Shipping Weight

Unit only 14 lbs.

Unit with Graphic 16 lbs.

Hard Case only 11 lbs.

Total ship weight 27 lbs.

Unit Color

Black

Foot Color

Black

Hard Case Dimension (included)

54.25" w x 12"d x 8"h

Unit Dimensions

(Open) 72" w 49.75" h x 18.5" d (foot)

Accessories

Additional or Replacement Light

50 watt halogen w/clamp.....\$74 ea. (available in black or silver)

Each unit includes one 50 watt halogen light. Additional and replacement lights available in Accessories below.



Light Bag

Black canvas w/ handles; holds 2 lights.....\$30 ea.



NAVIGATOR

TENSION FABRIC / TUBE STRUCTURES

10ft Backwall

Great-looking displays constructed in the United States of top-grade aluminum tube and pillowcase-style dye sub fabric graphics. Navigator displays are available in many different shapes for any space. Each custom frame is carefully measured and a graphic template is created specifically for that frame. Frames are set-up easily in minutes with the Quick-Connect tube frame system and pillowcase design graphics easily slip over and zip tight for a clean presentation. Lightweight, full-sized displays that will not break the budget! Navigator, a tremendous value with zero sacrifice to design and quality.



10ft Backwall Navigator frame, single sided graphic & shipping case w/packaging ... \$1,934

Pricing (includes graphic, frame & case)

- Single Sided Graphic \$1070
- 10ft backwall Navigator Frame \$664
- Hard Shipping Case & Packaging.... \$200
- TOTAL \$1,934**

Features

- Quick-Connect frame
- Kit solutions, everything you need for a 10'x10' or 10'x20' space
- Easy-to-follow instructions and labeled frame sections
- Heavy-duty zippers
- Top of the line Dye Sub Graphics
- Graphic templates for existing kit shapes
- Expert sewn pillow case graphics
- Custom frame options
- Lights available
- Durable hard case

Benefits

- Hassle-free
- Lightweight aluminum and fabric
- Frame and graphics made in the U.S.
- Packs into a hard case
- Precision frames - no awkward fits or pinched fingers
- Great-looking popular shapes or full custom

Specifications

Graphic size on Heavy Stretch fabric	Structure Specs
Front Size 94.25"h x 120.125"w	118"w x 92"h
Back Size 95.75"h x 112.625"w	

Shipping Weight

With hard shipping case: 52.75lbs

Without hard shipping case: 27.75lbs
(add 2-5 lbs for box and packaging)

PRINTED, SEWN, CUT, BENT and WELDED at Optima.

Accessories

Shipping case (with black wheels) & Packaging

Dims:
Outside: 28"w x 52"h x 9.5"d
Inside: 24"w x 48" h x 9"d
Price \$200

Graphic and Frame fit in one shipping case.



NAVIGATOR

TENSION FABRIC / TUBE STRUCTURES

10ft Concave

Great-looking displays constructed in the United States of top-grade aluminum tube and pillowcase-style dye sub fabric graphics. Navigator displays are available in many different shapes for any space. Each custom frame is carefully measured and a graphic template is created specifically for that frame. Frames are set-up easily in minutes with the Quick-Connect tube frame system and pillowcase design graphics easily slip over and zip tight for a clean presentation. Lightweight, full-sized displays that will not break the budget! Navigator, a tremendous value with zero sacrifice to design and quality.



10ft Concave Navigator frame,
single sided graphic
& shipping case ... \$1,939

Pricing (includes graphic, frame & case)

- Single Sided Graphic \$1,063
- 10ft Concave Navigator Frame \$676
- Hard Shipping Case & Packaging \$200
- TOTAL \$1,939**

- Double Sided Graphic \$1,540
- 10ft Concave Navigator Frame \$676
- Hard Shipping Case & Packaging \$200
- TOTAL \$2,416**

Benefits

- Hassle-free
- Lightweight aluminum and fabric
- Frame and graphics made in the U.S.
- Packs into a hard case
- Precision frames - no awkward fits or pinched fingers
- Great-looking popular shapes or full custom

Specifications

Graphic size on Heavy Stretch fabric	Structure Specs
Front Size 90.75”h x 118”w	115.5”w x 92”h
Back Size 90.75”h x 112”w	

Shipping Weight

With hard shipping case: 59.75lbs
 Without hard shipping case: 31.75lbs
 (add 2-5 lbs for box and packaging)

PRINTED, SEWN, CUT, BENT and WELDED at Optima.

Features

- Quick-Connect frame
- Kit solutions, everything you need for a 10’x10’ or 10’x20’ space
- Easy-to-follow instructions and labeled frame sections
- Heavy-duty zippers
- Top of the line Dye Sub Graphics
- Graphic templates for existing kit shapes
- Expert sewn pillow case graphics
- Custom frame options
- Lights available
- Durable hard case

Accessories

Shipping case (with black wheels) & Packaging

Dims:
 Outside: 28”w x 52”h x 9.5”d
 Inside: 24”w x 48” h x 9”d
 Price \$200

Graphic and Frame fit in one shipping case.



NAVIGATOR

TENSION FABRIC / TUBE STRUCTURES

10ft Wave

Great-looking displays constructed in the United States of top-grade aluminum tube and pillowcase-style dye sub fabric graphics. Navigator displays are available in many different shapes for any space. Each custom frame is carefully measured and a graphic template is created specifically for that frame. Frames are set-up easily in minutes with the Quick-Connect tube frame system and pillowcase design graphics easily slip over and zip tight for a clean presentation. Lightweight, full-sized displays that will not break the budget! Navigator, a tremendous value with zero sacrifice to design and quality.



10ft Wave Navigator frame,
single sided graphic
& shipping case ... \$1,992

Pricing (includes graphic, frame & case)

- Single Sided Graphic \$1,007
- 10ft Wave Navigator Frame \$785
- Hard Shipping Case & Packaging \$200
- TOTAL \$1,992**

- Double Sided Graphic \$1,460
- 10ft Wave Navigator Frame \$785
- Hard Shipping Case & Packaging \$200
- TOTAL \$2,445**

Benefits

- Hassle-free
- Lightweight aluminum and fabric
- Frame and graphics made in the U.S.
- Packs into a hard case
- Precision frames - no awkward fits or pinched fingers
- Great-looking popular shapes or full custom

Specifications

Graphic size on Heavy Stretch fabric	Structure Specs
Front Size 90.75"h x 114.5"w	118"w x 92"h
Back Size 90.75"h x 107.25"w	

Shipping Weight

With hard shipping case: 57.6lbs

Without hard shipping case: 32.6lbs
(add 2-5 lbs for box and packaging)

PRINTED, SEWN, CUT, BENT and WELDED at Optima.

Features

- Quick-Connect frame
- Kit solutions, everything you need for a 10'x10' or 10'x20' space
- Easy-to-follow instructions and labeled frame sections
- Heavy-duty zippers
- Top of the line Dye Sub Graphics
- Graphic templates for existing kit shapes
- Expert sewn pillow case graphics
- Custom frame options
- Lights available
- Durable hard case

Accessories

Shipping case (with black wheels) & Packaging

Dims:
Outside: 28"w x 52"h x 9.5"d
Inside: 24"w x 48" h x 9"d
Price \$200

*Graphic and Frame fit
in one shipping case.*



NAVIGATOR

TENSION FABRIC / TUBE STRUCTURES

10ft Serpentine

Great-looking displays constructed in the United States of top-grade aluminum tube and pillowcase-style dye sub fabric graphics. Navigator displays are available in many different shapes for any space. Each custom frame is carefully measured and a graphic template is created specifically for that frame. Frames are set-up easily in minutes with the Quick-Connect tube frame system and pillowcase design graphics easily slip over and zip tight for a clean presentation. Lightweight, full-sized displays that will not break the budget! Navigator, a tremendous value with zero sacrifice to design and quality.



10ft Serpentine Navigator frame,
single sided graphic
& shipping case ... \$1,932

Pricing (includes graphic, frame & case)

- Single Sided Graphic \$1,056
- 10ft Serpentine Navigator Frame \$676
- Hard Shipping Case & Packaging \$200
- TOTAL \$1,932**

- Double Sided Graphic \$1,526
- 10ft Serpentine Navigator Frame \$676
- Hard Shipping Case & Packaging \$200
- TOTAL \$2,402**

Benefits

- Hassle-free
- Lightweight aluminum and fabric
- Frame and graphics made in the U.S.
- Packs into a hard case
- Precision frames - no awkward fits or pinched fingers
- Great-looking popular shapes or full custom

Specifications

Graphic size on Heavy Stretch fabric	Structure Specs
Front Size 91.25”h x 122”w	119”w x 92”h
Back Size 91.25”h x 114”w	

Shipping Weight

With hard shipping case: 60lbs
 Without hard shipping case: 35lbs
 (add 2-5 lbs for box and packaging)

PRINTED, SEWN, CUT, BENT and WELDED at Optima.

Features

- Quick-Connect frame
- Kit solutions, everything you need for a 10’x10’ or 10’x20’ space
- Easy-to-follow instructions and labeled frame sections
- Heavy-duty zippers
- Top of the line Dye Sub Graphics
- Graphic templates for existing kit shapes
- Expert sewn pillow case graphics
- Custom frame options
- Lights available
- Durable hard case

Accessories

Shipping case (with black wheels) & Packaging

Dims:
 Outside: 28”w x 52”h x 9.5”d
 Inside: 24”w x 48” h x 9”d
 Price \$200



Graphic and Frame fit in one shipping case.

NAVIGATOR

TENSION FABRIC / TUBE STRUCTURES

20ft Serpentine

Great-looking displays constructed in the United States of top-grade aluminum tube and pillowcase-style dye sub fabric graphics. Navigator displays are available in many different shapes for any space. Each custom frame is carefully measured and a graphic template is created specifically for that frame. Frames are set-up easily in minutes with the Quick-Connect tube frame system and pillowcase design graphics easily slip over and zip tight for a clean presentation. Lightweight, full-sized displays that will not break the budget! Navigator, a tremendous value with zero sacrifice to design and quality.



20ft Serpentine Navigator frame,
single sided graphic
& shipping case ... \$3,502

Pricing (includes graphic, frame & case)

- Single Sided Graphic \$2,219
- 20ft Serpentine Navigator Frame \$1,083
- Hard Shipping Case & Packaging \$200
- TOTAL \$3,502**

- Double Sided Graphic \$3,065
- 20ft Serpentine Navigator Frame \$1,083
- Hard Shipping Case & Packaging \$200
- TOTAL \$4,348**

Benefits

- Hassle-free
- Lightweight aluminum and fabric
- Frame and graphics made in the U.S.
- Packs into a hard case
- Precision frames - no awkward fits or pinched fingers
- Great-looking popular shapes or full custom

Specifications

Graphic size on Heavy Stretch fabric	Structure Specs
Front Size 92”h x 227”w	234”w x 92”h
Back Size 92”h x 221”w	

Shipping Weight

With hard shipping case: 81lbs
Without hard shipping case: 56lbs
(add 2-5 lbs for box and packaging)

PRINTED, SEWN, CUT, BENT and WELDED at Optima.

Features

- Quick-Connect frame
- Kit solutions, everything you need for a 10’x10’ or 10’x20’ space
- Easy-to-follow instructions and labeled frame sections
- Heavy-duty zippers
- Top of the line Dye Sub Graphics
- Graphic templates for existing kit shapes
- Expert sewn pillow case graphics
- Custom frame options
- Lights available
- Durable hard case

Accessories

Shipping case (with black wheels) & Packaging

Dims:
Outside: 28”w x 52”h x 9.5”d
Inside: 24”w x 48” h x 9”d
Price \$200

Graphic and Frame fit in one shipping case.



NAVIGATOR

TENSION FABRIC / TUBE STRUCTURES

Single Radial Top

Great-looking displays constructed in the United States of top-grade aluminum tube and pillowcase-style dye sub fabric graphics. Navigator displays are available in many different shapes for any space. Each custom frame is carefully measured and a graphic template is created specifically for that frame. Frames are set-up easily in minutes with the Quick-Connect tube frame system and pillowcase design graphics easily slip over and zip tight for a clean presentation. Lightweight, full-sized displays that will not break the budget! Navigator, a tremendous value with zero sacrifice to design and quality.



Single Radial Top Navigator frame, single sided graphic & shipping case ... \$845

Pricing (includes graphic, frame & case)

- Single Sided Graphic \$282
- Single Radial Top Navigator Frame \$363
- Hard Shipping Case & Packaging \$200
- TOTAL \$845**

- Double Sided Graphic \$403
- Single Radial Top Navigator Frame ... \$363
- Hard Shipping Case & Packaging \$200
- TOTAL \$966**

Benefits

- Hassle-free
- Lightweight aluminum and fabric
- Frame and graphics made in the U.S.
- Packs into a hard case
- Precision frames - no awkward fits or pinched fingers
- Great-looking popular shapes or full custom

Specifications

Graphic size on Heavy Stretch fabric	Structure Specs
Front Size 83”h x 34.25”w	34.5”w x 83.75”h
Back Size 83”h x 34.25”w	

Shipping Weight

With hard shipping case: 48.75lbs
 Without hard shipping case: 23.75lbs
 (add 2-5 lbs for box and packaging)

PRINTED, SEWN, CUT, BENT and WELDED at Optima.

Features

- Quick-Connect frame
- Kit solutions, everything you need for a 10’x10’ or 10’x20’ space
- Easy-to-follow instructions and labeled frame sections
- Heavy-duty zippers
- Top of the line Dye Sub Graphics
- Graphic templates for existing kit shapes
- Expert sewn pillow case graphics
- Custom frame options
- Lights available
- Durable hard case

Accessories

Shipping case (with black wheels) & Packaging

Dims:
 Outside: 28”w x 52”h x 9.5”d
 Inside: 24”w x 48” h x 9”d
 Price \$200

Graphic and Frame fit in one shipping case.



NAVIGATOR

TENSION FABRIC / TUBE STRUCTURES

Double Radial Top

Great-looking displays constructed in the United States of top-grade aluminum tube and pillowcase-style dye sub fabric graphics. Navigator displays are available in many different shapes for any space. Each custom frame is carefully measured and a graphic template is created specifically for that frame. Frames are set-up easily in minutes with the Quick-Connect tube frame system and pillowcase design graphics easily slip over and zip tight for a clean presentation. Lightweight, full-sized displays that will not break the budget! Navigator, a tremendous value with zero sacrifice to design and quality.



Double Radial Top Navigator frame, single sided graphic & shipping case ... \$1,226

Pricing (includes graphic, frame & case)

- Single Sided Graphic (Face Only) \$276
- Double Radial Top Navigator Frame \$578
- Hard Shipping Case & Packaging \$200
- TOTAL \$1,054**

- Single Sided Graphic (Printed top & sides) \$448
- Double Radial Top Navigator Frame \$578
- Hard Shipping Case & Packaging \$200
- TOTAL \$1,226**

- Double Sided Graphic (Face & Back Only) .. \$461
- Double Radial Top Navigator Frame \$578
- Hard Shipping Case & Packaging \$200
- TOTAL \$1,239**

- Double Sided Graphic (Printed top & sides)..... \$548
- Double Radial Top Navigator Frame \$578
- Hard Shipping Case & Packaging \$200
- TOTAL \$1,326**

Features

- Quick-Connect frame
- Kit solutions, everything you need for a 10'x10' or 10'x20' space
- Easy-to-follow instructions and labeled frame sections
- Heavy-duty zippers
- Top of the line Dye Sub Graphics
- Graphic templates for existing kit shapes
- Expert sewn pillow case graphics
- Custom frame options
- Lights available
- Durable hard case

Specifications

Graphic size on Heavy Stretch fabric	Structure Specs
Single Size 83”h x 34.25”w	34.5”w x 83.75”h
Double Size 83”h x 35.25”w	
Side & Top Size 192.5”h x 13.75”w	

Shipping Weight

With hard shipping case: 51.5lbs
Without hard shipping case: 26.5lbs
(add 2-5 lbs for box and packaging)

PRINTED, SEWN, CUT, BENT and WELDED at Optima.

Accessories

Shipping case (with black wheels) & Packaging

Dims:
Outside: 28”w x 52”h x 9.5”d
Inside: 24”w x 48” h x 9”d
Price \$200



Graphic and Frame fit in one shipping case.

NAVIGATOR

TENSION FABRIC / TUBE STRUCTURES

Ribbon

Great-looking displays constructed in the United States of top-grade aluminum tube and pillowcase-style dye sub fabric graphics. Navigator displays are available in many different shapes for any space. Each custom frame is carefully measured and a graphic template is created specifically for that frame. Frames are set-up easily in minutes with the Quick-Connect tube frame system and pillowcase design graphics easily slip over and zip tight for a clean presentation. Lightweight, full-sized displays that will not break the budget! Navigator, a tremendous value with zero sacrifice to design and quality.



Ribbon Navigator frame,
single sided graphic
& shipping case ... \$1,051

Pricing (includes graphic, frame & case)

- Single Sided Graphic \$467
- Ribbon Navigator Frame \$384
- Hard Shipping Case & Packaging \$200
- TOTAL \$1,051**

Benefits

- Hassle-free
- Lightweight aluminum and fabric
- Frame and graphics made in the U.S.
- Packs into a hard case
- Precision frames - no awkward fits or pinched fingers
- Great-looking popular shapes or full custom

Specifications

Graphic size on Heavy Stretch fabric	Structure Specs
Front Size 140.875”h x 38”w	92”w x 34”h
Back Size 141.875”h x 30”w	

Shipping Weight

With hard shipping case: 39lbs
Without hard shipping case: 14lbs
(add 2-5 lbs for box and packaging)

PRINTED, SEWN, CUT, BENT and WELDED at Optima.

Features

- Quick-Connect frame
- Kit solutions, everything you need for a 10’x10’ or 10’x20’ space
- Easy-to-follow instructions and labeled frame sections
- Heavy-duty zippers
- Top of the line Dye Sub Graphics
- Graphic templates for existing kit shapes
- Expert sewn pillow case graphics
- Custom frame options
- Lights available
- Durable hard case

Accessories

Shipping case (with black wheels) & Packaging

Dims:
Outside: 28”w x 52”h x 9.5”d
Inside: 24”w x 48” h x 9”d
Price \$200

Graphic and Frame fit in one shipping case.



PRELIMINARY PRICING

Double Radial Top w/iPad Station

Tension Fabric /
Tube Structures

NAVIGATOR

TENSION FABRIC / TUBE STRUCTURES

Great-looking displays constructed in the United States of top-grade aluminum tube and pillowcase-style dye sub fabric graphics. Navigator displays are available in many different shapes for any space. Each custom frame is carefully measured and a graphic template is created specifically for that frame. Frames are set-up easily in minutes with the Quick-Connect tube frame system and pillowcase design graphics easily slip over and zip tight for a clean presentation. Lightweight, full-sized displays that will not break the budget! Navigator, a tremendous value with zero sacrifice to design and quality.



Double Radial Top frame, single sided graphic, iPad stations (2) & shipping case \$1,731

Pricing (includes graphic, frame & case)

- Single Sided Graphic (Face Only) \$276
- Double Radial Top Navigator Frame \$578
- iPad Station (stand alone) \$290
- Hard Shipping Case & Packaging \$200
- TOTAL \$1,344**

- Single Sided Graphic (Printed top & sides) \$448
- Double Radial Top Navigator Frame \$578
- iPad Station (stand alone) \$290
- Hard Shipping Case & Packaging \$200
- TOTAL \$1,516**

- Double Sided Graphic (Face & Back Only) \$461
- Double Radial Top Navigator Frame \$578
- 2 iPad Stations (stand alone) \$405
- Hard Shipping Case & Packaging \$200
- TOTAL \$1,644**

- Double Sided Graphic (Printed top & sides)..... \$548
- Double Radial Top Navigator Frame \$578
- 2 iPad Stations (stand alone) \$405
- Hard Shipping Case & Packaging \$200
- TOTAL \$1,731**

Specifications

Graphic size on Heavy Stretch fabric Structure Specs

Single Size 83”h x 34.25”w 34.5”w x 83.75”h
 Double Size 83”h x 34.25”w
 Side & Top Size 192.5”h x 13.75”w

Shipping Weight

With hard shipping case: 51.5lbs
 Without hard shipping case: 26lbs
 (add 2-5 lbs for box and packaging)

PRINTED, SEWN, CUT, BENT and WELDED at Optima.

Features

- Quick-Connect frame
- Kit solutions, everything you need for a 10x10? or 10x20? space
- Easy-to-follow instructions and labeled frame sections
- Heavy-duty zippers
- Top-of-the-line Dye Sub Graphics
- Graphic templates for existing kit shapes
- Expert Sewn Pillow Case Graphics
- Custom frame options
- Lights available
- Durable hard case

Accessories

Shipping case (with black wheels) & Packaging

Dims:
 Outside: 28”w x 52”h x 9.5”d
 Inside: 24”w x 48” h x 9”d
 Price \$200



Graphic iPad stand and Frame fit in one shipping case.

NAVIGATOR

TENSION FABRIC / TUBE STRUCTURES

Great-looking displays constructed in the United States of top-grade aluminum tube and pillowcase-style dye sub fabric graphics. Navigator displays are available in many different shapes for any space. Each custom frame is carefully measured and a graphic template is created specifically for that frame. Frames are set-up easily in minutes with the Quick-Connect tube frame system and pillowcase design graphics easily slip over and zip tight for a clean presentation. Lightweight, full-sized displays that will not break the budget! Navigator, a tremendous value with zero sacrifice to design and quality.

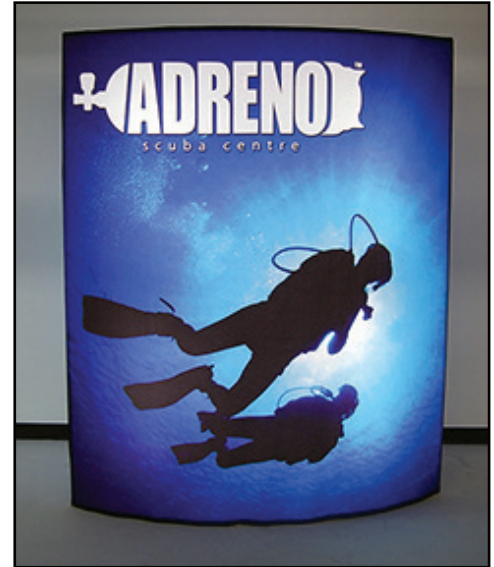

Navigator Ellipse backlit frame, double sided graphic & shipping case ... \$2,108

Pricing (includes graphic, frame & case)

Navigator Ellipse Backlit Frame \$925

Single Sided Backlit Graphic \$750

Double Sided Backlit Graphic \$1,005



Frame View



Side View



Package View

Navigator Tension Fabric/Tube Structures require a 7 - 10 day lead time.

Specifications

Graphic

Front & Back: 93.5"h x 82.125"w
Top: 26.5"h x 74.75"w

Structure Specs

92"h x 75"w x 24"d

Shipping Weight

67lbs
(frame and graphics in shipping case)

Accessories

Shipping case (with black wheels) & Packaging

Dims:
Outside: 28"w x 52"h x 9.5"d
Inside: 24"w x 48" h x 9"d
Price \$200



Graphic and Frame fit in one shipping case.

PRINTED, SEWN, CUT, BENT and WELDED at Optima.

NAVIGATOR

TENSION FABRIC / TUBE STRUCTURES

20ft w/Endcaps & Backlit Counter

Great-looking displays constructed in the United States of top-grade aluminum tube and pillowcase-style dye sub fabric graphics. Navigator displays are available in many different shapes for any space. Each custom frame is carefully measured and a graphic template is created specifically for that frame. Frames are set-up easily in minutes with the Quick-Connect tube frame system and pillowcase design graphics easily slip over and zip tight for a clean presentation. Lightweight, full-sized displays that will not break the budget! Navigator, a tremendous value with zero sacrifice to design and quality.



Navigator 20ft w/endcaps &
Backlit counter \$9,111

Pricing (includes graphic, frames & cases)

Basic Kit

3 - 6ft Concave / Convex frames & graphics ...	\$3,729
2 - Endcap frames and graphics	\$3,130
2 - Endcap Lights	\$192
1 - Backlit counter frame, top & graphics	\$1,460
3 - Flat Pack Cases for shipping	\$600
Total	\$9,111

Replacement Graphic Costs:

Single sided frame graphic	\$678 ea
Double Sided End cap graphic	\$510 ea
Counter graphic	\$1080 ea

Specifications

Graphic

6ft Concave / Convex:
 Front 91.5"h x 82.25"w
 Back 91.5"h x 75.5"w
 End caps:
 Outside 89.5"h x 70"w
 Inside 89.5"h x 60.625"w
 Counter:
Outer Portion
 Outside 39"h x 116.25"w
 Inside 39"h x 53"w
Backlit Portion
 Front 42.25"h x 43.75"w
 Back 39.375"h x 37.25"w

Shipping Weight

With 3 shipping cases: 245lbs total

Structure Specs

6ft Concave / Convex:
 80"w x 92"h
 End caps:
 24"w x 92"h x 24"d
 Counter:
 48"w x 42"h x 24"d

PRINTED, SEWN, CUT, BENT and WELDED at Optima.

Navigator Tension Fabric/Tube Structures require a 7 - 10 day lead time.

Optional Kit with Backlit Ellipse center backwall:

2 - 6ft Concave / Convex frames and graphics	\$2,486
1 - 6ft Backlit Ellipse frame and single sided graphic	\$1,675
2 - Endcap frames and graphics	\$3,130
2 - Endcap Lights	\$192
1 - Backlit counter frame, top & graphics	\$1,460
4 - Flat Pack Cases for shipping	\$800
Total	\$9,743

*If you want a stand alone backlit Navigator kit see page **HP-10** for the **Navigator Backlit Ellipse** wholesale price page.*

Accessories

Shipping case (with black wheels) & Packaging

Dims:
 Outside: 28"w x 52"h x 9.5"d
 Inside: 24"w x 48" h x 9"d
 Price \$200

Graphic and Frame fit in three shipping cases.





AURA™ is a great backlit solution for any environment. Stable and stylish free-standing aluminum extrusion frame fits in perfectly with any existing display. Add one or multiple AURA™ standing lightboxes to 10x10, 10x20 or island trade show spaces. The AURA™ is perfect for permanent installations and portable enough for easy transport in trade show applications. The round sides of this vertical frame have a far more finished and purposeful shape than typical exposed frames. Universal appeal of the frame is eclipsed by the stunning double sided backlit fabric graphics. The brilliance of Trifab dye sublimated graphics is second to none. The deep saturation and expanded pigment range of this process and material combo brings your image to life. Backlighting from the AURA™ lightbox brings out the brilliant color and fine detail of your high-quality images. Photos, text and colorful design elements all benefit from Dye-Sublimated backlit Trifab graphics. The optional rigid graphic header can be printed with a full image on both sides. The header makes a great topper that enhances your message. Create remarkable displays within 10', 20' inlines or larger island displays.

Easy change-out of the fabric, so easy that you could have a new message every day of the show! SEG (silicone edge graphics) means message updates ship to your destination in an envelope.

AURA™ 2472

- Double sided standing light box
- Frame (w/ 4 lights) \$708
- Graphics (2) \$168
- Total Price \$876**
- (cardboard shipping container included)

Header graphic available

Dimensions

Open: 24" w x 72" h
 Collapsed: 48.25" w x 7.5" d x 24.75" d



AURA™ 4272

- Double sided standing light box
- Frame (w/ 4 lights) \$737
- Graphics (2) \$320
- Total Price \$1,057**
- (cardboard shipping container included)

Header graphic available

Dimensions

Open: 42" w x 72" h
 Collapsed: 48.25" w x 7.5" d x 24.75" d



AURA™ 4886

- Double sided standing light box
- Frame (w/ 4 lights) \$738
- Graphics (2) \$458
- Optional Header Graphic \$61
- Total Price \$1,257**
- (cardboard shipping container included)

Dimensions

Open: 48" w x 86" h
 Collapsed: 48.25" w x 7.5" d x 24.75" d



Shown with optional Header graphic

Header Graphics - Print Process: Print-on-it or Lambda on 1/4" black or white sintra. (Price below based on double sided direct print to sintra.)

AURA™ 2472

Size: 18" w x 10" h \$39ea

AURA™ 4272

Size: 32" w x 10" h \$54ea

AURA™ 4886

Size: 39" w x 10" h \$61ea

Frame Schematics:

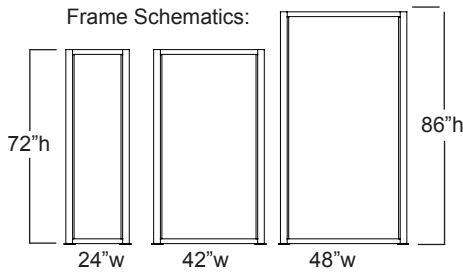

Hex key tool supplied for frame assembly.



AURA unit shown broken down and packed in supplied cardboard shipping carton.

Specifications

Main Graphic

Print Process: Dyesub / Material: Trifab

AURA™ 2472

Final Size: 19.4235" w x 69.3124" h
 Live Area: 18.4375" w x 68.25" h

AURA™ 4272

Final Size: 36.9374" w x 69.3124" h
 Live Area: 35.875" w x 68.25" h

AURA™ 4886

Final Size: 44.0485" w x 83.2985" h
 Live Area: 43.0625" w x 82.3125" h

Lights (qty. 4)

4-34.5" long T5 Fluorescent lights come with each frame and are included in the total price.

Additional Frame Dimensions

- Frame is 5" deep x sizes mentioned above.
- Feet are 22" long and extend 8.5" front and back of frame.

Weights (includes graphic, lights & frame)

- AURA™ 2472**
In carton ... 56lbs. / In case ... 71lbs.
- AURA™ 4272**
In carton ... 60lbs. / In case ... 75lbs.
- AURA™ 4886**
In carton ... 66lbs. / In case ... 81lbs.

Accessories



Side Panel Clamp
 Price \$15 each
 Size: 1.5" w x 1.5" h
 Color: Silver

Optional Hard Shipping Case

(Black w/ wheels)
 Price \$180.00
 Wt (empty) 25lbs.

Dimension:

(Outside) 28" w x 52" h x 9.5" d
 (Inside) 24" w x 48" h x 9" d

Cardboard Shipping Carton

Wt. (empty) 10lbs.
 48.25" w x 7.5" d x 24.75" d



Swap cardboard shipping carton for hard shipping case for \$175.

optimagfx.com

INFINITY™

EXTRUSION WALL SYSTEM

The INFINITY is a wall mounted aluminum extrusion frame system. Featuring taut Dye Sublimated SEG Fabric Graphics. The Fabric Graphics utilize the SEG (Silicone Edged Graphics) finishing system. INFINITY provides a slimmer lighter wall mounting system that is barely visible. Many other extrusion frame systems are too heavy for wall mounted applications. With INFINITY the taut SEG graphics flow directly from edge to edge with only the smallest of finished aluminum frame exposed. Opportunities for repeat business through contracted change out programs can strengthen your company's relationship while expanding your services!

What is SEG?

SEG finishing involves sewing silicone strips around the perimeter of the graphic. The graphic edge inserts into the groove on the perimeter of the frame to create a taut, flat display with a neatly finished corner.

Pricing

Parts / Accessories	Weight	Cost
Extrusion	0.25 lbs per foot	\$4.25 per linear foot
Corner Bracket	0.10 lbs each	\$3.85 each
Lateral Joint	0.3 lbs each	\$15.00 each
Hangers	0.05 lbs each	\$2.90 each
Kaleidoscope Select 4 color SEG* fabric graphic	N/A	\$9.00 per sqft
Colossus 8 color SEG* fabric graphic	N/A	\$9.00 per sqft

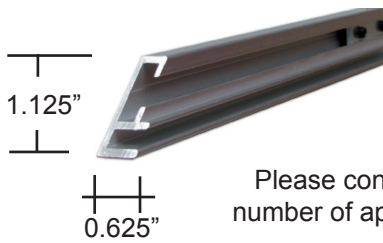

Extrusion comes in a maximum length of 13 feet. It is recommended that pieces do not exceed 9 feet to avoid additional freight charges.

Please consider individual piece lengths and number of appropriate connectors when quoting.

4/5/2010



Infinity frames mounted to wall with SEG graphic.

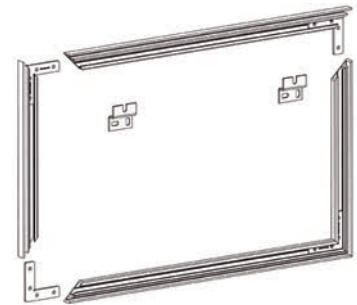

Frame assembly.



Infinity frame mounted to wall with SEG graphic.

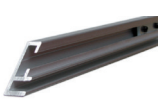

Extrusion



Corner Bracket



Lateral Joint

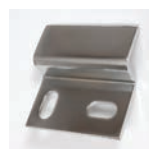

Hanging Bracket **



3 mm Allen Wrench included with purchase of any frame.

**It is recommended that a hanging bracket be used every five feet for extrusion frames exceeding 10 ft. For greater stability secure frames to wall using hanging brackets every five feet on sides and bottom.

NOUVEAU™

Fabric Graphic Display System

The Nouveau is an indoor aluminum extrusion frame system. Graphics for the Nouveau use the Silicone Edged Graphic system (SEG) of sewing silicone strips (welting) around the perimeter of the graphic. The graphic edge inserts into the groove on the perimeter of the frame to create a taut, flat display with a neatly finished corner.

What is SEG?

SEG finishing involves sewing silicone strips around the perimeter of the graphic. The graphic edge inserts into the groove on the perimeter of the frame to create a taut, flat display with a neatly finished corner.

NOTE: It is recommended that a support beam be included every 5 feet for extrusion frames exceeding 10 feet.

Pricing

Parts / Accessories	Weight	Cost
Extrusion	0.5 lbs per foot	\$6.75 per linear foot
Totem	1.65 lbs. per foot	\$17.25 per linear foot
Corner Brace	0.2 lbs each	\$10.00 each
Lateral Joint	0.3 lbs each	\$15.00 each
Lateral Foot	4.5 lbs each	\$54.00 each
Round Base	7.5 lbs each	\$54.00 each
Horizontal Foot	1 lb each	\$43.00 each
Wall Hanging Bracket	0.2 lbs each	\$13.00 each
Flower Base	4.5 lbs each	\$54.00 each
16" Peanut Base	2.8 lbs each	\$54.00 each
23" Peanut Base	5.6 lbs each	\$54.00 each
Narrow Angle Bracket	0.2 lbs each	\$14.50 each
Wide Angle Bracket	0.2 lbs each	\$14.50 each
Silicone Strip	0.05 lbs per foot	N/A
Base Fastener	0.6 lbs each	\$25.20 each
End Cap	0.1 lbs each	\$11.00 each
Linking Kit	N/A	\$7.25 each
Kaleidoscope Select 4 color SEG fabric graphic	N/A	\$9.00 per sqft
Colossus 8 color SEG fabric graphic	N/A	\$9.00 per sqft



20' wide Nouveau frame mounted to a wall w/SEG graphic. \$2,200 (as shown)

12.5"h x 14"w x .25 thick	SIZES
11.815" diameter x .25"thick	
15.75"w x 2"h x .44"thick	



10' wide Nouveau self standing frame w/SEG graphic and Lateral Feet.

Price ...\$1,300 (as shown)

NOUVEAU™

Fabric Graphic Display System

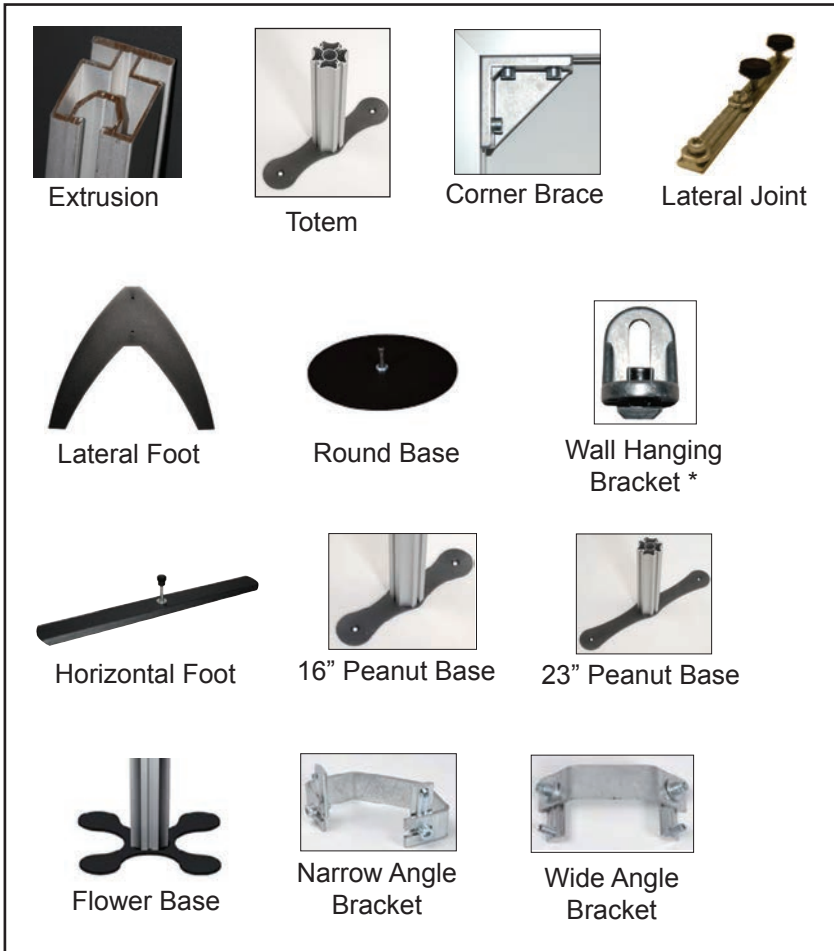

* Screws to attach brackets to walls are not provided.

Nouveau Tools: (Included at no extra cost)

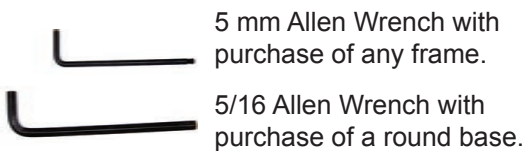

Available at extra cost:



Lighting Adapters:

Required when using lights with a Nouvea system.



One light adapter.
\$14.50 ea



Two light adapter.
\$17.00 ea

Lighting:

LED Wall Washer



\$88.00 ea

150/200 Watt Light



150w - \$42.00 ea
200w - \$68.00 ea

50 Watt Perf



\$59.00 ea

NOUVEAU™

Fabric Graphic Display System

Trade Show Kits

Nouveau 8' Kit

Item	Price
Frame	\$405
Graphic	\$586
Round Bases (2)	\$108
Graphic Case	\$175

Total \$1,274 (As Shown)

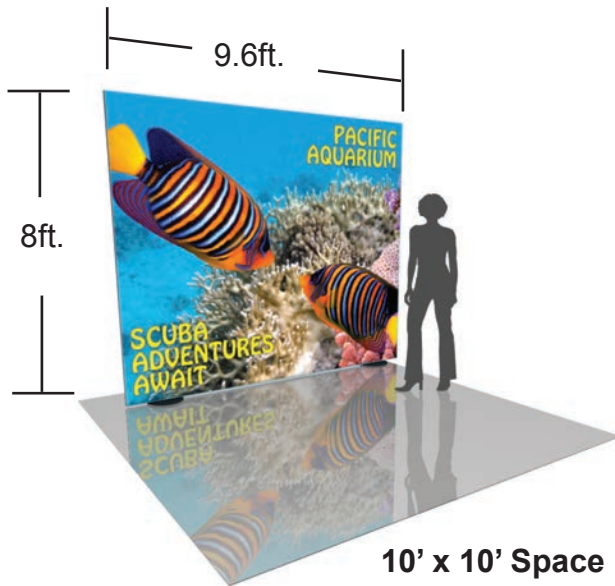
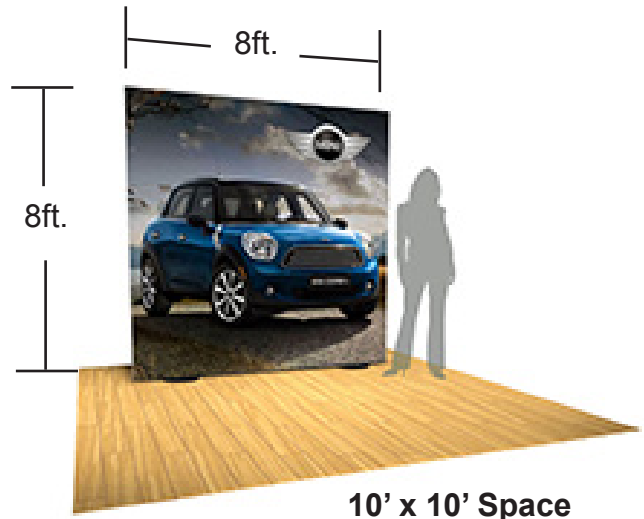

Nouveau 10' Kit

Item	Price
Frame	\$456
Graphic	\$702
Round Bases (2)	\$108
Graphic Case	\$175

Total \$1,441 (As Shown)

Nouveau 20' Kit

Item	Price
Frame	\$825
Graphic	\$1,428
Round Bases (4)	\$216
Graphic Case	\$175

Total \$2,644 (As Shown)

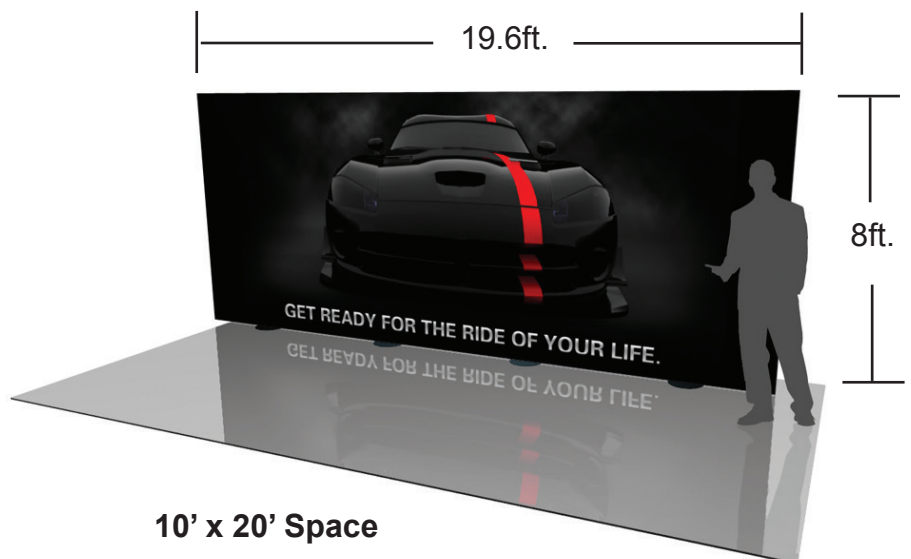

panoramic™ full visual system

PANORAMIC™ isn't just a graphic system...it is the graphic. It is the design. Design that surpasses all visual frame restrictions. Designs that utilize the entire display as a complete canvas. Graphics that completely cover the entire structure with your message. Think about the possibilities. One large graphic...a beautiful blank canvas just waiting for your creativity to explode without limits. The revolutionary full graphic system that puts the power of exhibit design, start to finish, in your hands.



**Think beyond the structure -
if you could, what would you create?**

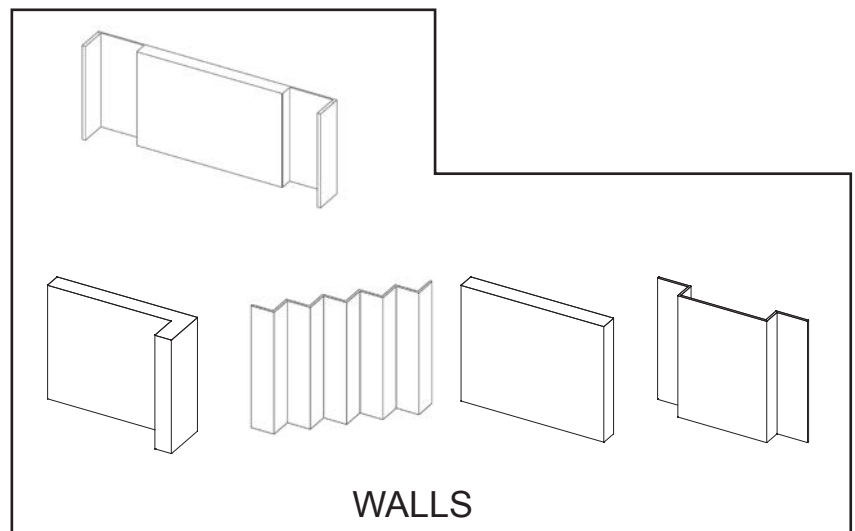
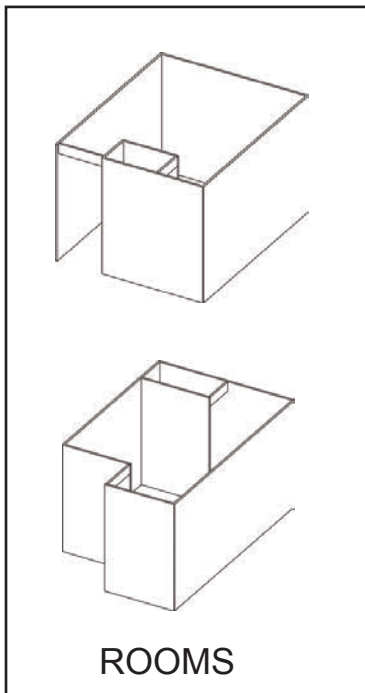
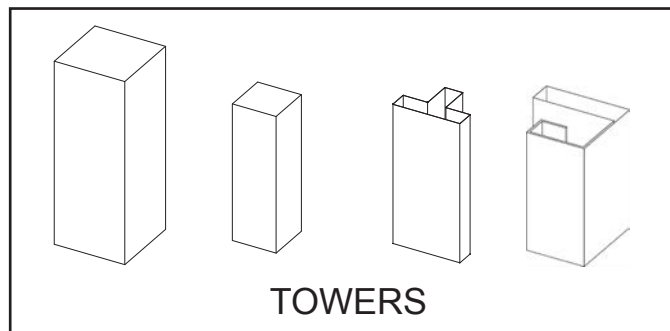

Add a Panoramic Exhibit Component to ANY existing extrusion system - Since the frame is covered by graphic - Panoramic goes with every display out there!

Panoramic is not available without purchase of SEG Fabric Graphics from Optima.

Preliminary Information. All structures and pricing are subject to change.

panoramic™ full visual system

Our Exhibit Component collection was developed by seasoned **exhibit space designers**. The collection reflects **universal solutions** that would work well **alone or with existing exhibit spaces**. Add a single Tower or put one in every corner of your exhibit. Since **Panoramic only shows graphics**, your artwork will carry the look and feel of any exhibit! Add some simple accessories and your **towers become useful workstations compatible with any environment**.

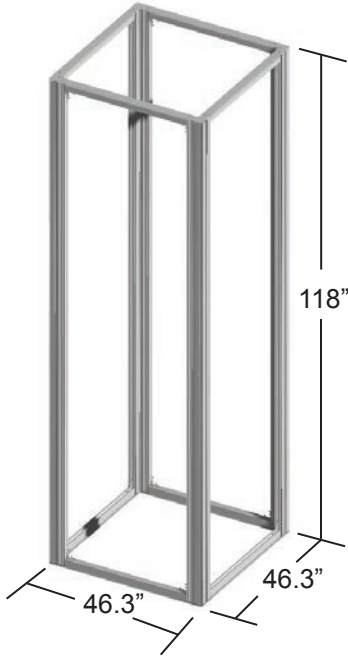

Tower A



Total Wholesale Pricing
(As Shown) \$2,814.00

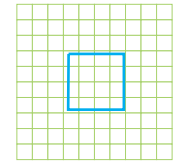

10' x 10'

Pricing & Specifications

Preliminary Information.

All structures and pricing are subject to change.

Item	Size	Qty.	Cost each	Total
Graphic	186.186" x 118.33"	1	\$1,453.46	\$1,453.46
L Profile	94"	4	\$172.73	\$690.90
L Profile	24"	4	\$44.10	\$176.40
Horizontal Profile	40"	8	\$21.00	\$168.00
Plastic Cover	N/A	8	\$4.05	\$32.40
Inside Corner	N/A	28	\$14.40	\$230.40
Lateral Connector	N/A	4	\$13.86	\$55.44
Leveling Feet & Nut	N/A	4	\$1.75	\$7.00

Total Wholesale Pricing \$2,814.00

Shipping Weight: 103.87 lbs

Recommended Packing - Cost: \$309.69 (add to Total Wholesale Pricing)

panoramic™ full visual system

Our Exhibit Component collection was developed by seasoned **exhibit space designers**. The collection reflects **universal solutions** that would work well **alone or with existing exhibit spaces**. Add a single Tower or put one in every corner of your exhibit. Since **Panoramic only shows graphics**, your artwork will carry the look and feel of any exhibit! Add some simple accessories and your **towers become useful workstations compatible with any environment**.

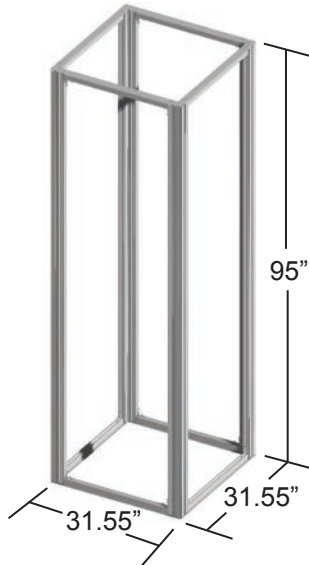

Tower B



Total Wholesale Pricing
(As Shown) \$1,866.64

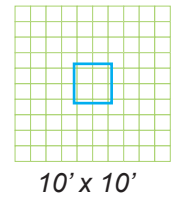

Pricing & Specifications

Preliminary Information.

All structures and pricing are subject to change.

Item	Size	Qty.	Cost each	Total
Graphic	127.186" x 95.33"	1	\$799.89	\$799.89
L Profile	94"	4	\$173.00	\$690.90
Horizontal Profile	24"	8	\$20.01	\$106.05
Plastic Cover	N/A	8	\$4.05	\$32.40
Inside Corner	N/A	16	\$14.40	\$230.40
Leveling Feet & Nut	N/A	4	\$1.75	\$7.00

Total Wholesale Pricing \$1,866.64

Shipping Weight: 97.58 lbs

Recommended Packing - Cost: \$309.69 (add to Total Wholesale Pricing)

panoramic™ full visual system

Our Exhibit Component collection was developed by seasoned **exhibit space designers**. The collection reflects **universal solutions** that would work well **alone or with existing exhibit spaces**. Add a single Tower or put one in every corner of your exhibit. Since **Panoramic only shows graphics**, your artwork will carry the look and feel of any exhibit! Add some simple accessories and your **towers become useful workstations compatible with any environment**.

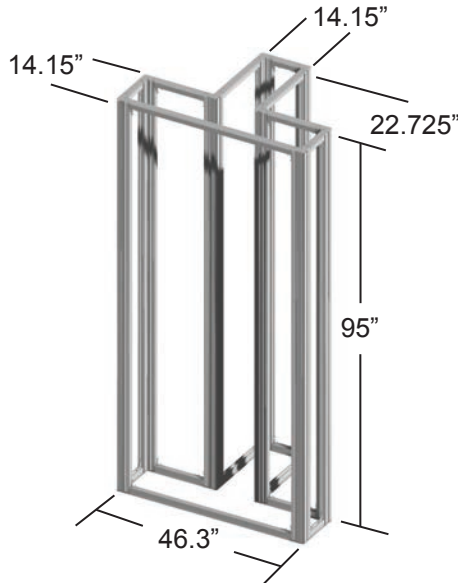

Tower C



Total Wholesale Pricing
(As Shown) \$2,825.35

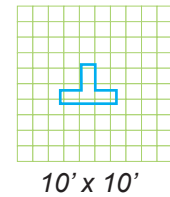

Pricing & Specifications

Preliminary Information.

All structures and pricing are subject to change.

Item	Size	Qty.	Cost each	Total
Graphic 1	60.56" x 95.35"	1	\$677.51	\$677.51
Graphic 2	107.706" x 95.35"	1	\$380.95	\$380.95
L Profile	94"	2	\$172.73	\$345.45
I Profile	94"	6	\$123.38	\$740.25
Horizontal Profile	40"	2	\$21.00	\$42.00
Horizontal Profile	11"	6	\$5.78	\$34.65
Horizontal Profile	18"	4	\$9.45	\$37.80
Horizontal Profile	11.35"	4	\$6.79	\$27.14
Plastic Cover L	N/A	4	\$4.05	\$16.20
Plastic Cover I	N/A	12	\$4.05	\$48.60
Inside Corner	N/A	32	\$14.40	\$460.80
Leveling Feet & Nut	N/A	8	\$1.75	\$14.00

Total Wholesale Pricing \$2,825.35

Shipping Weight: 133 lbs

Recommended Packing - Cost: \$309.69 (add to Total Wholesale Pricing)

panoramic™ full visual system

Our Exhibit Component collection was developed by seasoned **exhibit space designers**. The collection reflects **universal solutions** that would work well **alone or with existing exhibit spaces**. Add a single Tower or put one in every corner of your exhibit. Since **Panoramic only shows graphics**, your artwork will carry the look and feel of any exhibit! Add some simple accessories and your **towers become useful workstations compatible with any environment**.

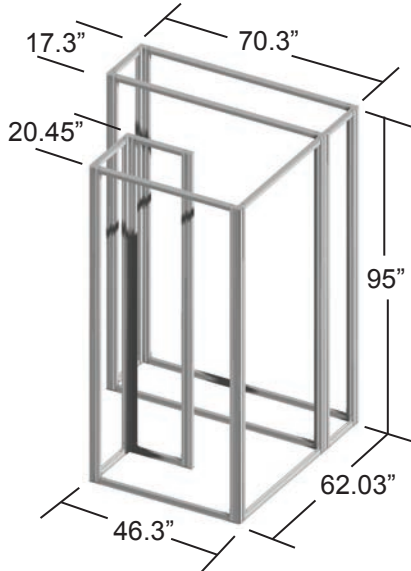

Tower D



Total Wholesale Pricing
(As Shown) \$4,918.38

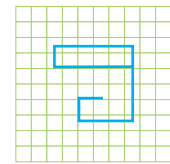

10' x 10'

Pricing & Specifications

Preliminary Information.

All structures and pricing are subject to change.

Item	Size	Qty.	Cost each	Total
Graphic 1	326.98" x 95.35"	2	\$277.63	\$555.26
Graphic 2 & 3	44.136" x 95.35"	1	\$114.99	\$114.99
Graphic 4	18.28" x 95.35"	1	\$2,056.16	\$2,056.85
L Profile	94"	6	\$172.73	\$1,036.35
I Profile	94"	1	\$123.38	\$123.38
T Profile	94"	1	\$222.08	\$222.08
Horizontal Profile	64"	4	\$33.60	\$134.40
Horizontal Profile	40"	4	\$21.00	\$84.00
Horizontal Profile	14.15"	4	\$7.43	\$29.72
Horizontal Profile	11"	4	\$5.78	\$23.10
Plastic Cover L	N/A	12	\$4.05	\$48.60
Plastic Cover I	N/A	2	\$4.05	\$8.10
Plastic Cover T	N/A	2	\$3.38	\$6.75
Inside Corner	N/A	32	\$14.40	\$460.80
Leveling Feet & Nut	N/A	8	\$1.75	\$14.00

Shipping Weight:
199.63 lbs

Recommended Packing - Cost:
\$309.69
(add to Total Wholesale Pricing)

Total Wholesale Pricing \$4,918.38

panoramic™ full visual system

Preliminary Information.

All structures and pricing are subject to change.

Our Exhibit Component collection was developed by seasoned **exhibit space designers**. The collection reflects **universal solutions** that would work well **alone or with existing exhibit spaces**. Save time in the design phase and select an existing Exhibit Component backwall to **create a complete inline display**. Need a **space definer** at your next exhibit? Add one of these **wall solutions**. Since **Panoramic only shows graphics**, your artwork will carry the look and feel of any exhibit! **With Panoramic, the entire display is covered with graphic** so your image will be on both sides of the wall.



Wall 10A

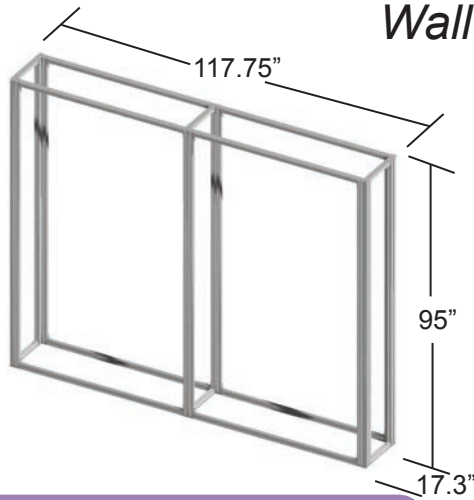

Total Wholesale Pricing
(As Shown) \$2,627.34

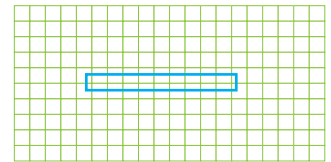

20' x 10'

Pricing & Specifications

Item	Size	Qty.	Cost each	Total
Graphic 1	153.04" x 95.35"	1	\$962.69	\$962.69
L Profile	94"	4	\$172.73	\$690.90
I Profile	94"	2	\$123.38	\$246.75
Horizontal Profile	54"	8	\$28.35	\$226.80
Horizontal Profile	11"	4	\$5.78	\$23.10
Horizontal Profile	14.15	2	\$7.43	\$14.86
Plastic Cover L	N/A	8	\$4.05	\$32.40
Plastic Cover I	N/A	4	\$4.05	\$16.20
Inside Corner	N/A	28	\$14.40	\$403.20
Leveling Feet & Nut	N/A	6	\$1.75	\$10.50

Total Wholesale Pricing \$2,627.34

Shipping Weight: 126.38 lbs

Recommended Packing - Cost: \$309.69 (add to Total Wholesale Pricing)

6/1/2011

SEG/Extrusion Systems

panoramic™ full visual system

Preliminary Information.

All structures and pricing are subject to change.

Our Exhibit Component collection was developed by seasoned **exhibit space designers**. The collection reflects **universal solutions** that would work well **alone or with existing exhibit spaces**. Save time in the design phase and select an existing Exhibit Component backwall to **create a complete inline display**. Need a **space definer** at your next exhibit? Add one of these **wall solutions**. Since **Panoramic only shows graphics**, your artwork will carry the look and feel of any exhibit! **With Panoramic, the entire display is covered with graphic** so your image will be on both sides of the wall.

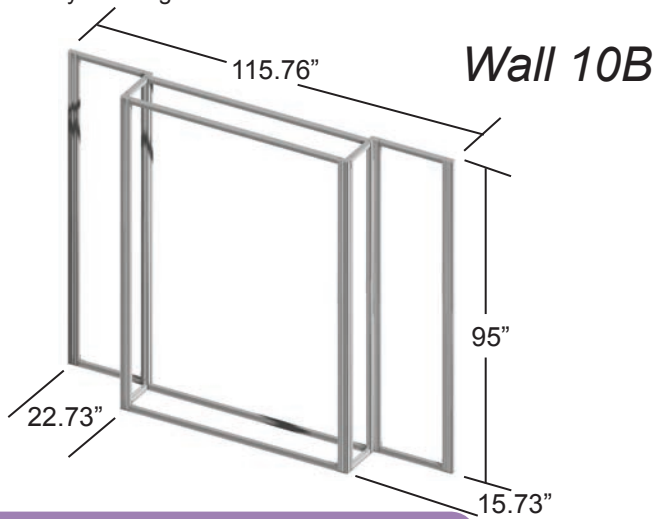

Total Wholesale Pricing
(As Shown) \$2,655.33

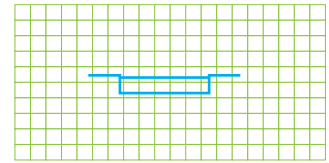

20' x 10'

Pricing & Specifications

Item	Size	Qty.	Cost each	Total
Graphic 1 & 3	25.27" x 95.35"	2	\$158.96	\$317.92
Graphic 2	102.72" x 95.35"	1	\$646.16	\$646.16
L Profile	94"	2	\$172.73	\$345.45
I Profile	94"	2	\$123.38	\$246.75
T Profile	94"	2	\$222.08	\$444.15
Horizontal Profile	64"	4	\$33.60	\$134.40
Horizontal Profile	18"	4	\$9.45	\$37.80
Horizontal Profile	11"	4	\$5.78	\$23.10
Plastic Cover L	N/A	4	\$4.05	\$16.20
Plastic Cover I	N/A	4	\$4.05	\$16.20
Plastic Cover T	N/A	4	\$3.38	\$13.50
Inside Corner	N/A	28	\$14.40	\$403.20
Leveling Feet & Nut	N/A	6	\$1.75	\$10.50

Total Wholesale Pricing \$2,655.33

Shipping Weight: 143.24 lbs

Recommended Packing - Cost: \$309.69 (add to Total Wholesale Pricing)

panoramic™ full visual system

Our Exhibit Component collection was developed by seasoned **exhibit space designers**. The collection reflects **universal solutions** that would work well **alone or with existing exhibit spaces**. Save time in the design phase and select an existing Exhibit Component backwall to **create a complete inline display**. Need a **space definer** at your next exhibit? Add one of these **wall solutions**. Since **Panoramic only shows graphics**, your artwork will carry the look and feel of any exhibit! **With Panoramic, the entire display is covered with graphic** so your image will be on both sides of the wall.

Preliminary Information.

All structures and pricing are subject to change.

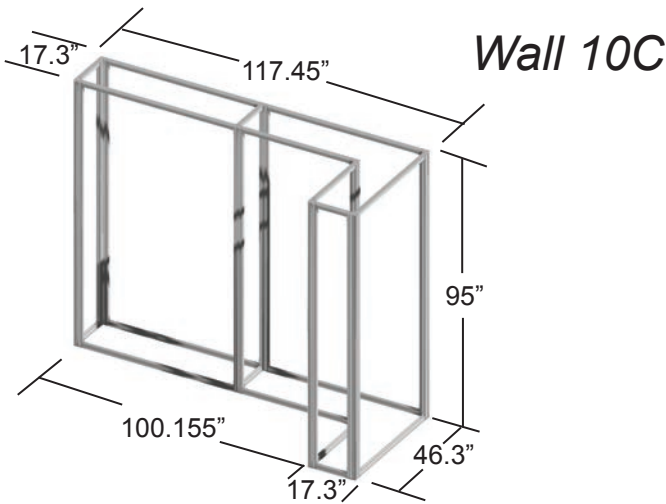

Total Wholesale Pricing
(As Shown) \$3,500.62

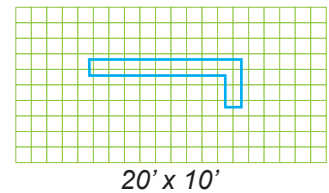

Pricing & Specifications

Item	Size	Qty.	Cost each	Total
Graphic 1	118.436" x 95.35"	1	\$745.01	\$745.01
Graphic 2	93.586" x 95.35"	1	\$588.37	\$588.37
L Profile	94"	6	\$172.73	\$1,036.35
I Profile	94"	2	\$123.38	\$246.75
Horizontal Profile	11"	4	\$5.77	\$23.10
Horizontal Profile	54"	6	\$28.35	\$170.10
Horizontal Profile	38.28"	2	\$20.10	\$40.19
Horizontal Profile	24.28"	2	\$12.75	\$25.49
Horizontal Profile	40"	2	\$21.00	\$42.00
Horizontal Profile	14.15"	2	\$7.43	\$14.86
Plastic Cover L	N/A	12	\$4.05	\$48.60
Plastic Cover I	N/A	4	\$4.05	\$16.20
Inside Corner	N/A	34	\$14.40	\$489.60
Leveling Feet & Nut	N/A	8	\$1.75	\$14.00

Total Wholesale Pricing \$3,500.62

Shipping Weight: 183.40 lbs

Recommended Packing - Cost: \$619.38 (add to Total Wholesale Pricing)

6/1/2011

SEG/Extrusion Systems

panoramic™ full visual system

Preliminary Information.

All structures and pricing are subject to change.

Our Exhibit Component collection was developed by seasoned **exhibit space designers**. The collection reflects **universal solutions** that would work well **alone or with existing exhibit spaces**. Save time in the design phase and select an existing Exhibit Component backwall to **create a complete inline display**. Need a **space definer** at your next exhibit? Add one of these **wall solutions**. Since **Panoramic only shows graphics**, your artwork will carry the look and feel of any exhibit! **With Panoramic, the entire display is covered with graphic** so your image will be on both sides of the wall.

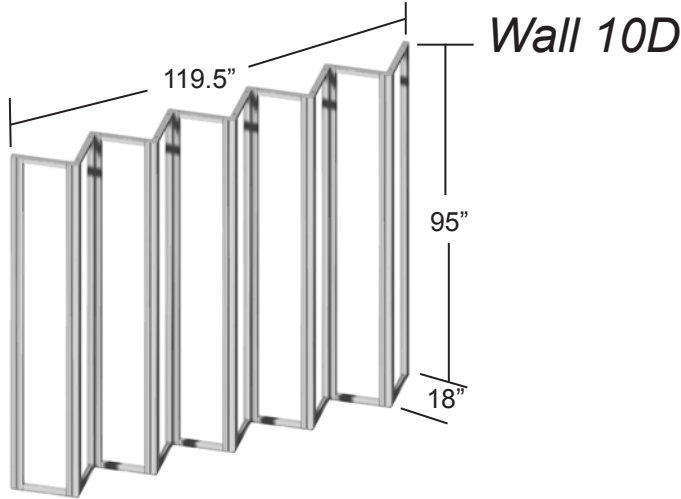

Total Wholesale Pricing
(As Shown) \$3,858.21

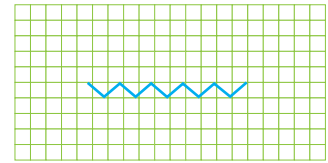

20' x 10'

Pricing & Specifications

Item	Size	Qty.	Cost each	Total
Graphic 1	51.29" x 95.35"	2	\$322.63	\$645.26
Graphic 2, 3 & 4	32.42" x 95.35"	3	\$203.94	\$611.82
L Profile	94"	9	\$172.73	\$1,554.53
I Profile	94"	2	\$123.38	\$246.75
Horizontal Profile	11"	20	\$10.05	\$115.50
Plastic Cover L	N/A	18	\$4.05	\$72.90
Plastic Cover I	N/A	4	\$4.05	\$16.20
Inside Corner	N/A	40	\$14.40	\$576.00
Leveling Feet & Nut	N/A	11	\$1.75	\$19.25

Total **Wholesale Pricing** \$3,858.21

Shipping Weight: 226.33 lbs

Recommended Packing - Cost: \$309.69 (add to Total Wholesale Pricing)

panoramic™ full visual system

Preliminary Information.

All structures and pricing are subject to change.

Our Exhibit Component collection was developed by seasoned **exhibit space designers**. The collection reflects **universal solutions** that would work well **alone or with existing exhibit spaces**. Save time in the design phase and select an existing Exhibit Component backwall to **create a complete inline display**. Need a **space definer** at your next exhibit? Add one of these **wall solutions**. Since **Panoramic only shows graphics**, your artwork will carry the look and feel of any exhibit! **With Panoramic, the entire display is covered with graphic** so your image will be on both sides of the wall.

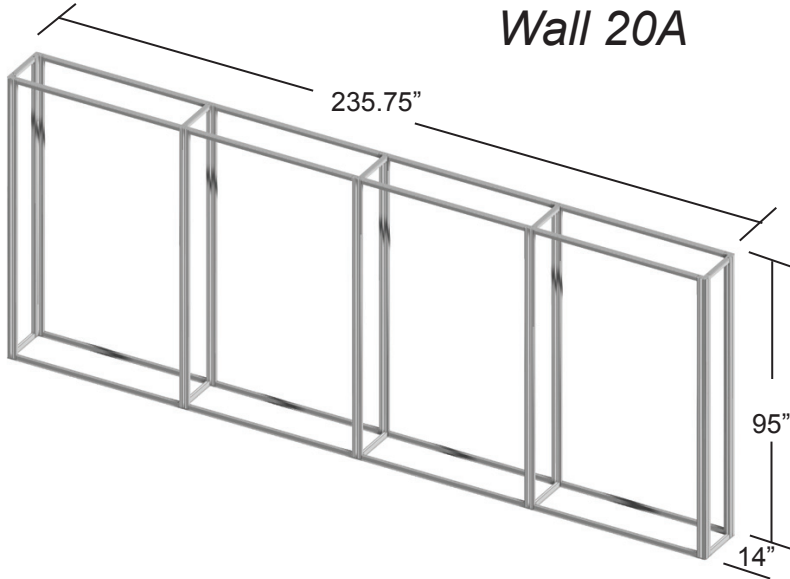

Total Wholesale Pricing
(As Shown) \$4,937.95

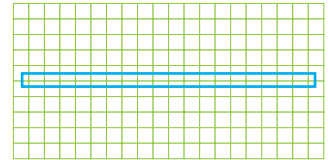

Pricing & Specifications

Item	Size	Qty.	Cost each	Total
Graphic 1	271.336" x 95.35"	1	\$1,706.83	\$1,706.83
L Profile	94"	4	\$172.73	\$690.90
I Profile	94"	6	\$193.88	\$1,163.25
Horizontal Profile	55"	16	\$28.88	\$462.00
Horizontal Profile	11"	4	\$5.78	\$23.10
Horizontal Profile	14.15"	6	\$7.43	\$44.57
Plastic Cover L	N/A	8	\$4.05	\$32.40
Plastic Cover I	N/A	12	\$4.05	\$48.60
Inside Corner	N/A	52	\$14.40	\$748.80
Leveling Feet & Nut	N/A	10	\$1.75	\$17.50

Total Wholesale Pricing \$4,937.95

Shipping Weight: 193.92 lbs

Recommended Packing - Cost: \$619.38 (add to Total Wholesale Pricing)

panoramic™ full visual system

Preliminary Information.

All structures and pricing are subject to change.

Our Exhibit Component collection was developed by seasoned **exhibit space designers**. The collection reflects **universal solutions** that would work well **alone or with existing exhibit spaces**. Save time in the design phase and select an existing Exhibit Component backwall to **create a complete inline display**. Need a **space definer** at your next exhibit? Add one of these **wall solutions**. Since **Panoramic only shows graphics**, your artwork will carry the look and feel of any exhibit! **With Panoramic, the entire display is covered with graphic** so your image will be on both sides of the wall.

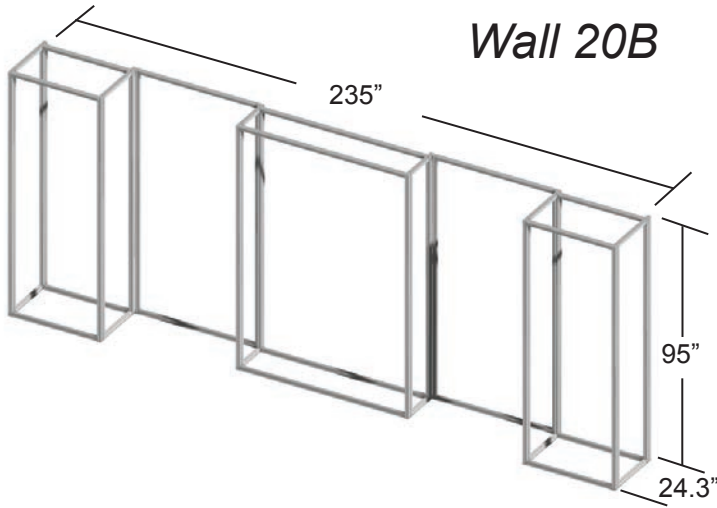

Total Wholesale Pricing
(As Shown) \$5,955.50

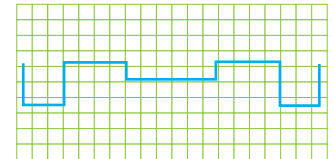

20' x 10'

Pricing & Specifications

Item	Size	Qty.	Cost each	Total
Graphic 1 & 5	84.14" x 95.33"	2	\$529.28	\$1,058.56
Graphic 2 & 4	49.13" x 95.35"	2	\$309.04	\$618.08
Graphic 3	102.72" x 95.35"	1	\$646.16	\$646.16
L Profile	94"	4	\$172.73	\$690.90
I Profile	94"	8	\$193.88	\$1,551.00
Horizontal Profile	64"	4	\$33.60	\$134.40
Horizontal Profile	33"	8	\$17.33	\$138.60
Horizontal Profile	45"	4	\$23.63	\$94.50
Horizontal Profile	18"	8	\$9.45	\$75.60
Horizontal Profile	11"	4	\$5.78	\$23.10
Plastic Cover L	N/A	8	\$4.05	\$32.40
Plastic Corner I	N/A	16	\$4.05	\$64.80
Inside Corner	N/A	56	\$14.40	\$806.40
Leveling Feet & Nut	N/A	12	\$1.75	\$21.00

Total Wholesale Pricing \$5,955.50

Shipping Weight: 234.96 lbs

Recommended Packing - Cost: \$619.38 (add to Total Wholesale Pricing)

panoramic™ full visual system

Preliminary Information.

All structures and pricing are subject to change.

Our Exhibit Component collection was developed by seasoned **exhibit space designers**. The collection reflects **universal solutions** that would work well **alone or with existing exhibit spaces**. Save time in the design phase and select an existing Exhibit Component backwall to **create a complete inline display**. Need a **space definer** at your next exhibit? Add one of these **wall solutions**. Since **Panoramic only shows graphics**, your artwork will carry the look and feel of any exhibit! **With Panoramic, the entire display is covered with graphic** so your image will be on both sides of the wall.

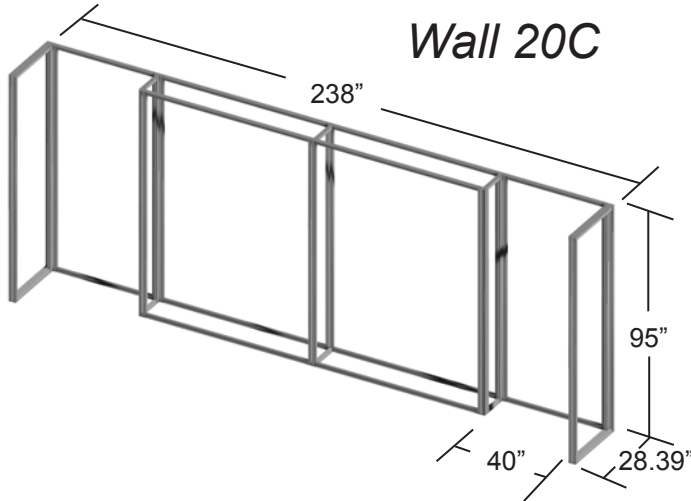

Total Wholesale Pricing
(As Shown) \$5,413.65

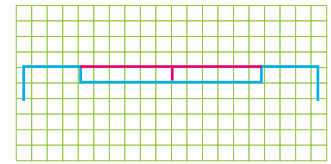

Pricing & Specifications

Item	Size	Qty.	Cost each	Total
Graphic 1 & 5	60.922" x 95.35"	2	\$383.23	\$766.46
Graphic 2 & 4	44.126" x 95.35"	2	\$277.57	\$555.14
Graphic 3	171.676" x 95.35"	1	\$1,079.92	\$1,079.92
L Profile	94"	2	\$172.73	\$345.45
I Profile	94"	4	\$123.38	\$493.50
T Profile	94"	4	\$222.00	\$888.30
Horizontal Profile	11.04"	2	\$5.79	\$11.59
Horizontal Profile	7.9"	4	\$4.14	\$16.59
Horizontal Profile	68"	8	\$35.70	\$285.60
Horizontal profile	40"	4	\$21.00	\$84.00
Horizontal Profile	23.68"	4	\$12.43	\$49.73
Horizontal Profile	25.25"	4	\$13.25	\$53.03
Plastic Cover L	N/A	4	\$4.05	\$16.20
Plastic Cover I	N/A	8	\$4.05	\$32.40
Plastic Cover T	N/A	8	\$3.38	\$27.04
Inside Corner	N/A	48	\$14.40	\$691.20
Leveling Feet & Nut	N/A	10	\$1.75	\$17.50

Total Wholesale Pricing \$5,413.65

Shipping Weight: 365.22 lbs

Recommended Packing - Cost: \$656.88 (add to Total Wholesale Pricing)

panoramic™ full visual system

Preliminary Information.

All structures and pricing are subject to change.

Our Exhibit Component collection was developed by seasoned **exhibit space designers**. The collection reflects **universal solutions** that would work well **alone or with existing exhibit spaces**. Save time in the design phase and select an existing Exhibit Component backwall to **create a complete inline display**. Need a **space definer** at your next exhibit? Add one of these **wall solutions**. Since **Panoramic only shows graphics**, your artwork will carry the look and feel of any exhibit! **With Panoramic, the entire display is covered with graphic** so your image will be on both sides of the wall.



Wall 20D

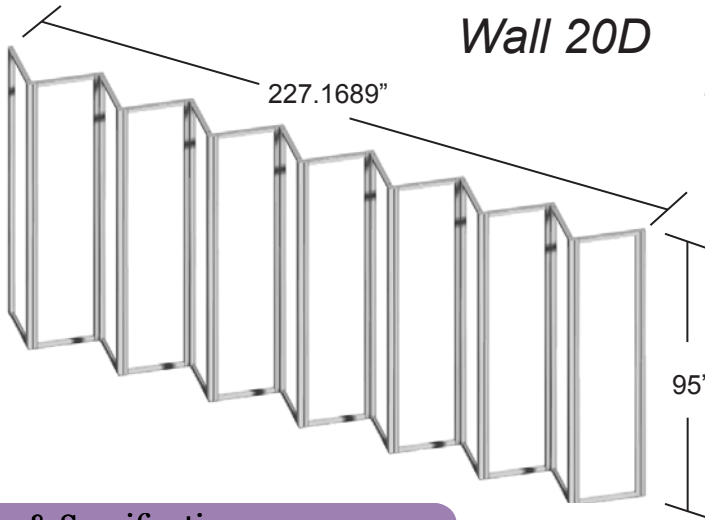

Total Wholesale Pricing
(As Shown) \$6,080.03

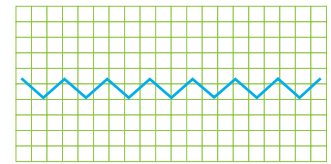

Pricing & Specifications

Item	Size	Qty.	Cost each	Total
Graphic 1	51.14" x 95.35"	2	\$454.55	909.10
Graphic 2	46.42" x 95.35"	5	\$292.00	\$1,460.00
L Profile	94"	13	\$172.73	\$2,245.43
I Profile	94"	2	\$123.38	\$246.75
Horizontal Profile	18"	28	\$9.45	\$264.60
Plastic Cover L	N/A	26	\$4.05	\$105.30
Plastic Cover I	N/A	4	\$4.05	\$16.20
Inside Corner	N/A	56	\$14.40	\$806.40
Leveling Foot & Nut	N/A	15	\$1.75	\$26.25

Total Wholesale Pricing \$6,080.03

Shipping Weight: 323.01 lbs

Recommended Packing - Cost: \$619.38 (add to Total Wholesale Pricing)

panoramic™ full visual system

Need a Room to meet with clients? **Panoramic Rooms** from our Exhibit Component collection are a **perfect solution**. Save time, save Money. Incorporate a Room that goes with anything! The collection reflects **universal solutions** that would **work well alone or with existing exhibit spaces**. Take advantage of these **pre-designed options** allowing you to focus on designing the layout of your message, inside and out! **Add Counters, Towers or Walls and you can create an entire exhibit space** entirely out of our Exhibit Components collection.

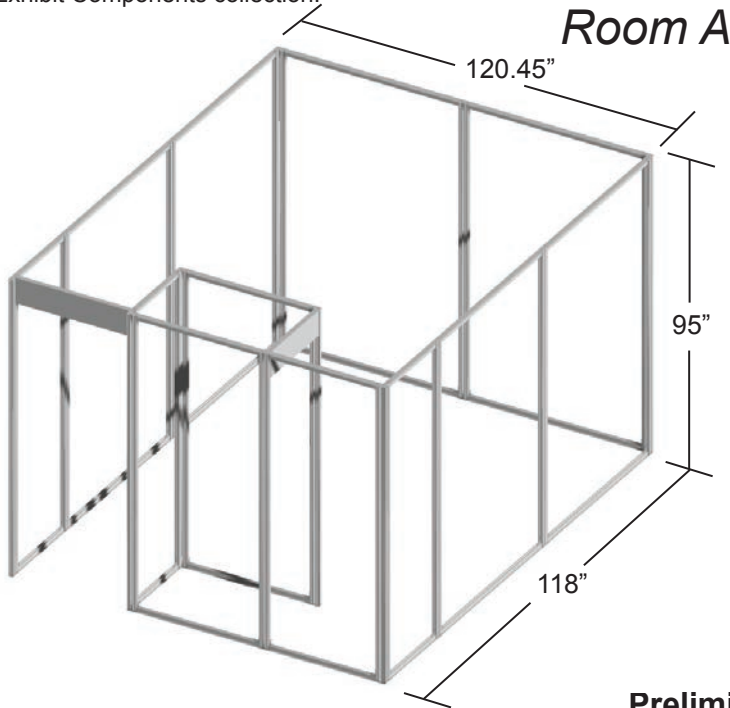

Total Wholesale Pricing
(As Shown) \$10,755.08

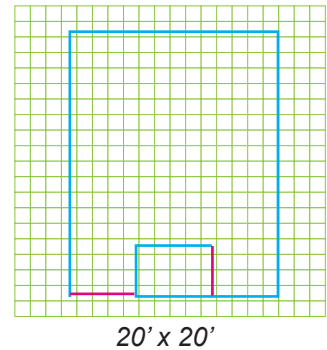

Pricing & Specifications

Preliminary Information.

All structures and pricing are subject to change.

Item	Size	Qty.	Cost each	Total
Graphic 1	117.87" x 95.33"	1	\$741.29	\$741.29
Graphic 2	146.27" x 95.33"	1	\$919.91	\$919.91
Graphic 3	80.27" x 95.33"	1	\$504.82	\$504.82
Graphic 4	27.12" x 95.33"	1	\$170.56	\$170.56
Graphic 5	91.57" x 95.33"	1	\$575.89	\$575.89
Graphic 6	112.73" x 95.33"	1	\$708.97	\$708.97
Graphic 7	149.43" x 95.33"	1	\$939.78	\$939.78
Graphic 8	121.03" x 95.33"	1	\$761.17	\$761.17
Graphic 9	296.29" x 95.33"	1	\$1,863.40	\$1,863.40
L Profile	94"	5	\$172.73	\$863.63
I Profile	94"	8	\$123.38	\$987.00
Horizontal Profile	55.5"	12	\$29.14	\$349.65
Horizontal Profile	25.25"	8	\$13.26	\$106.05
Horizontal Profile	39"	4	\$20.48	\$81.90
Horizontal Profile	32.85"	4	\$17.25	\$68.99
Horizontal Profile	8.15"	4	\$4.28	\$17.12

Item	Size	Qty.	Cost each	Total
Header 1	39.98" x 9.13"	1	\$24.08	\$24.08
Header 2	27.38" x 9.13"	1	\$16.49	\$16.49
Plastic Cover L	N/A	10	\$4.05	\$40.50
Plastic Cover I	N/A	16	\$4.05	\$64.80
Inside Corner	N/A	52	\$14.40	\$748.80
Outside Corner	N/A	8	\$10.80	\$86.40
Leveling Foot & Nut	N/A	13	\$1.75	\$22.75
Flat Bar	1" x .125" x 12"	9	\$10.13	\$91.13

Total Wholesale Pricing \$10,755.08

Shipping Weight: 276.13 lbs

Recommended Packing - Cost: \$656.88 (add to Total Wholesale Pricing)

panoramic™ full visual system

Need a Room to meet with clients? **Panoramic Rooms** from our Exhibit Component collection are a **perfect solution**. Save time, save Money. Incorporate a Room that goes with anything! The collection reflects **universal solutions** that would **work well alone or with existing exhibit spaces**. Take advantage of these **pre-designed options** allowing you to focus on designing the layout of your message, inside and out! **Add Counters, Towers or Walls and you can create an entire exhibit space** entirely out of our Exhibit Components collection.

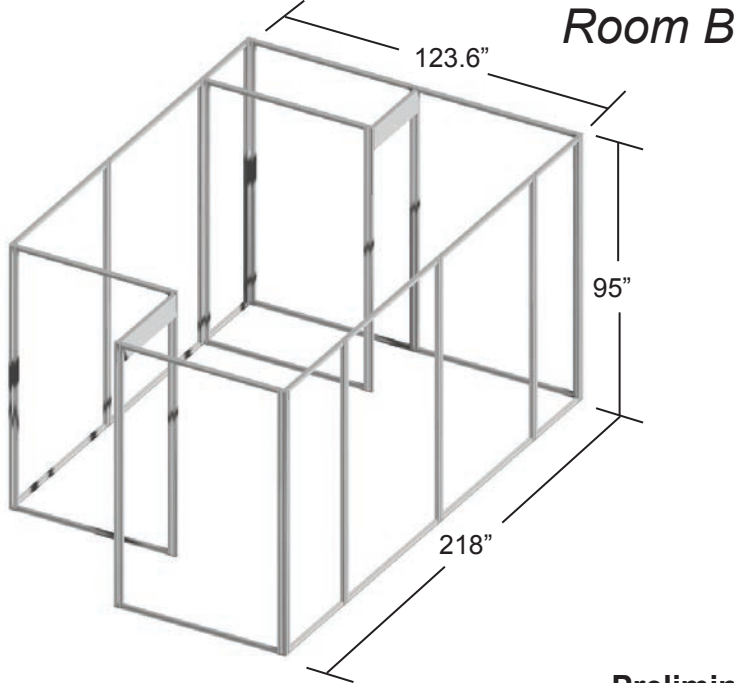

Total Wholesale Pricing
(As Shown) \$11,614.22

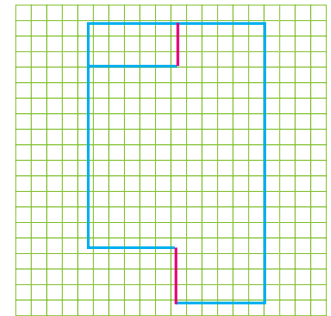

Preliminary Information.

20' x 20'

All structures and pricing are subject to change.

Pricing & Specifications

Item	Size	Qty.	Cost each	Total
Graphic 1 & 6	117.87" x 95.33"	2	\$741.29	\$1,482.59
Graphic 2	182.42" x 95.33"	1	\$1,147.26	\$1,147.26
Graphic 3 & 7	122.59" x 95.33"	2	\$770.98	\$1,541.96
Graphic 4	305.63" x 95.33"	1	\$1,922.14	\$1,922.14
Graphic 5	264.70" x 95.33"	1	\$1,664.73	\$1,664.73
Graphic 8	27.80" x 95.33"	1	\$174.83	\$174.83
L Profile	94"	4	\$172.73	\$690.90
I Profile	94"	8	\$123.38	\$987.00
T Profile	94"	1	\$222.08	\$222.08
Horizontal Profile	55.5"	18	\$29.18	\$524.48
Horizontal Profile	25.25"	6	\$13.26	\$79.54
Horizontal Profile	33"	2	\$17.33	\$34.65
Horizontal Profile	29.85"	2	\$15.67	\$31.34
Horizontal Profile	8.15"	4	\$4.28	\$17.12

Item	Size	Qty.	Cost each	Total
Header 1	39.98" x 9.13"	1	\$24.08	\$24.08
Header 2	27.38" x 9.13"	1	\$16.49	\$16.49
Plastic Cover L	N/A	8	\$4.05	\$32.40
Plastic Cover I	N/A	16	\$4.05	\$64.80
Plastic Cover T	N/A	2	\$3.38	\$6.75
Inside Corner	N/A	52	\$14.40	\$748.80
Outside Corner	N/A	8	\$10.80	\$86.40
Leveling Foot & Nut	N/A	13	\$1.75	\$22.75
Flat Bar	1" x .125" x 12"	9	\$10.13	\$91.13

Total Wholesale Pricing \$11,614.22

Shipping Weight: 276.13 lbs

Recommended Packing - Cost: \$656.88 (add to Total Wholesale Pricing)

panoramic™ full visual system

A Counter is a Counter is a Counter only until you've seen the Panoramic counters. **With storage space and sturdy composition**, these Counters support more than is necessary while **providing all the storage typically needed**. These versatile Counters convey **a style that goes with anything**. As with all Panoramic, the extrusion-based structure is hidden so the Counters go with any existing exhibits you may be updating. Connect Counters to Towers and **create unique workstations or presentation areas within your space**.



Counter A

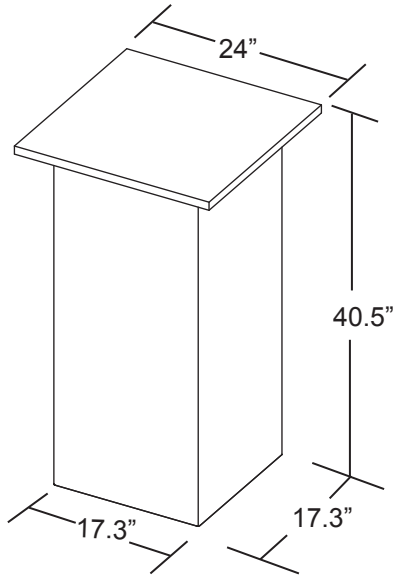

Total Wholesale Pricing
(As Shown) \$861.39

Pricing & Specifications

Preliminary Information.

All structures and pricing are subject to change.

Item	Size	Qty.	Cost each	Total
Graphic	70.186" x 40.33"	1	\$186.74	\$186.74
L Profile	39"	4	\$71.66	\$286.65
Horizontal Profile	11"	8	\$5.78	\$46.20
Plastic Cover L	N/A	8	\$4.05	\$32.40
Inside Corner	N/A	16	\$14.40	\$230.40
Counter Top	24" x 24"	1	\$72.00	\$72.00
Leveling Feet & Nut	N/A	4	\$1.75	\$7.00

Total Wholesale Pricing \$861.39

Shipping Weight: 67.53 lbs

Recommended Packing - Cost: \$237.48 (add to Total Wholesale Pricing)

panoramic™ full visual system

A Counter is a Counter is a Counter only until you've seen the Panoramic counters. **With storage space and sturdy composition**, these Counters support more than is necessary while **providing all the storage typically needed**. These versatile Counters convey **a style that goes with anything**. As with all Panoramic, the extrusion-based structure is hidden so the Counters go with any existing exhibits you may be updating. Connect Counters to Towers and **create unique workstations or presentation areas within your space**.



Counter B

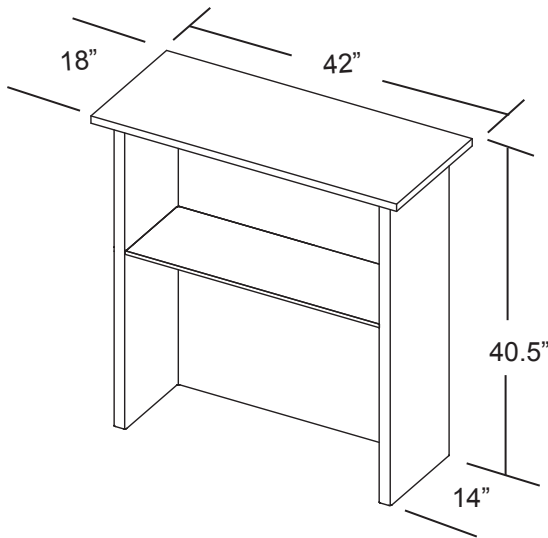

Total Wholesale Pricing
(As Shown) \$887.69

Pricing & Specifications

Preliminary Information.

All structures and pricing are subject to change.

Item	Size	Qty.	Cost each	Total
Graphic	75.486" x 40.32"	1	\$200.79	\$200.79
L Profile	39"	4	\$71.63	\$286.65
Horizontal Profile	8.15"	4	\$4.28	\$17.12
Horizontal Profile	33"	2	\$17.33	\$34.65
Plastic Cover L	N/A	8	\$4.05	\$32.40
Inside Corner	N/A	12	\$14.40	\$172.80
Counter Top	18" x 42"	1	\$63.00	\$63.00
Shelf Support	N/A	4	\$13.32	\$53.28
Internal Shelf	36" x 11"	1	\$20.00	\$20.00
Leveling Feet & Nut	N/A	4	\$1.75	\$7.00

Total Wholesale Pricing \$887.69

Shipping Weight: 68.48 lbs

Recommended Packing - Cost: \$237.48 (add to Total Wholesale Pricing)

panoramic™ full visual system

A Counter is a Counter is a Counter only until you've seen the Panoramic counters. **With storage space and sturdy composition**, these Counters support more than is necessary while **providing all the storage typically needed**. These versatile Counters convey **a style that goes with anything**. As with all Panoramic, the extrusion-based structure is hidden so the Counters go with any existing exhibits you may be updating. Connect Counters to Towers and **create unique workstations or presentation areas within your space**.



Counter C

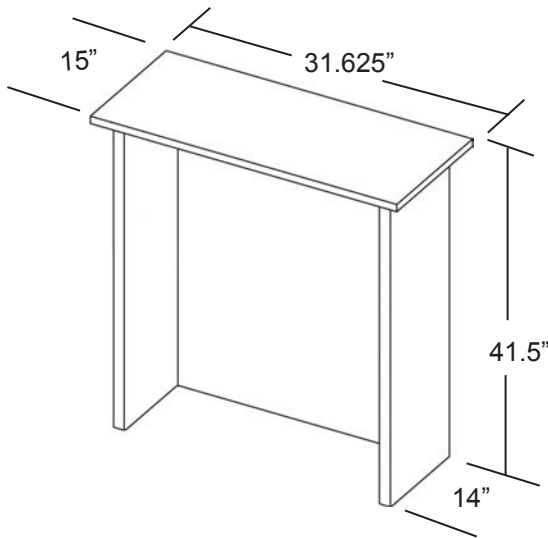

Total Wholesale Pricing
(As Shown) \$697.19

Pricing & Specifications

Preliminary Information.

All structures and pricing are subject to change.

Item	Size	Qty.	Cost each	Total
Graphic	61.416" x 41.32"	1	\$167.42	\$167.42
L Profile	40.75"	4	\$53.49	\$213.94
Horizontal Profile	8.15"	4	\$4.28	\$17.12
Horizontal Profile	25.25"	2	\$13.26	\$26.51
Plastic Cover L	N/A	8	\$4.05	\$32.40
Inside Corner	N/A	12	\$14.40	\$172.80
Counter Top	15" x 36"	1	\$60.00	\$60.00
Leveling Feet & Nut	N/A	4	\$1.75	\$7.00

Total Wholesale Pricing \$697.19

Shipping Weight: 43.48 lbs

Recommended Packing - Cost: \$237.48 (add to Total Wholesale Pricing)

panoramic™
full visual system

Frame Hardware

● Pricing

Aluminum Profiles:

Horizontal Profile



Call for a quote.

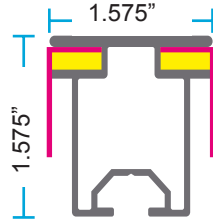

Key:

- Fabric graphic
- Extrusion frame
- SEG {silicone edge graphics}

LF - Per / Linear Foot

L Profile



Call for a quote.

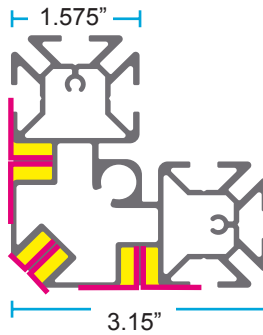

Cap for L Profile



\$4.05 ea

T Profile



Call for a quote.

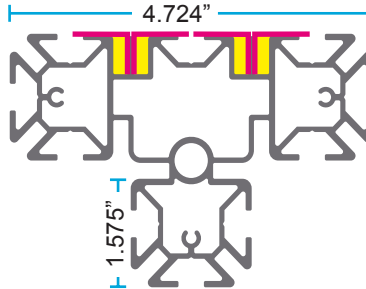

Cap for T Profile



\$3.38 ea

I Profile



Call for a quote.

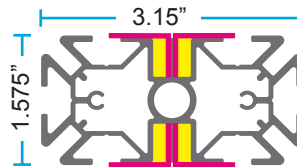

Cap for I Profile

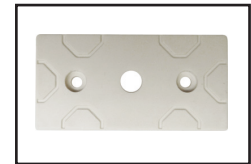

\$4.05 ea

IP Profile



Call for a quote.

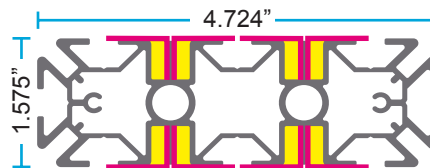

Cap for IP Profile



\$4.05 ea

● Pricing

Connectors:

Inside Corner Bracket



\$14.40 ea

Outside Corner Bracket



\$10.00 ea

Corner Shelf Support



Call for details.

Lateral Joint



\$15.00 ea

Junction Link



\$22.00 ea

Adds support to framework and can be used in place of support bars.

Supports:

Corner Brace

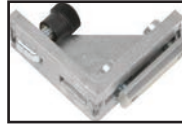

\$10.00 ea

Support Bar



Call for a quote.

Accessories

Outfit your custom designs with functional and attractive accessories. Mount monitors, stand-offs, shelving and bases are all engineered to work perfectly with your design. The PANORAMIC™ convenient casing system has been developed to accommodate and protect the exhibit during shipping and storage.

panoramic™ full visual system

SEG/Extrusion Systems

Pricing

Monitor Mounts:

Monitor Mount \$75 ea

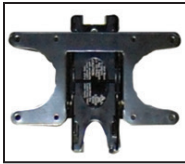

Mounts up to 26" monitor and 14lbs.

Mount style shown and cost is subject to change.

Large Flat Panel Mount \$12ea



Mounts 30" to 60" monitor and holds up to 130lbs.

Weight: 11.45lbs.
Shipping Box Size: 33" x 9" x 5"

Mount style shown and cost is subject to change.

Additional structure and support required when using monitor mounts. Contact your Account Representative for details.

Lighting:

LED Wall Washer



\$88ea

Style shown and cost is subject to change.

150/200 Watt Light



150w - \$42ea
200w - \$68ea

Style shown and cost is subject to change.

50 Watt Perf



\$59ea

Style shown and cost is subject to change.

Shelving:

Rectangular Shelf with brackets \$147ea



Size: 36" x 14" x 5"
Color: Black
Holds up to 50lbs. depending on frame structure.

Style shown and cost is subject to change.

Media Stations:

iPad Clamshell
Price \$75ea
Dimensions:
12"H x 8.25"W x 1"d



iPad Clamshell Swivel
Price \$115ea
Dimensions:
12"H x 8.25"W x 1.5"d



Style shown and cost is subject to change.

Lighting Adapters:



One light adapter.
\$14.50ea



Two light adapter.
\$17ea

Style shown and cost is subject to change.

panoramic™

full visual system

Accessories

Outfit your custom designs with functional and attractive accessories. Mount monitors, stand-offs, shelving and bases are all engineered to work perfectly with your design. The PANORAMIC™ convenient casing system has been developed to accommodate and protect the exhibit during shipping and storage.

Pricing

Bases:

Flower Base \$54.00 ea



Style shown and cost is subject to change.

Round Base \$54.00 ea



Style shown and cost is subject to change.

16" Peanut Base \$54.00 ea



Dimensions:
16.62"L x 3.5"W

Style shown and cost is subject to change.

Leveling Foot & Nut \$1.75 ea



23" Peanut Base \$54.00 ea



Dimensions:
23.62"L x 3.5"W

Style shown and cost is subject to change.

Literature Holder:



\$57.00 ea

Dimensions: 10"W x 14"H

- Holds up to 8.5" x 11" literature
- Steel construction
- Dark Grey color

Additional structure and support required when using this holder. Contact your Account Representative for details.

Panel Clamp:



\$16.00 ea

Dimensions: .75"W x 1"H

- Holds material up to a 1/4" thickness
- Aluminum construction
- Silver color

Substrate attached to Panoramic frame with Panel Clamps.



It is recommended to use at least 2 clamps on a 48"H wing panel, 4 on a 96"H panel.

Hinged Door Kit:

\$ 386.00 ea kit (add an additional \$201.00 per door graphic.)



Includes:

- Frame, support and corner brackets
- Locking door handle
- Cable w/ clamps
- Steel turnbuckle
- Hinges (2)
- Threshold with brackets

Custom door sizes available up to max 48" x 96". Additional structure, support and header frames will be required when using a door. Contact your Account Representative for details.

panoramic™ full visual system

Accessories

Outfit your custom designs with functional and attractive accessories. Mount monitors, stand-offs, shelving and bases are all engineered to work perfectly with your design. The PANORAMIC™ convenient casing system has been developed to accommodate and protect the exhibit during shipping and storage.

Pricing

Casing:

Large Panoramic Crate Price: \$657ea
 Dimension:
 26.5" x 30" x 98" (interior)
 31.5" x 37" x 103" (exterior)
 Weight: 208 lbs

- Hinged top lid
- Tool-free latch closure
- Wood construction
- Protective foam inserts
- Recommended use:
10' - 20' walls & rooms



Style shown and cost is subject to change.

Small Panoramic Crate Price: \$310ea
 Dimension:
 21" x 13" x 98" (interior)
 26" x 20" x 103" (exterior)
 Weight: 205 lbs

- Hinged top lid
- Tool-free latch closure
- Wood construction
- Protective foam inserts
- Recommended use:
towers & 10' walls



Style shown and cost is subject to change.

Small Panoramic Case Price: \$238ea
 Dimension:
 24" x 9" x 46.5"/48" (interior)
 28" x 10" 52" (exterior)
 Weight: 30 lbs

- Tool-free strap closure
- Molded plastic construction
- Protective foam inserts
- Recommended use:
Counters



Style shown and cost is subject to change.

Large Panoramic Case



Price: \$2,200ea
 Dimension:
 36" x 21" x 96" (interior)
 45" x 34" x 106" (exterior)
 Weight: 225 lbs

- Hinged top lid
- Tool-free latch closure
- Molded plastic construction
- Protective foam inserts
- Recommended use:
10' - 20' walls & rooms

Style shown and cost is subject to change.

Small Panoramic Pallet



Price: \$288 - \$312 ea
 Dimension:
 24" x 15" x 108" (min)
 24" x 24" x 108" (max)
 Weight: 85-91 lbs

- Cardboard wrap
- Metal strapping
- Wood / Cardboard construction
- Protective foam inserts
- Recommended use:
towers, walls & rooms

Style shown and cost is subject to change.

Small Panoramic Pallet - no foam inserts



Price: \$150 ea
 Dimension:
 24" x 15" x 108" (min)
 24" x 24" x 108" (max)
 Weight: 79 lbs

- Cardboard wrap
- Metal strapping
- Wood / Cardboard construction
- Cello foam wrap,
no foam inserts
- Recommended use:
hardware only, walls & rooms

Style shown and cost is subject to change.

Silicone Edged Graphic system (SEG)

SEG is a high-resolution dye-sublimated fabric graphic finished with a thin silicone strip. The silicone strip is sewn directly to the edge of the graphic, and the strip is then inserted into a frame with a recessed groove. The size of the graphic must be precise so the fabric is taut when installed in the frame. The result is a large format graphic that mimics the old fashioned hard panel graphics commonly found on custom displays and interior spaces.

Labor costs are drastically decreased with SEG graphics. SEG graphics install quickly and easily-often by only one individual. Change-out can occur in minutes and take down is even quicker. The graphics fold easily for storage. Messages can be displayed on the same structure without taking up non-existent space.

The result of the SEG graphics is striking. The fabric graphics mimic the old-time custom wall board or hard panel style graphics without all the hassle. Since SEG graphics are fabric, your booth will be glare-free and present a warm feeling with vivid color and deep presence.

Pricing

Kaleidoscope Select 4 color & Colossus 8 color SEG fabric graphics	\$9.00 per sqft
--	-----------------



SEG Silicone strip edge inserts into the groove of the frame giving a seamless look.

What is different or special about SEG?

- Superior Fabric. The fabric is from only high quality vendors.
- Versatile. SEG can be used on many extrusion profiles.
- Quality. The fabric undergoes a painstaking pre-inspection before the images are printed.
- Dye-Sublimation. Dye-sublimation graphics are durable, vibrant, and lightweight.
- Less Frame. SEG graphics are the perfect choice when more graphic and less frame is desired.
- No Sew Line. Unlike bead or pole pocket finished graphics, the sew line is hidden within the extrusion providing a more finished look to your exhibit or retail wall display.

What are the benefits of SEG?

- Storage and Shipping. Fabric is lighter than many other graphics. When folded neatly, fabric graphics take up much less space than traditional direct print graphics.
- Care. Fabric graphics can be washed and steamed and are just as durable and long lasting as traditional graphics.
- Lightweight. Larger graphics weigh less, perfect for draping or creating space definition.
- Cost. More image bang for the buck!
- Green. There are the obvious transportation and storage benefits. Even more exciting is the growing list of fabric options created from recycled materials.
- * No Glare. Fabric is the perfect choice for media walls or any backdrop that is being photographed or video recorded.
- * Versatility. SEG fabric can be applied to most displays or event structures.
- * Less Visible Frame. The silicone edge means you see more graphic and less frame.

panoramic™ full visual system

and select an existing Panoramic™ Kit to create a complete display. Since Panoramic™ only shows graphics, your artwork will carry the look and feel of any exhibit! With Panoramic™, the entire display is covered with graphic so your image will be on both sides of the wall.



*Total Cost Of Kit As Shown \$3,545

10' x 10' Kit A

Basic Kit Itemization

- 118" w x 24" d x 95" h Backwall w/graphic

Basic Kit Wholesale Total \$3,215

As Shown Itemization*

- 3 Lights with Adapters - \$222

Shipping Crate cost \$310

Total estimated Kit & Crate Shipping Weight: 336lbs



*Total Cost Of Kit As Shown \$4,438

10' x 10' Kit B

Basic Kit Itemization

- 118" w x 1.575" d x 95" h Backwall w/graphic - \$1,436
- 24" w x 84" d x 42" h Side Counter w/graphic - \$1,883
- 18" w x 18" d x 42" h Podium w/graphic - \$778

Basic Kit Wholesale Total \$4,097

As Shown Itemization*

- 1 Light with Adapter - \$74
- 1 Large Monitor Mount - \$267

Shipping Crate cost \$657

Total estimated Kit & Crate Shipping Weight: 384lbs

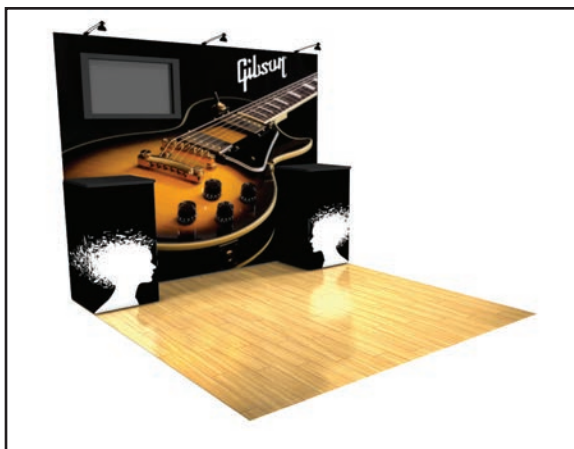

*Total Cost Of Kit As Shown \$3,663

10' x 10' Kit C

- 118" w x 1.575" d x 95" h Backwall w/graphic - \$1,436
- 24" w x 24" d x 42" h 2 Side Counters w/graphic - \$1,738

Basic Kit Wholesale Total \$3,174

As Shown Itemization*

- 3 Lights with Adapters - \$222
- 1 Large Monitor Mount - \$267

Shipping Crate cost \$310

Total estimated Kit & Crate Shipping Weight: 381lbs

Monitor & Floor graphics not included in the kit price.

panoramic™ full visual system

and select an existing Panoramic™ Kit to create a complete display. Since Panoramic™ only shows graphics, your artwork will carry the look and feel of any exhibit! With Panoramic™, the entire display is covered with graphic so your image will be on both sides of the wall.

Our Panoramic™ Kit collection was developed by seasoned exhibit space designers. The collection reflects universal solutions that would work well alone or with existing exhibit spaces. Save time in the design phase



Total Cost Of Kit As Shown \$4,681

10' x 10' Kit D

Basic Kit Itemization

- 118" w x 45.675" d x 95" h Backwall w/ graphic - \$3,903
- 18" w x 18" d x 42" h Podium w/graphic - \$778

Basic Kit Wholesale Total \$4,681

Shipping Crate cost \$657

Total estimated Kit & Crate Shipping Weight: 443lbs



*Total Cost Of Kit As Shown \$4,978

10' x 10' Kit E

- 118" w x 45.675" d x 95" h Backwall, Door & Storage w/graphic - \$3,096
 - 24" w x 24" d x 42" h Side Counter w/graphic - \$882
 - 18" w x 18" d x 42" h Podium w/graphic - \$778
- Basic Kit Wholesale Total \$4,756**

As Shown Itemization*

- 3 Lights with Adapters - \$222

Shipping Crate cost \$657

Total estimated Kit & Crate Shipping Weight: 422lbs

Monitor & Floor graphics
not included in the kit price.

panoramic™ full visual system

and select an existing Panoramic™ Kit to create a complete display. Since Panoramic™ only shows graphics, your artwork will carry the look and feel of any exhibit! With Panoramic™, the entire display is covered with graphic so your image will be on both sides of the wall.

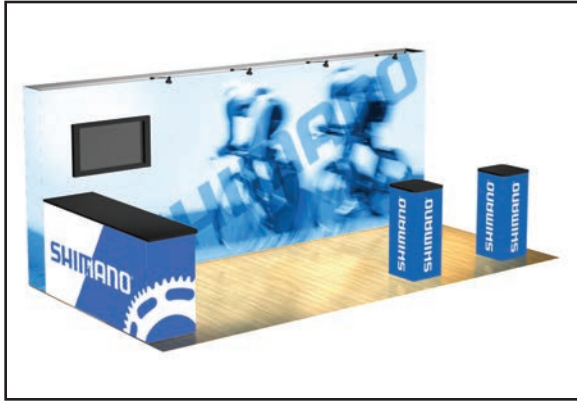

*Total Cost Of Kit As Shown \$8,196

10' x 20' Kit A

Basic kit Itemization

- 235.75" w x 17.3" d x 95" h Backwall w/graphic - \$4,149
- 24" w x 90" d x 42" h Side Counter w/graphic - \$1,929
- 18" w x 18" d x 42" h 2 Podiums with graphic - \$1,555

Basic Kit Wholesale Total \$7,633

As Shown Itemization*

- 4 Lights with Adapters - \$296
- 1 Large Monitor Mount - \$267

Shipping Crate cost \$657

Total estimated Kit & Crate Shipping Weight: 598lbs



Total Cost Of Kit As Shown \$9,593

10' x 20' Kit B

Basic Kit Itemization

- 236.025" w x 45.675" d x 95" h Backwall, Door & Storage w/graphic - \$5,939
- 18" w x 18" d x 42" h 2 Small Podiums w/graphic - \$1,691
- 48" w x 24" d x 42" h Counter w/graphic - \$1,326

Basic Kit Wholesale Total \$8,956

As Shown Itemization*

- 5 Lights with Adapters - \$370
- 1 Large Monitor Mount - \$267

Shipping Crate cost \$657

Total estimated Kit & Crate Shipping Weight: 580lbs



Total Cost Of Kit As Shown \$6,795

10' x 20' Kit C

Basic kit Itemization

- 237.45" w x 45.375" d x 95" h Backwall, Door & Storage w/graphic - \$4,410
- 18" w x 18" d x 42" h 2 Podiums w/graphic - \$1,555

Basic Kit Wholesale Total \$5,965

As Shown Itemization*

- 4 Lights with Adapters - \$296
- 2 Large Monitor Mounts - \$534

Shipping Crate cost \$657

Total estimated Kit & Crate Shipping Weight: 478lbs

Monitor & Floor graphics not included in the kit price.

panoramic™ full visual system

and select an existing Panoramic™ Kit to create a complete display. Since Panoramic™ only shows graphics, your artwork will carry the look and feel of any exhibit! With Panoramic™, the entire display is covered with graphic so your image will be on both sides of the wall.



*Total Cost Of Kit As Shown \$6,560

10' x 20' Kit D

Basic Kit Itemization

- 236" w x 45.375" d x 95" h Backwall, Door & Storage w/graphic - \$6,190

Basic Kit Wholesale Total \$6,190

As Shown Itemization*

- 5 Lights with Adapters - \$370

Shipping Crate cost \$657

Total estimated Kit & Crate Shipping Weight: 509lbs



*Total Cost Of Kit As Shown \$7,759

10' x 20' Kit E

Basic Kit Itemization

- 236" w x 47.375" d x 95" h Backwall, Door & Storage w/graphic - \$4,369
- 24" w x 24" d x 42" h 2 Podiums w/graphic - \$1,764
- 48" w x 24" d x 42" h Counter w/graphic - \$1,330

Basic Kit Wholesale Total \$7,463

As Shown Itemization*

- 4 Lights with Adapters - \$296

Shipping Crate cost \$657

Total estimated Kit & Crate Shipping Weight: 516lbs



*Total Cost Of Kit As Shown \$5,857

10' x 20' Kit F

Basic Kit Itemization

- 235" w x 50" d x 95" h Backwall, Door & Storage w/graphic - \$4,641
- 18" w x 18" d x 42" h 2 Podiums w/graphic - \$846

Basic Kit Wholesale Total \$5,487

As Shown Itemization*

- 5 Lights with Adapters - \$370

Shipping Crate cost \$657

Total estimated Kit & Crate Shipping Weight: 438lbs

Monitor & Floor graphics not included in the kit price.

panoramic™ full visual system

and select an existing Panoramic™ Kit to create a complete display. Since Panoramic™ only shows graphics, your artwork will carry the look and feel of any exhibit! With Panoramic™, the entire display is covered with graphic so your image will be on both sides of the wall.



*Total Cost Of Kit As Shown \$8,054

10' x 20' Kit G

Basic Kit Itemization

- 235" w x 50" d x 95" h Backwall, Door & Storage w/graphic - \$5,993
- 18" w x 18" d x 42" h 2 Podiums w/graphic - \$1,691

Basic Kit Wholesale Total \$7,684

As Shown Itemization*

- 5 Lights with Adapters - \$370

Shipping Crate cost \$657

Total estimated Kit & Crate Shipping Weight: 498lbs



Total Cost Of Kit As Shown \$8,102

10' x 20' Kit H

Basic Kit Itemization

- 235" w x 50" d x 95" h Backwall, with graphic that can separate into two 10' displays - \$6,810
- 54" h x 15.5" w x 15.5" d 2 iPad Kiosks with graphics - \$672
- 26" x 20" x 103" 2 Small Panoramic Crates for each 10' set - \$620

Basic Kit Wholesale Total \$8,102

(Total includes cost for 2 small Panoramic Crates for each 10' set.)

Total estimated each 10' Kit & Crate Shipping Weight: 360lbs each



Total Cost Of Kit As Shown \$6,373

10' x 20' Kit I

Basic Kit Itemization

- 238" w x 31.82" d x 95" h Convex Backwall, with graphic - \$6,373

Basic Kit Wholesale Total \$6,373

Shipping Crate cost \$310

Total estimated Kit & Crate Shipping Weight: 336lbs

Monitor & Floor graphics not included in the kit price.

panoramic™ full visual system

and select an existing Panoramic™ Kit to create a complete display. Since Panoramic™ only shows graphics, your artwork will carry the look and feel of any exhibit! With Panoramic™, the entire display is covered with graphic so your image will be on both sides of the wall.

Our Panoramic™ Kit collection was developed by seasoned exhibit space designers. The collection reflects universal solutions that would work well alone or with existing exhibit spaces. Save time in the design phase



10' x 20' Kit J

Basic Kit Itemization

- 239" w x 43.77" d x 95" h Curved Backwall, w/graphic - \$6,749
- 35" w x 35" d x 42" h Custom Curved Counter with graphic - \$1,762

Basic Kit Wholesale Total \$8,511

As Shown Itemization*

- Two 1" d x 8.25" w x 12" h iPad clam shell holders - \$150

*Total Cost Of Kit As Shown \$8,661

Shipping Crate cost \$620

Total estimated Kit & Crate Shipping Weight: 573lbs



10' x 20' Kit K

Basic Kit Itemization

- 236" w x 48" d x 95" h Curved Backwall & Storage Door with graphic - \$7,342

Basic Kit Wholesale Total \$7,342

Shipping Crate cost \$657

Total estimated Kit & Crate Shipping Weight: 464lbs

Total Cost Of Kit As Shown \$7,342

Monitor & Floor graphics not included in the kit price.

panoramic™ full visual system

Our Panoramic™ Kit collection was developed by seasoned exhibit space designers. The collection reflects universal solutions that would work well alone or with existing exhibit spaces. Save time in the design phase

and select an existing Panoramic™ Kit to create a complete display. Since Panoramic™ only shows graphics, your artwork will carry the look and feel of any exhibit! With Panoramic™, the entire display is covered with graphic so your image will be on both sides of the wall.



20' x 20' Kit A

Basic Kit Itemization

- 192" w x 36" d x 117" h U-Wall w/graphic - \$6,408
- 192" w x 18" d x 117" h Solid Wall w/graphic - \$6,099
- 72" w x 30" d x 42" h Counter w/graphic - \$2,083
- 18" w x 18" d x 117" h 4 Short Towers w/graphic - \$6,722
- 24" w x 18" d x 143" h 4 Tall Towers w/graphic - \$8,206
- Basic Kit Wholesale Total \$29,518**

As Shown Itemization*

- 5 Lights with Adapters - \$592
- 2 Large Monitor Mounts - \$534

*Total Cost Of Kit As Shown \$30,644

Custom Shipping Crate cost \$1,150

Total estimated Kit & Crate Shipping Weight: 1,523lbs

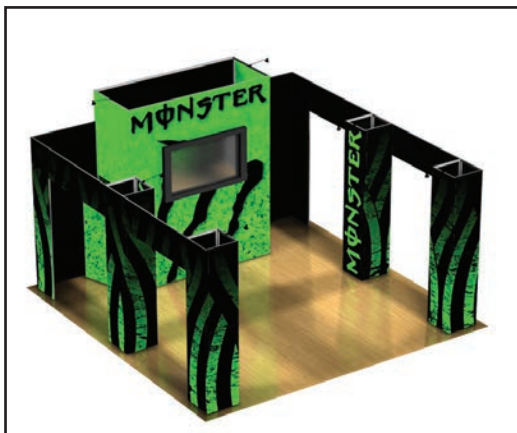

20' x 20' Kit B

Basic Kit Itemization

- 228" w x 324" d x 117" h Backwall, Door & Storage w/graphic - \$5,306
- 112" w x 45.675" d x 143" h Storage Tower w/graphic - \$5,525
- 24" w x 24" d x 117" h 4 Towers w/graphic - \$10,859
- 78" w x 1.575" d x 24" h 4 Header/Arches w/graphic - \$1,331
- Basic Kit Wholesale Total \$23,021**

As Shown Itemization*

- 6 Lights with Adapters - \$444
- 1 Large Monitor Mount - \$267

*Total Cost Of Kit As Shown \$23,732

Custom Shipping Crate cost \$1,314

Total estimated Kit & Crate Shipping Weight: 1,403lbs



20' x 20' Kit C

Basic Kit Itemization

- 48" w x 48" d x 168" h Backwall, Door & Storage w/graphic - \$5,082
- 48" w x 24" d x 168" h 4 Corner Towers w/graphic - \$13,434
- 228" w x 228" d x 24" h 4 Header/Arches w/graphic - \$4,455
- 48" w x 12" d x 42" h 2 Counters w/graphic - \$2,027
- Basic Kit Wholesale Total \$24,998**

As Shown Itemization*

- 4 Large Monitor Mounts - \$1,068

Total Cost Of Kit As Shown \$25,666

Shipping Crates cost \$1,314

Total estimated Kit & Crate Shipping Weight: 1,099lbs

panoramic™ full visual system

Our Panoramic™ Kit collection was developed by seasoned exhibit space designers. The collection reflects universal solutions that would work well alone or with existing exhibit spaces. Save time in the design phase

and select an existing Panoramic™ Kit to create a complete display. Since Panoramic™ only shows graphics, your artwork will carry the look and feel of any exhibit! With Panoramic™, the entire display is covered with graphic so your image will be on both sides of the wall.



20' x 20' Kit D

Basic Kit Itemization

- 48" w x 48" d x 168" h Center Tower, Door & Storage w/graphic - \$5,082
- 48" w x 24" d x 168" h 4 Corner Towers w/graphic - \$13,435
- 228" w x 228" d x 24" h Header/Arches w/graphic - \$5,179
- 48" w x 12" d x 42" h 2 Counters w/graphic - \$2,027

Basic kit Wholesale Total \$25,723

As Shown Itemization*

- 4 Large Monitor Mounts - \$1,068

*Total Cost Of Kit As Shown \$26,791

Shipping Crate cost \$1,314

Total estimated Kit & Crate Shipping Weight: 1,127lbs



20' x 20' Kit E

Basic Kit Itemization

- 96" w x 96" d x 190" h Center Tower w/graphic - \$8,577
- 48" w x 24" d x 168" h 4 Corner Walls w/graphic - \$12,666

Basic Kit Wholesale Total \$21,243

As Shown Itemization*

- 4 Large Monitor Mounts - \$1,068

*Total Cost Of Kit As Shown \$22,311

Shipping Crates cost \$1,314

Total estimated Kit & Crate Shipping Weight: 1,080lbs

Monitor & Floor graphics not included in the kit price.



Pliko is a Tool-Free, Lightweight, Durable SEG Aluminum Display. It is designed to collapse and fold for easy set up and breakdown. Simply unpack and unfold frame, install your SEG graphic, rotate feet and upright your display.

A hard shipping case is included and back side graphics are available by request.

Add Pliko to your exhibit space to get attention and keep it.



**Pliko 108.861" w x 92.861" h
w/Colossus \$2,382
(single-sided graphic*)**

Units not available without graphic

Pricing (includes graphic, unit & case)

Unit Size	Live Area	Print Size	Pliko unit cost	Colossus graphic cost (single-sided graphic*)	Pliko unit w/Colossus cost (single-sided graphic*)
108" w x 92" h	107.875" w x 91.875" h	108.861" w x 92.861" h	\$1,750	\$632	\$2,382

* Add \$632.00 for graphic on backside.

Discounts for Duplicate Images Only The price of the hardware unit is passed on to you at Optima's cost plus shipping and handling and is not discountable. The graphics are discounted based on duplicate volume. To determine the discount % for the multiple units, multiply the price for a quantity of one by the following factors:

Quantity	Discount Factor
2-5	.97
6-10	.96
11-15	.95
16-25	.94
26-50	.93
Above 50	Call for quote

Specifications

Shipping Weight

Unit only 35 lbs.

Unit with Graphic 40 lbs.

Hard Case only 20 lbs.

Total ship weight 60 lbs.

Hard Case Dimension (included)

11" w x 17"d x 66"h

Unit Dimensions

(Open) 108" w x 92" h x 8" d

Unit Color

Black

Foot Color

Black

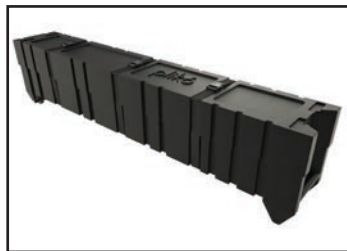

Durable Hard Shipping Case w/Wheels (included)



SEG graphic display



Unit collapses and folds for easy assembly.

panoramic™ iPad Kiosk

Our Panoramic™ Kit collection was developed by seasoned exhibit space designers. The collection reflects universal solutions that would work well alone or with existing exhibit spaces. Save time in the design phase and select an existing Panoramic™ Kit to create a complete display. Since Panoramic™ only shows graphics, your artwork will carry the look and feel of any exhibit! With Panoramic™, the entire display is covered with graphic so your image will be on both sides of the wall.

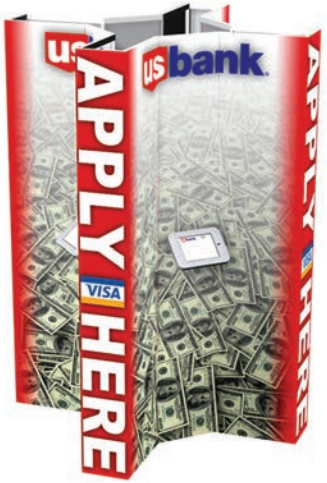

Preliminary Information.

All structures and pricing are subject to change.

Pricing

Total Wholesale Pricing
(As Shown*) \$6,651

Base Kit Itemization:

78.75" w x 78.75" d x 96" h Kiosk with graphic \$6,191

*As Shown Itemization:

4 iPad Clamshells (Holder) Swivel \$460

Optional:

2 - Small Shipping Crates \$620

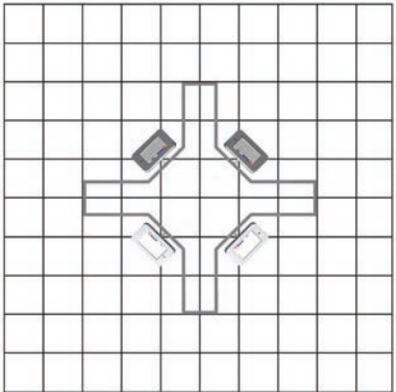

Overhead View

Specifications

Shipping Weight

Unit with Graphic 388 lbs.

Unit with Graphic & 2 small shipping crates 575 lbs.

Unit Dimensions

78.75" w x 78.75" d x 96" h



Kiosk iPad Holder

10/28/2013

Preliminary Information.

All structures and pricing are subject to change.

SEG/Extrusion Systems

panoramic™ Lightboxes

Panoramic Lightboxes give your messages added impact!

Panoramic® lightboxes are the next generation of backlit solutions, increasing the visual impact of your booth when combined with the already known benefits of the classic Panoramic modular system. It offers homogenous lighting and easy to install graphics with silicone edging to streamline your set-up and dismantle.

Panoramic® full visual system is a solution 100% dedicated to your image.



Call For A Quote

Pricing

For Freestanding, Hanging & Wall Mounted Lightboxes call 800-844-8877 for a Quote.

Specifications

Lightbox Size

8ft Panoramic Lightbox:
94”h x 94”w

10ft Panoramic Lightbox:
94”h x 118”w

Transformer

Wattage: 30W - 60W - 150W
Input: AC 170 - 264 v 50/60 Hz
Output: 24V DC
CE / RoHS certified

Graphic Size

8ft Panoramic Lightbox:
Print Size - 94.829”h x 94.829”w
Live Size - 93.843”h x 93.843”w

10ft Panoramic Lightbox:
Print Size - 94.829”h x 118.829”w
Live Size - 93.843”h x 117.843”w

Weight

8ft Panoramic Lightbox Freestanding:
80lbs. (Hardware Only)

10ft Panoramic Lightbox Freestanding:
98lbs. (Hardware Only)

Profiles

Single-Sided Profile (X1) - 3.14” - linear density: 0.94 lbs/Lft

Double-Sided Profile (X2) - 4.72” - 1.38 lbs/Lft
Anodized gray or white

LED Lights

Strips of 3 - 5 LED lights - Cree Brand

Wattage: 2W each LED light

Voltage: 24V DC

Color Temperature: 6,500K (+ -500 K)

MTBF (estimated lifetime) 20,000 hours



Close up view of LED lights inside lightbox

Accessories

Shipping case w/ wheels

Price \$180



Dims:

Outside - 28”w x 52”h x 9.5”d
Inside - 24”w x 48” h x 9”d

2 Shipping cases will be needed for the 8ft Panoramic Ligbox and 3 Shipping cases needed for the 10ft Panoramic Ligbox.

Small Panoramic Crate

Price \$310



Dims: Inside - 21” x 13” x 98”
- Wood construction
- Intended for many shipments



The Alfresco banner stand is designed for outdoor banner applications. The base has a lightweight tank with an easy-fill water or sand opening (water or sand not included). The durable, click-stop mast provides a secure, balanced structure that sets up in minutes and stays put. A bulls-eye locking system in each corner maintains a flat, even shape. The Alfresco can be purchased with or without a graphic. Kaleidoscope Select Sports Mesh is strongly recommended for use on the Alfresco system. Sports Mesh is wind resistant ... perfect for outdoors!



**Alfresco 41" w x 80" h
w/Kaleidoscope Select \$342**



Back Side



Durable, Compact
Soft Carrying
Case
Included

Pricing (includes graphic, unit and carry bag)

Single Sided Graphic Cost (Sports Mesh)

Unit Sizes Available	Graphic Print Sizes	Graphic Final Sizes	Alfresco w/Kaleidoscope Select
16" w, 19" deep	26" - 41" w x 62" - 80" h	24" - 39" w x 60" - 78" h	\$342 (41" x 80")

For a non-standard graphic size, determine the graphic price from the appropriate price list.

Unit w/o graphic cost

Single Sided.....\$160

Wind Slits

(not necessary on Sports Mesh).....\$15 ea

Specifications

Shipping Weight

Unit with Graphic 7 lbs.
(add 2 - 5 lbs. for box and packing)

Unit Color

Grey

Unit

Weight with water in base42lbs.



Do not display your outdoor banners in extreme winds (24-31 mpg or 6ft and higher) and / or thunderstorms. Do not use near overhead wires. Displaying in high winds or near overhead wires may result in property damage, injury or death and any and all existing warranties.



Banshee™

kinetic banner system

The Banshee kinetic banner system is designed to be used indoors or outdoors in most weather conditions. The six unique shapes are designed to give you a variety of options to display your marketing message at Events, Trade Shows, Promotional Marketing and more. The Banshee uses the Pennant fabric process which is a Kaleidoscope Select process that uses full saturation so your message bleeds through and can be seen on both sides of the display. This system has two mechanisms to handle wind: a bearing polypropylene bushing allowing the graphic to rotate out of the wind; but equally important is that the top baton section bends at the same time as the whole unit swivels out of the wind and therefore handles gusts from any direction very well. Banshee is a simple, durable and effective banner system.



**Banshee Medium Concave
w/cross base and
Pennant material \$268**

Pricing (includes graphic & unit)

Unit not available without graphic.

Material Option: Pennant

Small

Size	Final Size	Live Area	Unit Height	Unit Cost	Graphic Cost	Ground Stake*	Total Cost
Concave, Convex, Straight, Angled	21.625"w x 78.75"h	19.125"w x 76.25"h	8.2 ft.	\$36	\$112	\$26	\$174
Drop	29.5"w x 67"h	27" x 64.5"	7.2 ft.	\$36	\$126	\$26	\$188
Rectangle	21.625"w x 90.5"h	19.125"w x 89.5"h	9.2 ft.	\$36	\$125	\$26	\$187

Medium

Size	Final Size	Live Area	Unit Height	Unit Cost	Graphic Cost	Ground Stake*	Total Cost
Concave, Convex, Straight, Angled	23.625"w x 102.375"h	21.125"w x 99.875"h	10.2 ft.	\$46	\$156	\$26	\$228
Drop	37.375"w x 80.75"h	34.875" x 78.25"	8.4 ft.	\$46	\$188	\$26	\$260
Rectangle	23.625"w x 114.188"h	21.125"w x 113.188"h	11.2 ft.	\$46	\$170	\$26	\$242

Large

Size	Final Size	Live Area	Unit Height	Unit Cost	Graphic Cost	Ground Stake*	Total Cost
Concave, Convex, Straight, Angled	31.5"w x 133.875"h	29"w x 131.375"h	13.5 ft.	\$49	\$262	\$26	\$337
Drop	43.188"w x 104.375"h	40.688" x 101.875"	11 ft.	\$49	\$276	\$26	\$351
Rectangle	31.5"w x 151.5"h	29"w x 150.5"h	15 ft.	\$49	\$292	\$26	\$367

* Additional bases are available for the Banshee system on page 0-4.

- Custom hardware widths not available.
- Do not set up the Banshee in winds exceeding 25 mph.

Banshee™

kinetic banner system

Specifications

Shipping Weight unit & graphic:

- Small Banshee - 1.25lbs.
- Medium Banshee - 1.6lbs.
- Large Banshee - 2.25

Banshee Styles

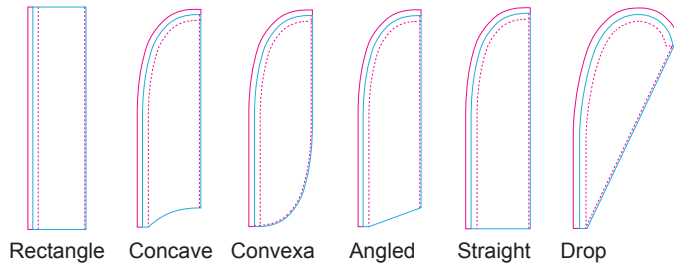

Accessories

Ground stake (outdoor only)

w/bearing to allow swivel
 Cost\$26
 weight: 2.25lbs.
 dimension: 23.5" x 2.5" x 1.5"



Cases (optional)

Small & Medium Banshee
 Green Canvas case
 (w/zipper) \$15.50ea

Large Banshee Green Canvas case
 (w/zipper) \$17.50ea

Cross Base (indoor only)

Cost\$66
 weight: 6.9lbs.
 collapsed: 24" x 3.25" x 3.25"
 open: 40" x 40"



Square Base (indoor only)

Cost\$63
 weight: 20lbs.
 collapsed: 16" x 16"
 open: 16" x 16"



Do not display your outdoor banners in extreme winds (24-31mpg or 6ft and higher) and / or thunderstorms. Do not use near overhead wires. Displaying in high winds or near overhead wires may result in property damage, injury or death and any and all existing warranties.



BASELINE™

The BaseLine is an inexpensive lightweight aluminum "A" frame for use during indoor and outdoor events. The simplicity of the BaseLine system is its greatest appeal. Featuring easy set up and three quick graphic attachment styles.

Display your graphics single or double sided. Graphics can be attached with bungees, velcro (not shown) or a complete fabric cover* of the frame. Choose from two graphic options: Saturn vinyl and Microknit.

For any and all outdoor and indoor events, exhibitions, promotions and shows the BaseLine is a perfect choice.



Do not display your outdoor banners in extreme winds (24-31 mpg or 6ft and higher) and / or thunderstorms. Do not use near overhead wires. Displaying in high winds or near overhead wires may result in property damage, injury or death and any and all existing warranties.



BaseLine Option 1 display w/microknit graphic \$483

Pricing

Option 1-Graphics attached to frame with supplied bungees.

GraphicType	Live Area	Graphic Cost per side	Unit Cost	Total Cost w/two graphics
Microknit	92.125" x 31.125"	\$174	\$135	\$483
Saturn Vinyl	92.125" x 31.125"	\$163	\$135	\$461

BaseLine unit cost..... \$135
(Includes Black canvas carrying bag with red stripe, 8 ground stakes and 24 elastic bungees)

Option 2 - Graphics attached to frame with velcro.

GraphicType	Live Area	Graphic Cost per side	Unit Cost	Total Cost w/two graphics
Microknit	98.5" x 39.75"	\$233	\$135	\$601
Saturn Vinyl	98.5" x 39.75"	\$219	\$135	\$573

Option 3* - Graphics covering the sides and ends of the entire frame. Available with printed ends and without.

GraphicType	Live Area	Graphic Cost w/printed ends	Graphic Cost w/unprinted ends	Unit Cost	Total Cost w/printed ends	Total Cost w/unprinted ends
Microknit	98.5" x 39.75" x 25"d	\$565	\$457	\$135	\$700	\$592

*Option not available with Saturn Vinyl.

Discounts for Duplicate Images Only

The price of the hardware unit is passed on to you at Optima's cost plus shipping and handling and is not discountable. The graphics are discounted based on duplicate volume. To determine the discount for the multiple units, multiply the price for a quantity of one (above) by the following factors:

Quantity	Discount Factor
2-5	.97
6-10	.96
11-15	.95
16-25	.94
26-50	.93
Above 50	Call for quote

Specifications

Unit
weight (without graphic).....17.6 lbs.

set up..... 98.43"w x 38.39"h x 25.2"d
collapsed..... 98.43"w x 38.39"h x 6"d

shipping Box
48" x 6" x 6

- Custom hardware widths not available.
- Do not set up the BaseLine in winds exceeding 20 mph. Due to the uncertainty of wind gusts it is strongly recommended that additional weight or anchoring be added.

Event Tent™ 10' x 10'

The Event Tent is an inexpensive classic canopy style tent. Unlike tents from other suppliers Optima Event Tent canopies and side/backwalls are constructed from Weather Guard™. Weather Guard™ is a water proof material that provides a great shield against sun and rain and is also fire resistant. The Event Tent can be utilized indoors or out to promote your event. With four sides and a sloping canopy your message is visible from all angles and distances. Block out direct sun or wind with full walls or control traffic with half sidewalls.

The Event Tent Weather Guard™ protective canopy cover is made of durable outdoor fade-resistant polyester and has white powder coated steel pop-up support poles. It pops up in only minutes for maximum visibility and shelter. Outfit your tent with full dye sublimated canopy and walls to get maximum brand exposure at your next event!



Do not display your outdoor banners in extreme winds (24-31mpg or 6ft and higher) and / or thunderstorms. Do not use near overhead wires. Displaying in high winds or near overhead wires may result in property damage, injury or death and any and all existing warranties.



10' x 10' Event Tent w/full dyesub
\$1,335 (Base Price + Option 3)

Pricing

Note: Stake & Rope Kit - included

STEP 1: Purchase frame.

Base - 10'x10' frame	\$175
Stake & Rope kit Included with frame price.	

STEP 2: Choose your tent top option.

Option 1 - White top	+115	
Option 2 - Black or Blue (PMS 287) top (PMS colors are approximations)	+125	
Option 3 - dyesub top	+1,185	
If you choose option 1 or 2 above and need Dye-sub Applique or Permalogo graphics see choice A or B below for additional pricing.		
A - Permalogo - Max Size 45" x 25"		
Qty	One Color (Per Press*)	Each additional Color (Per Press*)
1	+75	+50
2-5	+70	+45
6+	+66	+41
B - Dyesub Applique' graphic on sidewalls, backwalls or top - Max size 45"x25"		+95

STEP 3: Additional components (if needed)

Component 4 - White full backwall or sidewall	+95
Component 5 - White full backwall or sidewall with window	+126
Component 6 - dyesub full backwall or sidewall	+595
Component 7 - White half backwall or sidewall	+66
Component 8 - dyesub half backwall	+298
Components 7 & 8 above require side rail hardware at a cost of \$36 each.	

STEP 4: See Outdoor / Events Products Page O-7 for accessories before arriving at a final total.

* Per Press - Any one color graphic that does not exceed the max size = one press. Graphics that exceed the max size or have multiple colors will require additional presses.

Specifications

Tent Weight

without graphics..... 65lbs.

Tent Dimensions

set up..... 10' x 10'

Tent Clearance

At full extension the clearance under the valance is 7ft.

Discounts for Duplicate Images Only

The price of the hardware unit is passed on to you at Optima's cost plus shipping and handling and is not discountable. The graphics are discounted based on duplicate volume. To determine the discount for the multiple units, multiply the price for a quantity of one (above) by the following factors:

Quantity	Discount Factor
2-5	.97
6-10	.96
11-15	.95
16-25	.94
26-50	.93
Above 50	Call for quote

- Custom hardware widths not available.
- Do not set up Event Tents in winds exceeding 25 mph.

Event Tent™ 10' x 20'

The Event Tent is an inexpensive classic canopy style tent. Unlike tents from other suppliers Optima Event Tent canopies and side/backwalls are constructed from Weather Guard™. Weather Guard™ is a water proof material that provides a great shield against sun and rain and is also fire resistant. The Event Tent can be utilized indoors or out to promote your event. With four sides and a sloping canopy your message is visible from all angles and distances. Block out direct sun or wind with full walls or control traffic with half sidewalls.

The Event Tent Weather Guard™ protective canopy cover is made of durable outdoor fade-resistant polyester and has white powder coated steel pop-up support poles. It pops up in only minutes for maximum visibility and shelter. Outfit your tent with full dye sublimated canopy and walls to get maximum brand exposure at your next event!



Do not display your outdoor banners in extreme winds (24-31mpg or 6ft and higher) and / or thunderstorms. Do not use near overhead wires. Displaying in high winds or near overhead wires may result in property damage, injury or death and any and all existing warranties.



10' x 20' Event Tent w/full dyesub
\$2,780 (Base Price + Option 2 & component 3a)

Pricing

Note: Stake & Rope Kit - included

STEP 1: Purchase frame.

Base - 10'x20' frame	\$410
Stake & Rope kit Included with frame price.	

STEP 2: Choose your tent top option.

Option 1 - White top	+175	
Option 2 ** - Black or Blue (PMS 287) top (PMS colors are approximations)	+210	
Option 3 - dyesub top	+2,180	
If you choose option 1 above and need Dyesub Applique' or Permalogo graphics see choice A or B below for additional pricing.		
A - Permalogo - Max Size 45" x 25"		
Qty	One Color (Per Press*)	Each additional Color (Per Press*)
1	+75	+50
2-5	+70	+45
6+	+66	+41
B - Dyesub Applique' graphic on sidewalls, backwalls or top - Max size 45"x25"		+95

STEP 3: Additional components (if needed)

Component 3a - White full backwall	+190
Component 3b - Sidewall	+95
Component 4a - White full backwall with 2 windows	+252
Component 4b - Sidewall with window	+126
Component 5 - 10' dyesub sidewall	+595
Component 6 - 20' dyesub backwall	+1077
Component 7 - White half sidewall	+66
Component 8 - 20' dyesub half backwall	+538.50
Components 7 & 8 above require side rail hardware at a cost of \$36 each.	

STEP 4: See Outdoor / Events Section Page O-7 for accessories before arriving at a final total.

* Per Press - Any one color graphic that does not exceed the max size = one press. Graphics that exceed the max size or have multiple colors will require additional presses.

** There is a 5 Day Lead Time on inventory.

Specifications

Tent Weight
without graphics..... 100lbs.

Tent Dimensions
set up..... 10' x 20'

Tent Clearance
At full extension the clearance under the valance is 7ft.

Discounts for Duplicate Images Only
The price of the hardware unit is passed on to you at Optima's cost plus shipping and handling and is not discountable. The graphics are discounted based on duplicate volume. To determine the discount for the multiple units, multiply the price for a quantity of one (above) by the following factors:

Quantity	Discount Factor
2-5	.97
6-10	.96
11-15	.95
16-25	.94
26-50	.93
Above 50	Call for quote

- Custom hardware widths not available.
- Do not set up Event Tents in winds exceeding 25 mph.

Event Tent™

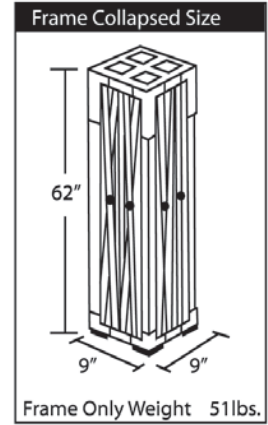
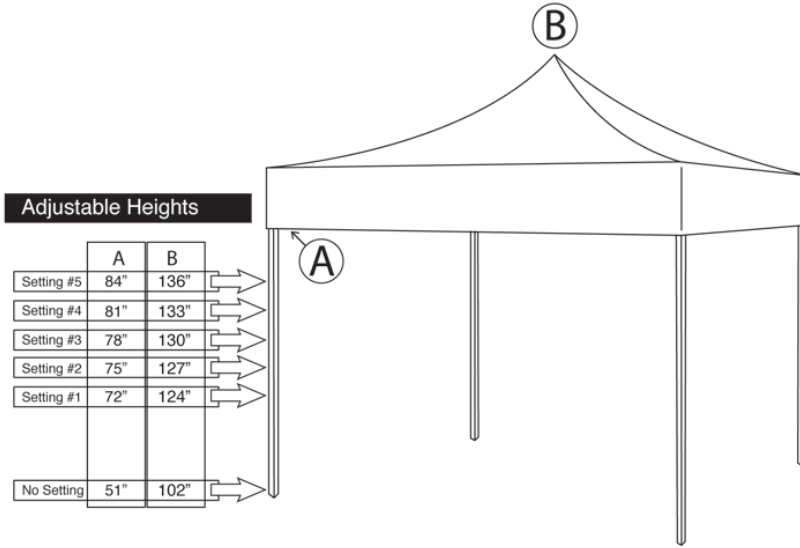

Shipping Weights & Sizes

Item	Weight
Event Tent Frame (boxed)	51 lbs.
Canopy Top, Bag, Stakes	10 lbs.
Carton	5 lbs.
Total kit shipping weight	66 lbs

Shipping Box Size:
66" x 10" x 10"

Event Tent Kit Includes

Qty	Item
1	Event Tent Frame
1	Weather Guard™ Canopy Top
1	Event Tent Stakes

Accessories

Stake (Qty. 4) and Rope Kit
additional or replacement
kit..... \$10 ea.



Anchor Ballasts \$39 ea.



Each Anchor Ballast holds 2.5 gallons and weighs 22 lbs. when full.

Anchor Ballasts covers \$20 ea.
Ballast covers are made with twill fabric.
See page T-4 for available Fabric Colors
in Stock.

Shipping Cases - Only available with the 10' x 10' Event Tent.

Hard case 12" x 72"
w/wheels..... \$140



Soft Case
w/wheels.....\$93



Close up of
soft case
wheels



Side Rail Hardware \$36 ea.

Tent Pole Clamps for Flag - A set of two clamps is needed
to support each flag \$48 for each set of 2 clamps



Event tent
with flag
attached
to pole.

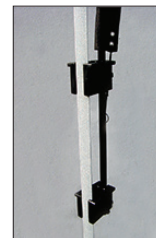

Close Up of
2 clap set
attached to
tent pole.

MediaScreen2 AWD (outdoor)

The Media Screen 2 AWD (All Weather Display) is the outdoor banner stand that carries all the style and features of an indoor premium stand but with tough as nails outdoor hardware. The Media Screen 2 AWD is a double-sided unit tough enough for outdoor weather conditions. The supporting masts and graphics are retracted into the silver-on-chrome base. The unit is designed with a heavy duty base and spring supported mast. Two black padded storage bags are standard with all units.



Do not display your outdoor banners in extreme winds (24-31mpg or 6ft and higher) and / or thunderstorms. Do not use near overhead wires. Displaying in high winds or near overhead wires may result in property damage, injury or death and any and all existing warranties.



MediaScreen 2 AWD
33.25" w x 76" h
w/Kaleidoscope Select \$787

Pricing (includes graphic, unit and carry bag)

Unit Sizes Available	Live Area	Actual Graphic Print Sizes	MediaScreen2 AWD w/Lambda Bright	MediaScreen2 AWD w/Kaleidoscope Select	MediaScreen2 AWD w/Mesa	MediaScreen2 AWD w/Print-on-it
33.5" w	33.25" w x 70" h	33.25" w x 76" h	N/A	\$787	\$805	\$769

• MicroKnit Recycled fabric: Kaleidoscope Select - \$9/sq. ft. - Colossus 4 color - \$8/sq. ft. - Colossus 8 color - \$9/sq. ft.

Units may be purchased without graphic
33.5" Unit\$495

Discounts for Duplicate Images Only -

The price of the hardware unit is passed on to you at Optima's cost plus shipping and handling and is not discountable. The graphics are discounted based on duplicate volume. To determine the discount for the multiple units, multiply the price for a quantity of one (above) by the following factors:

Quantity	Discount Factor
2-5	.97
6-10	.96
11-15	.95
16-25	.94
26-50	.93
Above 50	Call for quote

Specifications

Shipping Weight
33.5" w Unit with Graphic 36.65 lbs.
(add 2 - 5 lbs. for box and packing)

Shipping Box
33.5" w Unit: 10" x 10" x 36"

Unit Color
Matte Silver on chrome



Accessories

Grip Pegs (set of 4 pegs).....\$25
Grip Pegs only available for the MediaScreen 2 All Weather Display - 4 required

The unit is designed with a heavy duty base and spring supported mast to help outdoors in situations where wind gusts below 20 mph are consistent.

Outpost™

The Outpost is a heavy duty outdoor double sided display. It features a tool-free assembly and rugged aluminum steel construction. The dual spring design flexes to help withstand wind gusts. The base can be filled with water or sand for extra stability and has wheels for easy installation and evening storage or for moving indoors after hours. The Outpost is a great display for indoor and outdoor events.



Do not display your outdoor banners in extreme winds (24-31mpg or 6ft and higher) and / or thunderstorms. Do not use near overhead wires. Displaying in high winds or near overhead wires may result in property damage, injury or death and any and all existing warranties.



Outpost w/Lambda Bright graphics (both sides) & unit \$387

Pricing (includes graphic, unit & bag)

Unit not available without graphic.

Lambda Bright

Print Size	Live Area	Graphic Cost single sided	Unit Cost	Total Cost w/graphic on both sides
22.875w" x 32.625"h	22.25"w x 32.5"h	\$91	\$205	\$387

Print-on-it .020 White Styrene

Print Size	Live Area	Graphic Cost single sided	Unit Cost	Total Cost w/graphic on both sides
23.375w" x 33.125"h	22.875"w x 32.5"h	\$32	\$205	\$269

Print-on-it .020 Colored Styrene

Print Size	Live Area	Graphic Cost single sided	Unit Cost	Total Cost w/graphic on both sides
23.375w" x 33.125"h	22.875"w x 32.5"h	\$40	\$205	\$285

Specifications

Shipping Weight

Unit (empty) - 31lbs.

Unit (full) - 110lbs.

Unit Dimensions

29.33"w x 49"h x 24"d

Graphic & Unit (empty)- 33lbs.

- Custom hardware widths not available.
- Do not set up the Outpost in winds exceeding 20 mph.

Discounts for Duplicate Images Only

The price of the hardware unit is passed on to you at Optima's cost plus shipping and handling and is not discountable. The graphics are discounted based on duplicate volume. To determine the discount for the multiple units, multiply the price for a quantity of one (above) by the following factors:

Quantity	Discount Factor
2-5	.97
6-10	.96
11-15	.95
16-25	.94
26-50	.93
Above 50	Call for quote

Rally Banner™

The Rally Banner is designed for outdoor banner displays. The graphic is attached to the frame with multiple secure connections for greater stability. With the ability to adjust the height up to 16' your audience will notice your message from great distances at your next event.



Do not display your outdoor banners in extreme winds (24-31 mpg or 6ft and higher) and / or thunderstorms. Do not use near overhead wires. Displaying in high winds or near overhead wires may result in property damage, injury or death and any and all existing warranties.



Pricing (includes graphic, unit & carry bag)

Unit not available without graphic.

Rally Banner 44" x 145" w/Dacron single sided graphic \$675

Kaleidoscope Select & Colossus (4color)

Graphic Options	Final Size	Live Area	Graphic Cost each	Total Cost w/single sided graphic	Total Cost w/double sided graphic & blocker
Dacron or Weave	44"w x 55"h to 145"h	42"w x 53"h to 143"h	\$354 (44"w x 145"h)	\$675 (44"w x 145"h)	\$1074 (44"w x 145"h)

Unit cost..... \$264

Carry Bag
(2) black canvas..... \$57
(total for canvas bag set)

Discounts for Duplicate Images Only
The price of the hardware unit is passed on to you at Optima's cost plus shipping and handling and is not discountable. The graphics are discounted based on duplicate volume. To determine the discount for the multiple units, multiply the price for a quantity of one (above) by the following factors:

Quantity	Discount Factor
2-5	.97
6-10	.96
11-15	.95
16-25	.94
26-50	.93
Above 50	Call for quote

Specifications

Standard Graphic Size
44"w x 54"h adjustable to 144"h

Shipping Weight
Unit empty - 44 lbs.
Unit empty & Graphic - 55lbs.

Unit Color
Silver & Grey

Unit Dimensions
Collapsed (2 separate pieces)
Base - 34" x 17" x 17"
Poles - 68" x 9" x 5"
Open 45"w x 210"h x 36"d

Unit Footprint
36" x 36"

Accessories

Rally Banner Skirt
DyeSub..... \$315
Pre-dyed skirt..... \$50
Permalogo:
\$105 for a single one color logo
\$70 per logo for each additional logo
\$50 per color for each additional logo



- Custom hardware widths not available.
- Do not set up the Rallybanner in winds exceeding 20 mph.

Ridgeline™

The Ridgeline is an effective message or branding carrier and a super outdoor space definer that can be used to attract attention at any indoor and outdoor event.

Ridgeline is extremely compact when unassembled and portable. An ideal display in all kinds of environments. It's unique spring construction allows the product to virtually unfold itself once you take it out of the bag. Putting it back together is done in a few easy steps - it does not get any easier than that.



Do not display your outdoor banners in extreme winds (24-31mpg or 6ft and higher) and / or thunderstorms. Do not use near overhead wires. Displaying in high winds or near overhead wires may result in property damage, injury or death and any and all existing warranties.



Ridgeline Colossus graphic & unit \$569

Pricing (includes graphic, unit & bag)

Unit not available without graphic.

Graphic Process	Graphic Options	Graphic Cost (main body & ends)	Unit Cost	Total Cost
Kaleidoscope Select & Colossus (4 color)	Microknit & WeatherGuard	\$341	\$185	\$528
Colossus 8 color	Microknit & WeatherGuard	\$384	\$185	\$569

Discounts for Duplicate Images Only

The price of the hardware unit is passed on to you at Optima's cost plus shipping and handling and is not discountable. The graphics are discounted based on duplicate volume. To determine the discount for the multiple units, multiply the price for a quantity of one (above) by the following factors:

Quantity	Discount Factor
2-5	.97
6-10	.96
11-15	.95
16-25	.94
26-50	.93
Above 50	Call for quote



Carry Bag

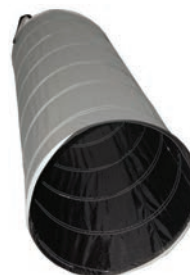

Ridgeline without graphic view



Ridgeline in bag view

Specifications

Shipping Weight

With graphic - 17lbs.
Without graphic- 15lbs.

Unit Dimensions

Collapsed - 26" w x 27" h x 6" d
Open - 24.5" w x 23" h x 79" length (in bag)



- Custom hardware widths not available.
- Do not set up the Ridgeline in winds exceeding 20 mph.

Skyblade™

Sky Blade is a lightweight and portable flag stand perfect for outdoor events. The Sky Blade holds up to 40 mph wind with either the weighted base or ground stake. For higher winds add additional weight. With one or multiple units and three different heights available your message will have exceptional visibility for all to see.



Do not display your outdoor banners in extreme winds (24-31mpg or 6ft and higher) and / or thunderstorms. Do not use near overhead wires. Displaying in high winds or near overhead wires may result in property damage, injury or death and any and all existing warranties.



**Skyblade Super w/Dacron
single sided graphic \$634**

Pricing (includes graphic & unit)

Unit not available without graphic.

Kaleidoscope Select & Colossus (4 color)

Regular Size

Graphic Options <i>Weave not available for double sided</i>	Final Size	Live Area	Single Sided Graphic Cost	Double Sided Dacron Graphic cost w/blocker	Unit w/X Base Cost	Total Cost w/single sided graphic	Total Cost w/double sided Dacron graphic & blocker
Dacron or Weave	40.5"w x 70.75"h	37.75"w x 68.75"h	\$176	\$374	\$273	\$449	\$647

Super Size

Graphic Options <i>Weave not available for double sided</i>	Final Size	Live Area	Single Sided Graphic Cost	Double Sided Dacron Graphic cost w/blocker	Unit w/X Base Cost	Total Cost w/single sided graphic	Total Cost w/double sided Dacron graphic & blocker
Dacron or Weave	40.5"w x 110"h	37.75"w x 108.5"h	\$272	\$577	\$362	\$634	\$939

Giant Size

Graphic Options <i>Weave not available for double sided</i>	Final Size	Live Area	Single Sided Graphic Cost	Double Sided Dacron Graphic cost w/blocker	Unit w/X Base Cost	Total Cost w/single sided graphic	Total Cost w/double sided Dacron graphic & blocker
Dacron or Weave	40.5"w x 149.5"h	37.75"w x 147.5"h	\$365	\$776	\$468	\$833	\$1244

Unit w/Ground Stake Cost / Weight
 Regular..... \$164 / 4.4lbs.
 Super..... \$252 / 6.2lbs.
 Giant..... \$291 / 8lbs.

Unit w/X Base Cost / Weight
 Regular..... \$273 / 22lbs.
 Super..... \$362 / 23.8lbs.
 Giant..... \$468 / 25.6lbs.

Discounts for Duplicate Images Only The price of the hardware unit is passed on to you at Optima's cost plus shipping and handling and is not discountable. The graphics are discounted based on duplicate volume. To determine the discount for the multiple units, multiply the price for a quantity of one (above) by the following factors:

Quantity	Discount Factor
2-5	.97
6-10	.96
11-15	.95
16-25	.94
26-50	.93
Above 50	Call for quote

Skyblade™

● Specifications

Wind Speed Guidelines

Stand Size	X Base	X Base w/ additional weight	Ground Stake	X Base + Snow & Soil Stakes
Regular	30 mph	40 mph	40 mph	40 mph
Super	20 mph	30 mph	40 mph	40 mph
Giant	N/A	20 mph	30 mph	40 mph

● Accessories

Item	Cost	Weight
Additional weight for X Base w/case	\$68	15.5lbs.
X Base (Does not include unit)	\$123	17.6lbs.
Ground Stakes	\$51	2.3lbs.
Snow & Soil Stakes	\$20	5lbs.

Ground Stake



VALET™

Easy to move and set up anywhere, the Valet is perfect for outdoor or indoor use. Great for corporate environments, trade shows, expos, events and more. Just find your perfect location, spread out the dual board hinged display and the Valet will be sure to catch the attention of pedestrians and motorists alike. The Valet comes in two sizes 25" x 45" or 25" x 36". The valet is hinged which makes the double sided features perfect to display multiple messages in high traffic areas! Outdoor signage needs to be stable on windy days or in poor weather conditions. The Valet stays in place and is sturdy enough to use in most applications. When increased weight is desired the Valet can be filled with sand to add 5lbs. more weight per side. Constructed of heavy duty durable plastic for long life, the Valet can take a beating and still look great for years. Graphics can be mounted permanently to the unit. Need replaceable graphics? No problem, the Valet features optional easy to use mounting hardware for easy graphic change out or velcro graphics.



**Valet 25" x 45"
w/Lambda Graphic \$274**

Pricing

Valet unit is not available without graphic.

Lambda: (Options: Bright, Duraflex and Metallic)

Unit Size	Graphic Size	Graphic Cost Each	A-Frame Unit Cost	Total Cost w/graphic on both sides
25" x 45"	23.75" x 36"	\$101	\$72	\$274
25" x 36"	23.75" x 24"	\$74	\$67	\$215

Print-on-it: (Options: .020 Styrene)

Unit Size	Graphic Size	Graphic Cost Each	A-Frame Unit Cost	Total Cost w/graphic on both sides
25" x 45"	23.75" x 36"	\$45	\$72	\$162
25" x 36"	23.75" x 24"	\$40	\$67	\$147

Valet 360:

Unit Size	Graphic Cost	A-Frame Unit Cost	Total Cost w/graphic on both sides
25" x 45"	\$239	\$72	\$311
25" x 36"	\$177	\$67	\$244

- Custom hardware widths not available.
- Do not set up the Valet in winds exceeding 20 mph.

Specifications

Unit Weight

25" x 45" 10 lbs.
25" x 36" 5 lbs.

Unit Optional Hardware:

(for removable signs) Hardware Screws.... \$10
(4 nuts and 4 bolts) Velcro Graphics ... No Charge

Installation options for graphics

- 1" tape perimeter
- Velcro Perimeter
- Well nuts & bolts



Do not display your outdoor banners in extreme winds (24-31mpg or 6ft and higher) and / or thunderstorms. Do not use near overhead wires. Displaying in high winds or near overhead wires may result in property damage, injury or death and any and all existing warranties.



Discounts for Duplicate Images Only
The price of the hardware unit is passed on to you at Optima's cost plus shipping and handling and is not discountable. The graphics are discounted based on duplicate volume. To determine the discount for the multiple units, multiply the price for a quantity of one (above) by the following factors:

Quantity	Discount Factor
2-5	.97
6-10	.96
11-15	.95
16-25	.94
26-50	.93
Above 50	Call for quote

VALET360

Full Fabric Cover Option





Kapow is a great product for quick and easy outdoor advertising.

Your eye catching graphics on the Kapow's two sided A-frame design will grab your audiences attention in both directions.

The unique design of the Kapow makes transportation and assembly simple. The carry bag is the base of the display. Just unhook the graphics from the base, collapse them and put into the circle carry bag and go.



Kapow 79" w x 35" h Medium w/Dacron double sided Graphic \$508

Pricing (includes graphic & unit)

MEDIUM

Kapow Unit Size	Actual Graphic Print Size	Live Area	Kapow w/double sided Kaleidoscope Select Dacron Graphic cost
79" w x 33" h	84.6459" w x 38.5826" h	82" w x 36" h	\$508

Carry Bag w/4 ground stakes included.



LARGE

Kapow Unit Size	Actual Graphic Print Size	Live Area	Kapow w/double sided Kaleidoscope Select Dacron Graphic cost
114.5" w x 39.5" h	114.567" w x 43.307" h	112" w x 40.8" h	\$721

Graphic easily twists for quick set up and break down.



Specifications

Shipping Box

Medium: 37" x 37" x 2"
Large: 46.5" x 46.5" x 2"

Shipping Weight

Medium:
Unit & Graphics - 5.15 lbs
Unit & Graphics in box - 7.61 lbs

Large:
Unit & Graphics - 7.6 lbs
Unit & Graphics in box - 11.3 lbs

Dimensions

Medium:
Open - 79" w x 33" h x 37" d
Collapsed - 37" w x 37" h x 1.5" d

Large:
Open - 114.5" w x 39.4" h x 46" d
Collapsed - 46" w x 46" w x 1.5" d



View of Graphics and Base (carry case) connected.



Do not display your outdoor banners in extreme winds (24-31 mpg or 6ft and higher) and / or thunderstorms. Do not use near overhead wires. Displaying in high winds or near overhead wires may result in property damage, injury or death and any and all existing warranties.



Boulevard Polls for Banners

Boulevard Poles are used for single or double-sided street banners and signs that are typically installed on light or electric poles.

Banners are printed on our 15oz. Blackout Vinyl using our Solv-it! process. See page GS-1 for Banner pricing.

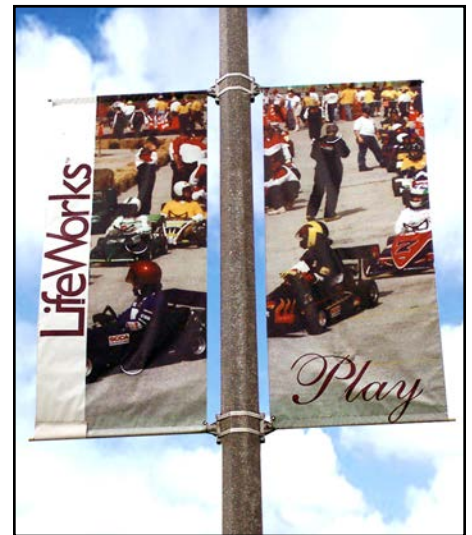

Double Sided Boulevard Poll and Banner.
(Image is printed on both sides of each banner)

Pricing

Poll Size	Price
24" Single	\$67.00 per set
30" Single	\$69.00 per set
24" Double	\$115.00 per set
30" Double	\$120.00 per set
36" & 48" available	Please call for quote

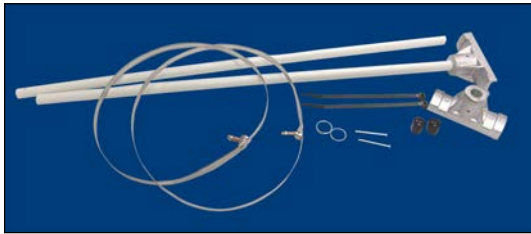

Each set contains: (Shown Above)

- Top Casting (1)
- Bottom Casting (1)
- Rings (2)
- Fiberglass Arms (2)
- Pins (2)
- Rubber Caps (2)
- Stainless Steel Bands (2)
- Nylon Zip (2)



Single Sided
Boulevard Poll
and Banner



Double Sided
Boulevard Poll
and Banner

Image is printed on both sides of each banner.

Barricade Covers

Barricade Covers for Rented Crowd Control/Bike Rack Structures. Make an Eyesore into Opportunity. The simple solution to brand all crowd control barricades, space defining A-Frames and Rented Bike racks. You can easily cover any rented barricade structure and offset event costs by advertising your sponsors information. Create event awareness in photos, TV news cams and Social Media spots.

NOTE: Product sizes vary. Send in dimensions with your order. Optima does not sell the structures only the graphics to cover them. Remember to secure all your structures. Optima Graphics is not responsible for damage or injury to property or individuals.

Optima Graphics does not sell or supply barricades.



(Multiple Barricades shown.)

One 36" h x 96" w doublesided
Barricade with
Weather Guard® graphic \$384

Pricing

Full color Dye Sublimation Cover:
(Weather Guard® material recommended)
Price: \$8 sq/ft

Full color Solv-it 13oz Cover:
Price: \$7 sq/ft

Call for quote on large quantities.

Print Size: 72" h x 96" w (Finished Size: 36" h x 96" w)
Makes a double sided graphic to go over one
barricade. Secure with velcro strips on each side.



Two Barricades shown with graphics.



Close up of Barricades attached with graphics.

NOTE: Product sizes vary. Send in dimensions with your order. Optima does not sell the structures only the graphics to cover them. Remember to secure all your structures. Optima Graphics is not responsible for damage or injury to property or individuals.

Backlits



The 2N1 brings you the best of both worlds. An all inclusive backlit podium or a backlit table top display, and best of all it's easy to use. The 2N1 sets up in 30 seconds and breaks back down just as quickly. The backlit front graphic is complimented by opaque side graphics both in podium and table to applications. When used as a podium the top can support up to 150 lbs safely while the inside shelf stores all your stuff out of site. The top has plenty of space for card readers, monitors, food preparation equipment or products. Electrical cords disappear neatly into the top through a small access hole. More than a podium the 2N1 is a true work station. As a backlit table top display the 2N1 has a unique concave / convex shape that is sure to attract attention. The display fits perfect on a six foot table. Durable, stable, versatile, the 2N1 is perfect for trade shows, retail and food product demonstrations, mobile marketing events, and much more. All inclusive, your display collapses protecting your graphics and easily is rolled to its next location.



2N1 unit w/duratrans front & Lambda Bright side wing panels \$1,269

Pricing

Front Duratrans Graphic	Side Wing Panel - Detachable (Lambda Bright w/velcro)	Side Wing Panel - Direct Print (Print-on-it vinyl)	Side Wing Panel - Detachable (Print-on-it .040 styrene w/velcro)
\$164	\$65ea	\$46ea	\$44ea

NOTE: - For a non-standard graphic size, determine the graphic price from the appropriate price list.
- Custom hardware widths not available.

2N1 UNIT (without graphic)\$975

FOR COUNTER & HEADER

Quantity	Discount Factor
2-5	.98
6-10	.97
11-15	.96
16-25	.95
26-50	.94
Above 50	Call for quote

2N1 unit closed up with wheels



2N1 unit used as a table top display

Specifications

Unit weight
41 lbs.

Unit dimensions
Open34"W x 36"H x 26"D
Closed34"W x 35"H x 9"D

Shelves
Top shelf can hold50lbs.
Inside shelf can hold...60lbs.

Graphic dimensions
Front31.5"W x 33"H
Side Wing Panel
(1"radius corners)15"W x 31"H



AURA™ is a great backlit solution for any environment. Stable and stylish free-standing aluminum extrusion frame fits in perfectly with any existing display. Add one or multiple AURA™ standing lightboxes to 10x10, 10x20 or island trade show spaces. The AURA™ is perfect for permanent installations and portable enough for easy transport in trade show applications. The round sides of this vertical frame have a far more finished and purposeful shape than typical exposed frames. Universal appeal of the frame is eclipsed by the stunning double sided backlit fabric graphics. The brilliance of Trifab dye sublimated graphics is second to none. The deep saturation and expanded pigment range of this process and material combo brings your image to life. Backlighting from the AURA™ lightbox brings out the brilliant color and fine detail of your high-quality images. Photos, text and colorful design elements all benefit from Dye-Sublimated backlit Trifab graphics. The optional rigid graphic header can be printed with a full image on both sides. The header makes a great topper that enhances your message. Create remarkable displays within 10', 20' inlines or larger island displays.

Easy change-out of the fabric, so easy that you could have a new message every day of the show! SEG (silicon edge graphics) means message updates ship to your destination in an envelope.

AURA™ 2472

Double sided standing light box
 Frame (w/ 4 lights) \$708
 Graphics (2) \$168
Total Price \$876
 (cardboard shipping container included)

Header graphic available

Dimensions

Open: 24" w x 72" h
 Collapsed: 48.25" w x 7.5" d x 24.75" d



AURA™ 4272

Double sided standing light box
 Frame (w/ 4 lights) \$737
 Graphics (2) \$320
Total Price \$1,057
 (cardboard shipping container included)

Header graphic available

Dimensions

Open: 42" w x 72" h
 Collapsed: 48.25" w x 7.5" d x 24.75" d



AURA™ 4886

Double sided standing light box
 Frame (w/ 4 lights) \$738
 Graphics (2) \$458
 Optional Header Graphic \$61
Total Price \$1,257
 (cardboard shipping container included)

Dimensions

Open: 48" w x 86" h
 Collapsed: 48.25" w x 7.5" d x 24.75" d



Shown with optional Header graphic

Header Graphics - Print Process: Print-on-it or Lambda on 1/4" black or white sintra. (Price below based on double sided direct print to sintra.)

AURA™ 2472

Size: 18" w x 10" h \$39ea

AURA™ 4272

Size: 32" w x 10" h \$54ea

AURA™ 4886

Size: 39" w x 10" h \$61ea

Frame Schematics:

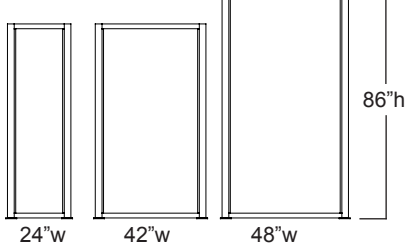

Hex key tool supplied for frame assembly.



AURA unit shown broken down and packed in supplied cardboard shipping carton.

Specifications

Main Graphic

Print Process: Dyesub / Material: Trifab

AURA™ 2472

Final Size: 19.4235" w x 69.3124" h
 Live Area: 18.4375" w x 68.25" h

AURA™ 4272

Final Size: 36.9374" w x 69.3124" h
 Live Area: 35.875" w x 68.25" h

AURA™ 4886

Final Size: 44.0485" w x 83.2985" h
 Live Area: 43.0625" w x 82.3125" h

Lights (qty. 4)

4-34.5" long T5 Fluorescent lights come with each frame and are included in the total price.

Additional Frame Dimensions

- Frame is 5" deep x sizes mentioned above.
- Feet are 22" long and extend 8.5" front and back of frame.

Weights (includes graphic, lights & frame)

AURA™ 2472
 In carton ... 56lbs. / In case ... 71lbs.
AURA™ 4272
 In carton ... 60lbs. / In case ... 75lbs.
AURA™ 4886
 In carton ... 66lbs. / In case ... 81lbs.

Accessories



Side Panel Clamp
 Price \$15 each
 Size: 1.5" w x 1.5" h
 Color: Silver

Optional Hard Shipping Case

(Black w/ wheels)
 Price \$180.00
 Wt (empty) 25lbs.

Dimension:
 (Outside) 28" w x 52" h x 9.5" d
 (Inside) 24" w x 48" h x 9" d

Cardboard Shipping Carton

Wt. (empty) 10lbs.
 48.25" w x 7.5" d x 24.75" d



Swap cardboard shipping carton for hard shipping case for \$175.

LED Light Frame

The LED light frame is a great product for displaying your backlit graphics. This aluminum indoor frame can be mounted to a walls and other structures. The frame is designed for easy graphic change.



**LED Light Frame Large
w/Lambda Duratrans \$555**

Pricing (includes graphic & unit)

Unit not available without graphic.

Medium

Graphic Options	Unit Size	Graphic Live Area	Graphic Final Size	Replacement Graphic Cost	Total Cost
Lambda Duratrans	25" x 30.5" x 2"	21.75" x 27.625"	23" x 29"	\$85	\$443
Trifab	25" x 30.5" x 2"	21.75" x 27.625"	23" x 29"	\$38	\$398

Large

Graphic Options	Unit Size	Graphic Live Area	Graphic Final Size	Replacement Graphic Cost	Total Cost
Lambda Duratrans	27" x 38.5" x 2"	24" x 36"	25.25" x 37.375"	\$111	\$555
Trifab	27" x 38.5" x 2"	24" x 36"	25.25" x 37.375"	\$53	\$497

Discounts for Duplicate Images Only

The price of the hardware unit is passed on to you at Optima's cost plus shipping and handling and is not discountable. The graphics are discounted based on duplicate volume. To determine the discount for the multiple units, multiply the price for a quantity of one (above) by the following factors:

Quantity	Discount Factor
2-5	.97
6-10	.96
11-15	.95
16-25	.94
26-50	.93
Above 50	Call for quote

Specifications

Unit Dimensions

Medium: 25" x 30.5" x 2"
Large: 27" x 38.5" x 2"

Shipping Weight

Medium: 16.5lbs.
Large: 20.1lbs

Unit Color

Silver

Shipping Box

30" x 3" x 46.5"

- Custom hardware widths not available.

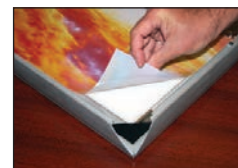

Unhinge frame sides and insert graphic.

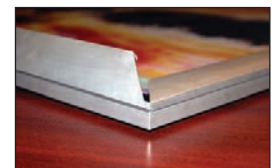

Once graphic is in place press frame sides closed.

Power Panel TM

The Power Panel is a mural type panel which is produced at a larger width. When the Power Panel is placed on a curved or flatwall pop-up display, it bows outward and creates a large backlit graphic. A reflector panel is attached behind the Power Panel to create a lightbox (the space between the graphic and the reflector). High intensity, fluorescent lights are hung within this lightbox. The effect is a big, bold, backlit image with no structural elements of the display interfering with the image.



Standard Pop Up Lambda Duratrans Power Panel Kit \$649
(Mural Panels not included)

Pricing

Unit Options	Lamda Duratrans Power Panel Cost	Reflector Panel Cost	Light Bulb Fixture Cost	Total Cost
Standard Pop Up	\$427	\$105	\$117 (One - 34" & Two - 22" lightbars, 6' power cord & "J" hooks)	\$649
6' Table Top	\$299	\$70	\$83 (One - 34" & One - 22" lightbars, 6' power cord & "J" hooks)	\$452

Replacement Light Bulbs

22" \$34
34" \$42

Quantity Discount - All quantity pricing is based on duplicate images.

Qty.	Power Panel Kits	Power Panels Only
2 - 4	7.5%	15%
5 - 10	10%	20%
> 10	Call for a quote	

Specification

Power Panel Dims
34" x Normal panel height

Reflector Panel Dims
30" x Normal panel height

Accessories

Shipping Cases "O" Case 50.75"
Price\$120

"P" Case 38"
Price\$175

"O" Case 39.5"
Price\$115



Ultimate™ Backlit Header System

The Ultimate is a patented backlit header system that fits ANY curved pop-up display. With only four parts and magnet-to-magnet connection, the frame unfolds and quickly snaps together. Just roll the header onto the frame and attach it to the display. The result is a frame structure that virtually becomes invisible – all you see is the graphic! Because it is universal to all curved pop-ups, it is a great option for adding a backlit header for an easy refurbishment or for display brands you do not carry.



10' Ultimate frame Backlit with Lambda Duratrans graphic and two light bars \$469

Pricing

Frame Sizes	Graphic size	Graphic Live Area	Traditional Graphic w/logo	Traditional Graphic w/copy only	Lambda Duratrans Graphic	Traditional Graphic Total Cost*	Lambda Graphic Total Cost*
8'	83.5" x 15"	72" x 13"	\$274	\$234	\$188	\$481	\$435
10'	106" x 15"	92" x 13"	\$295	\$255	\$222	\$502	\$469

* Total Cost is discounted. Cost includes graphic, ultimate frame & 2 light bars with 3 bulbs each.

Light bars (3 ceramic sockets for use with incandescent lights, ETL and UL approved for use in all convention halls, 22" x 2" x 3" storage size, 100 volts max per socket and a 3 prong plug with heavy duty wiring.)

Price (2) bars\$98

Light bulb packs (with foam packing) (6) bulbs\$20

Ultimate Frame
8' or 10' frame\$195

Specification

Ultimate Frame Weight
8' Frame6.75lbs.
10' Frame7.25lbs.

Ultimate Frame Dimension
(when stored)
8' & 10' Frame3.5" x 4.5" 30.5"

- For Traditional Headers, add \$20 for each additional opaque color and \$40 for each additional translucent color.
- For duplicate pricing, please call for a quote.
- For custom sizes call for quote.



Lambda Duratrans Option

The brilliance of Lambda Duratrans graphics are second to none. Backlighting from the AURA™ light box in combination with the high quality of Lambda Duratrans graphics brings out the brilliant color and fine detail of your high-quality images. Photos, text and colorful design elements all benefit from this combination. Optional rigid graphic side panels cut to custom shapes can be added to both sides to enhance your message and create remarkable displays.

AURA™ 2472

- Double sided standing light box
- Frame (w/ 4 lights) \$708
- Lambda Graphics (2) \$400
- Hardware for Graphics \$180
- Side Panels (4) \$212
- Total Price \$1,500**

(cardboard shipping container included)

Dimensions

- Open: 24" w x 72" h
- Collapsed: 48.25" w x 7.5" d x 24.75" d



Shown with optional Side Panels

AURA™ 4272

- Double sided standing light box
- Frame (w/ 4 lights) \$737
- Lambda Graphics (2) \$640
- Hardware for Graphics \$216
- Side Panels (4) \$212
- Total Price \$1,805**

(cardboard shipping container included)

Dimensions

- Open: 42" w x 72" h
- Collapsed: 48.25" w x 7.5" d x 24.75" d

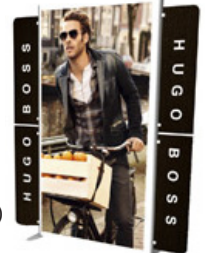

Shown with optional Side Panels

AURA™ 4886

- Double sided standing light box
- Frame (w/ 4 lights) \$738
- Lambda Graphics (2) \$894
- Hardware for Graphic \$252
- Side Panels (4) \$236
- Total Price \$2,120**

(cardboard shipping container included)

Dimensions

- Open: 48" w x 86" h
- Collapsed: 48.25" w x 7.5" d x 24.75" d



Shown with optional Side Panels

Side Panels - 2 clamps recommended per side panel. Print Process: Print-on-it on 1/4" black or white sintra. (Price below based on double sided direct print to sintra with two clamps.)

AURA™ 2472 & AURA™ 4272

- Size: 12" w x 32" h \$53 ea
- Price included two clamps

AURA™ 4886

- Size: 12" w x 40" h \$59 ea
- Price included two clamps

Frame Schematics:

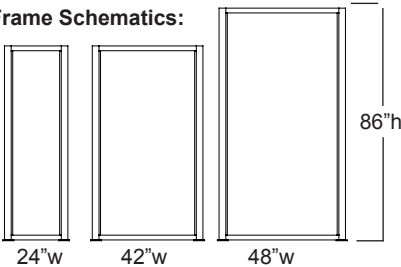

AURA unit shown broken down and packed in supplied cardboard shipping carton.

Specifications

Main Graphic Size:

AURA™ 2472
Final Size: 19" w x 68.125" h

AURA™ 4272
Final Size: 36" w x 68.125" h

AURA™ 4886
Final Size: 43.1255" w x 82.25" h

Lights (qty. 4)
4-34.5" long T5 Fluorescent lights come with each frame and are included in the total price.

Additional Frame Dimensions

- Frame is 5" deep x sizes mentioned above.
- Feet are 22" long and extend 8.5" front and back of frame.

Weights (includes graphic, lights & frame)

- AURA™ 2472**
In carton ... 56lbs. / In case ... 71lbs.
- AURA™ 4272**
In carton ... 60lbs. / In case ... 75lbs.
- AURA™ 4886**
In carton ... 66lbs. / In case ... 81lbs.



Hex key tool supplied for frame assembly.

Accessories



Side Panel Clamp
Price \$15 each
Size: 1.5" w x 1.5" h
Color: Silver

Optional Hard Shipping Case

(Black w/ wheels)
Price \$180.00
Wt (empty) 25lbs.

Dimension:
(Outside) 28" w x 52" h x 9.5" d
(Inside) 24" w x 48" h x 9" d

Cardboard Shipping Carton

Wt. (empty) 10lbs.
48.25" w x 7.5" d x 24.75" d

Swap cardboard shipping carton for hard shipping case for \$175.





VBurst Fabric Curved Pop-ups are now available with a backlighting kit! Convenience, functionality and good looks make VBurst the smart choice for event media backdrops and trade shows. Nothing highlights a message like the power of back-

lighting. Unlike competitive backlit fabric backwalls, the VBurst light kit is a simple, easy-to-use solution...no fussing with unruly or broken fabric light walls. Other systems are clunky and complicated, VBurst keeps it simple.

With the VBurst Backlit kit, simply hang the three or four light bars, apply a separate fabric backwall cover and plug it in. The backwall velcro attaches to the side of the frame and the front fabric graphic endcaps attach to the backwall at the back hub. The result is a clean and professional looking system that is easy to set-up and easy to pack. The front fabric graphic with endcaps is printed with HD Dye Sublimation on backlit material.

When you need a backlit media wall, want to highlight your marketing message or just want to bring your image to life through the power of light, look no further - order a VBurst Backlit Fabric Pop-up!

3x3 Curved Frame



Price As Shown* \$1,918

Kit Itemization



Backlighting brings your Image to Life!

*As Shown Details:

- HD Dye Sub Fabric Graphic w/ Endcaps
- One 3x3 curved frame
- One case
- One case-to-counter conversion kit
- Counter fabric graphic
- Counter blotter (writing surface)
- Backlit light kit
- 102" w x 87.75" h Unprinted fabric backcover
- Fits 10'x10' Space



Add a Portable Steamer for \$58

Shipping Weight: 60 lbs. (Includes Steamer)



Light kit on 3x3 8ft. frame.



Light kit hanging on frame.



Fabric backcover and front graphic installation.



VBurst Fabric Curved Pop-ups are now available with a backlighting kit! Convenience, functionality and good looks make VBurst the smart choice for event media backdrops and trade shows. Nothing highlights a message like the power of backlighting. Unlike competitive backlit fabric backwalls, the VBurst light kit is a simple, easy-to-use solution...no fussing with unruly or broken fabric light walls. Other systems are clunky and complicated, VBurst keeps it simple.

With the VBurst Backlit kit, simply hang the three or four light bars, apply a separate fabric backwall cover and plug it in. The backwall velcro attaches to the side of the frame and the front fabric graphic endcaps attach to the backwall at the back hub. The result is a clean and professional looking system that is easy to set-up and easy to pack. The front fabric graphic with endcaps is printed with HD Dye Sublimation on backlit material.

When you need a backlit media wall, want to highlight your marketing message or just want to bring your image to life through the power of light, look no further - order a VBurst Backlit Fabric Pop-up!

4x3 Curved Frame



Price As Shown* \$2,230

Kit Itemization



Backlighting brings your Image to Life!

***As Shown Details:**

- HD Dye Sub Fabric Graphic w/ Endcaps
- One 4x3 curved frame
- One case
- One case-to-counter conversion kit
- Counter fabric graphic
- Counter blotter (writing surface)
- Backlit light kit and fabric backcover
- 129"w x 87.75"h Unprinted fabric backcover
- Fits 10'x10' Space

Shipping Weight: 60 lbs. (Includes Steamer)



Add a Portable Steamer for \$58



Light kit on 3x3 8ft. frame.



Light kit hanging on frame.



Fabric backcover and front graphic installation.



VBurst Fabric Curved Pop-ups are now available with a backlighting kit! Convenience, functionality and good looks make VBurst the smart choice for events and trade shows. Nothing highlights a message like the power of backlighting. Unlike the competition, the VBurst light kit is a simple, easy-to-use solution... no fussing with unruly or broken fabric light walls. Other systems are clunky and complicated, VBurst keeps it simple.

With the VBurst Backlit kit, simply hang the light bars, apply a separate fabric backwall cover and plug it in. The backwall velcro attaches to the side of the frame and the front fabric graphic endcaps attach to the backwall at the back hub. The result is a clean and professional looking system that is easy to set-up and easy to pack. The front fabric graphic with endcaps is printed with HD Dye Sublimation on backlit material.

When you need a backlit table top, want to highlight your marketing message or just want to bring your image to life through the power of light, look no further - Get a 2x2 Curved VBurst Backlit Fabric Pop-up!

2x2 Curved Frame



Price As Shown* \$931
Table throw not included.

Kit Itemization

- *As Shown Details: (Fits 10'x10' Space)**
- 2x2 curved VBurst frame with HD Dye Sub Fabric Graphic w/ Endcaps \$631
- Backlit light kit \$170
- Unprinted fabric backcover (102"w x 87.75"h) \$130
- ToTal Cost\$931**



Backlighting brings your Image to Life!

Shipping Weight: 35 lbs. (Includes Steamer) *Table throw not included.*

Add a Portable Steamer for \$58



Light kit hanging on frame.



Inatallation of fabric backcover and front graphic at end cap.

Backlits



The VBurst 3x3 Flat BACKLIT is the only pop up backlit on the market that does not show hub shadows on the center of the graphic face. This process is so revolutionary that the product is patent pending.

Convenience, functionality and good looks make VBurst backlits the smart choice for events and trade shows. Unlike the competition, the VBurst light kit is a simple, easy-to-use solution... no fussing with unruly or broken fabric light walls. Other systems are clunky and complicated, VBurst keeps it simple.

When you need a backlit for your 10' x 10' space, want to highlight your marketing message or just want to bring your image to life through the power of light, look no further - Get a 3x3 Flat VBurst Backlit Fabric Pop-up!



3x3 Flat Backlit w/front dyesub & back unprinted graphics and light kit \$1,516

Pricing

- VBurst 3x3 backlit frame \$300
- Light Kit & Unprinted back graphic..... \$493
- Dye sub front Graphic w/endcaps \$723

Total \$1,516



Light kit hanging on frame.



Fabric backcover and front graphic installation.



Back view of light kit

Specifications

Graphic Specifications:

- Dye sub Front ... 114.5" x 88"
- Unprinted Back ... 93" x 88"

Lights:

- Aluminum light hooks (3 per light kit)
- 34" T5 flourescent lights (6 lights per light kit)

3x3 Backlit Frame:

- Open ... 88 x 88 x 12.5
- Collaped ... 12 x 12 x 32

Shipping Weight:

- 3x3 frame only 20 lbs.
- 3x3 frame,graphics and light kit 35 lbs.

Accessoriess

Cover for case to counter conversion	Draped Cover	Form Fitted Cover
With dyesub applique	\$175	NA
With 1 color Perma Logo	\$145	NA
With full dyesub 4 color	\$250	\$250
With full dyesub 8 color	\$270	\$270
Plain solid color cover	\$70	NA

Shipping Case

VBurst Case 38.5"h x 27"w x 15.5"d (including space in the top) \$160

- ABS Counter top
- Blotter (optional) \$10

Total Case to Counter Conversion kit cost \$170



Form Fitted Cover



Draped Cover

Backlits



The VBurst 4x3 Flat BACKLIT is the only pop up backlit on the market that does not show hub shadows on the center of the graphic face. This process is so revolutionary that the product is patent pending.

Convenience, functionality and good looks make VBurst backlits the smart choice for events and trade shows. Unlike the competition, the VBurst light kit is a simple, easy-to-use solution... no fussing with unruly or broken fabric light walls. Other systems are clunky and complicated, VBurst keeps it simple.

When you need a backlit for your 10' x 10' space, want to highlight your marketing message or just want to bring your image to life through the power of light, look no further - Get a 4x3 Flat VBurst Backlit Fabric Pop-up!



4x3 Flat Backlit w/front dyesub & back unprinted graphics and light kit \$1,919

Pricing

- VBurst 4x3 backlit frame \$372
- Light Kit & Unprinted back graphic..... \$635
- Dye sub front Graphic w/endcaps \$912
- Total \$1,919**



Light kit hanging on frame.



Fabric backcover and front graphic installation.



Back view of light kit

Specifications

Graphic Specifications:

- Dye sub Front ... 143.375" x 88"
- Unprinted Back ... 121.5" x 88"

Lights:

- Aluminum light hooks (4 per light kit)
- 34" T5 flourescent lights (8 lights per light kit)

4x3 Backlit Frame:

- Open ... 117 x 88 x 12.5
- Collaped ... 15 x 12 x 32

Shipping Weight:

- 4x3 frame only 23 lbs.
- 4x3 frame,graphics and light kit 45 lbs.

Accessories

Cover for case to counter conversion	Draped Cover	Form Fitted Cover
With dyesub applique	\$175	NA
With 1 color Perma Logo	\$145	NA
With full dyesub 4 color	\$250	\$250
With full dyesub 8 color	\$270	\$270
Plain solid color cover	\$70	NA

Shipping Case

VBurst Case 38.5"h x 27"w x 15.5"d (including space in the top) \$160

ABS Counter top Blotter (optional) \$10

Total Case to Counter Conversion kit cost \$170



Form Fitted Cover



Draped Cover

xpressions[®] LED LIGHTBOX

Pull your Xpressions@SNAP display from its case and pop it up! A complete display in less than a minute. But wait, what's this? One more step? Plug it in? That's right, when you outfit your Xpressions@SNAP!™ display with one or more LED LightBoxes there is one more simple step!



Xpressions® has been turning heads, pulling in booth traffic and defining event spaces all in a complete hassle-free package since its debut. Now add the power of light to add attention at trade shows and create ambiance at events.

Your display remains hassle-free as the LED LightBox is already installed on the frame.

Snap 1x3 w/Lightbox

- Frame & Graphics \$530
 - 1 x 1 skin (3)
- 50 watt halogen lights (1) \$59
- LightBox (2) \$510
- Total Price \$1,099**

**Total Price with two optional
Backlit graphic skins* \$1,119**

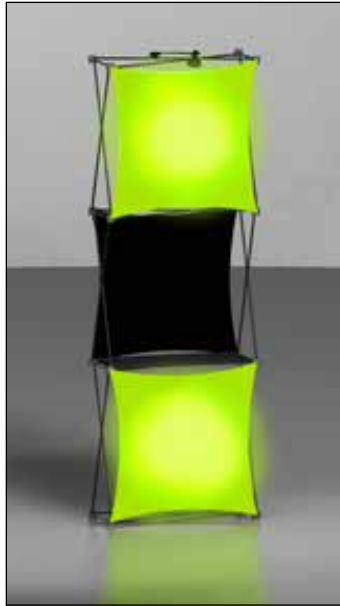

Dimensions

Open: 32.25"W x 94"H x 12.75"D
Closed: 3.5"W x 7"L x 33.75"H

Kit Weight

25 lbs.

Snap 2x3 w/Lightbox

- Frame & Graphics \$1,050
 - 1 x 1 skin (6)
- 50 watt halogen lights (1) \$118
- LightBox (2) \$510
- Total Price \$1,678**

**Total Price with two optional
Backlit graphic skins* \$1,698**

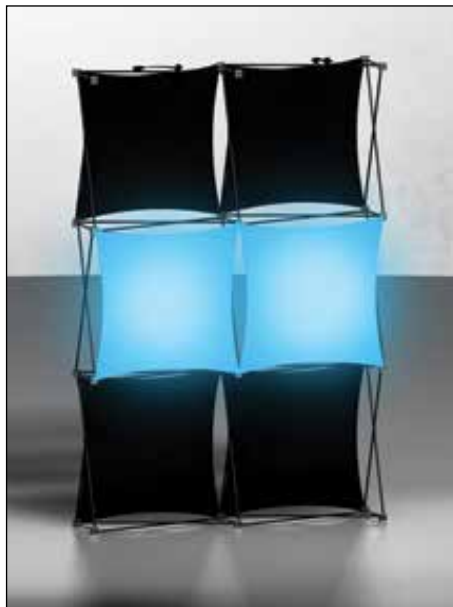

Dimensions

Open: 63"W x 94"H x 12.75"D
Closed: 6"W x 7"L x 33.75"H

Kit Weight

33 lbs.

* Backlit Skin only available as 1x1 - It is recommended that the backlit skin is removed from frame during storage and placed on the supplied cardboard core to avoid wrinkles. Shipping the skin on the supplied cardboard core is also recommended.

xpressions[®]

LED LIGHTBOX

Pull your Xpressions@SNAP display from it's case and pop it up! A complete display in less than a minute. But wait, what's this? One more step? Plug it in? That's right, when you outfit your Xpressions@SNAP!™ display with one or more LED LightBoxes there is one more simple step!

Xpressions® has been turning heads, pulling in booth traffic and defining event spaces all in a complete hassle-free package since its debut. Now add the power of light to add attention at trade shows and create ambiance at events.

Your display remains hassle-free as the LED LightBox is already installed on the frame.

HIGHLIGHT YOUR MESSAGE OR BRAND!

Snap 3x3M w/Lightbox

- Frame & Graphics \$1,558
 - 1 x 1 skin (9)
- LightBox (1) \$255
- Total Price \$1,813**

**Total Price with one optional
Backlit graphic skin* \$1,823**



Dimensions

Open: 93.5"W x 94"H x 12.75"D
Closed: 7"W x 7"L x 33.75"H

Kit Weight

42 lbs.

CREATE BACKDROPS AND ENVIRONMENTS!

Snap 3x3 w/Lightbox

- Frame & Graphics \$1,558
 - 1 x 1 skin (9)
- 50 watt halogen lights (3) \$177
- LightBox (5) \$1,275
- Total Price \$3,010**

**Total Price with five optional
Backlit graphic skins* \$3,060**



Dimensions

Open: 93.5"W x 94"H x 12.75"D
Closed: 7"W x 7"L x 33.75"H

Kit Weight

42 lbs.

CHANGE YOUR MESSAGE OR COLOR EVERYDAY OF THE SHOW!

* Backlit Skin only available as 1x1 - It is recommended that the backlit skin is removed from frame during storage and placed on the supplied cardboard core to avoid wrinkles. Shipping the skin on the supplied cardboard core is also recommended.

xpressions[®] CONNEX[™]

1x3 LED Lightboxes

Xpressions@CONNEX™ transforms the Xpressions@SNAP™ pop-up into an exciting modular display system perfect for trade show or event environments. The key to unlocking your creativity is a simple innovation to the Xpressions@SNAP™ frame: a simple clip on the hub and the addition of a trapezoid and square connecting shelf along with the original rectangular shelf.

Connecting the frames at different angles or in straight lines adds yet another dimension to the Xpressions® exhibit. Dynamic connecting skins are used in combination with square, trapezoid or rectangular connecting shelves to create dramatic inline spaces, concave and convex configurations. Even create octagon islands for events. Add LED lightboxes to highlight your message!

Xpressions CONNEX Power Play 1 LED Lightbox

- Four 1x3 Xpressions@SNAP!™ frames & graphics..... \$2,340
- Two Rectangular CONNEX shelves..... \$84
- One Rectangular shelves..... \$168
- Two Trapezoid shelves..... \$88
- Hourglass Thread skins..... \$251 (c)
- Three Lights..... \$177
- One 1x3 LED lightbox & graphic..... \$1,031 (c)

Wholesale Total \$4,013

With optional Premium Backlit skins - Wholesale Total \$4,038

(c) Connector Skin

Shipping Cases

Fits in 2 Xpressions Shipping Cases. Add for \$288

Wholesale Total w/Cases \$4,301

Display Dimensions: 123" w x 47.5" d x 94" h

Shipping Weight: 43.5lbs. Add 2-5lbs for box & packing

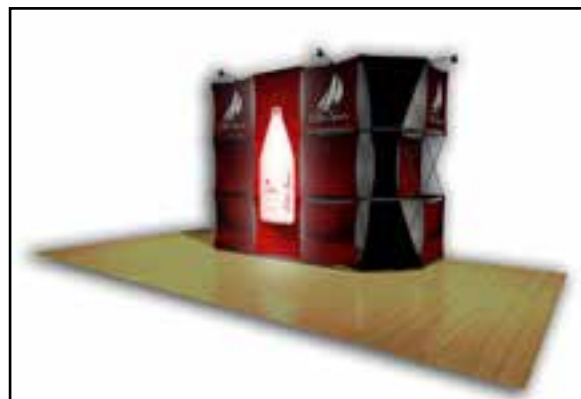

Xpressions CONNEX Power Play 2 LED Lightbox

- Four 1x3 Xpressions@SNAP!™ frames & graphics..... \$2,340
- Four Rectangular CONNEX shelves..... \$168
- Four Rectangular shelves..... \$168
- Two Lights..... \$118
- Two 1x3 LED lightboxes & graphics..... \$2,062 (c)

Wholesale Total \$4,856

With optional Premium Backlit skins - Wholesale Total \$4,906

(c) Connector Skin

Shipping Cases

Fits in 2 Xpressions Shipping Cases. Add for \$288

Wholesale Total w/Cases \$5,194

Display Dimensions: 190" w x 13" d x 94" h

Shipping Weight: 43.5lbs. Add 2-5lbs for box & packing

Xpressions CONNEX Power Play 3 LED Lightbox

- Four 1x3 Xpressions@SNAP!™ frames & graphics..... \$2,340
- Six Rectangular CONNEX shelves..... \$252
- Four Rectangular shelves..... \$168
- Four Lights..... \$236
- Three 1x3 LED lightboxes & graphics..... \$3,093 (c)

Wholesale Total \$6,089

With optional Premium Backlit skins - Wholesale Total \$6,164

(c) Connector Skin

Shipping Cases

Fits in 2 Xpressions Shipping Cases. Add for \$288

Wholesale Total w/Cases \$6,377

Display Dimensions: 218" w x 13" d x 94" h

Shipping Weight: 43.5lbs. Add 2-5lbs for box & packing



pliko™ Backlit

The Pliko has been upgrade by having each unit come with lighting already included on it. You can now choose to backlit your message or not with one display.

It is a Tool-Free, Lightweight, Durable SEG Aluminum Display. It is designed to collapse and fold for easy set up and breakdown. Simply unpack and unfold frame, Install your SEG graphic, rotate feet and upright your display. A hard shipping case is included in the price.

Add Pliko Backlit to your exhibit space to get attention and keep it!



Pliko backlit w/Colossus printed front & unprinted back graphic cost \$3,098

Pricing (includes graphic, unit & case)

Unit Size	Live Area	Print Size	Pliko backlit unit cost	Colossus printed front single sided graphic cost	Colossus unprinted back graphic cost	Pliko backlit w/Colossus printed front & unprinted back graphic cost
108"w x 92"h	107.875"w x 91.875"h	108.861"w x 92.861"h	\$2,150	\$632*	\$316**	\$3,098

* Add an additional \$632.00 for printed graphic on backside.

** Needed if you use the Pliko as a backlit display. If not this is optional.

Discounts for Duplicate Images Only The price of the hardware unit is passed on to you at Optima's cost plus shipping and handling and is not discountable. The graphics are discounted based on duplicate volume. To determine the discount % for the multiple units, multiply the price for a quantity of one by the following factors:

Quantity	Discount Factor
2-5	.97
6-10	.96
11-15	.95
16-25	.94
26-50	.93
Above 50	Call for quote

Specifications

UL Listed Pending

Shipping Weight
Unit only 35 lbs.

Unit with Graphic 40 lbs.
Hard Case only 20 lbs.
Total ship weight 60 lbs.

Hard Case Dimension (included)
11" w x 17"d x 66"h

Unit Dimensions
(Open) 108"w x 92"h x 8"d
(Closed) 11" x 66"

Unit Color
Black

Foot Color
Black



Durable Hard Shipping Case w/Wheels (included)



SEG graphic display



Unit collapses and folds for easy assembly.

panoramic™ Lightboxes

Panoramic Lightboxes give your messages added impact!

Panoramic® lightboxes are the next generation of backlit solutions, increasing the visual impact of your booth when combined with the already known benefits of the classic Panoramic modular system. It offers homogenous lighting and easy to install graphics with silicone edging to streamline your set-up and dismantle.

Panoramic® full visual system is a solution 100% dedicated to your image.



Call For A Quote

Pricing

For Freestanding, Hanging & Wall Mounted Lightboxes call 800-844-8877 for a Quote.

Specifications

Lightbox Size

8ft Panoramic Lightbox:
94”h x 94”w

10ft Panoramic Lightbox:
94”h x 118”w

Transformer

Wattage: 30W - 60W - 150W
Input: AC 170 - 264 v 50/60 Hz
Output: 24V DC
CE / RoHS certified

Graphic Size

8ft Panoramic Lightbox:
Print Size - 94.829”h x 94.829”w
Live Size - 93.843”h x 93.843”w

10ft Panoramic Lightbox:
Print Size - 94.829”h x 118.829”w
Live Size - 93.843”h x 117.843”w

Weight

8ft Panoramic Lightbox Freestanding:
80lbs. (Hardware Only)

10ft Panoramic Lightbox Freestanding:
98lbs. (Hardware Only)

Profiles

Single-Sided Profile (X1) - 3.14” - linear density: 0.94 lbs/Lft

Double-Sided Profile (X2) - 4.72” - 1.38 lbs/Lft
Anodized gray or white

LED Lights

Strips of 3 - 5 LED lights - Cree Brand
Wattage: 2W each LED light
Voltage: 24V DC
Color Temperature: 6,500K (+ -500 K)
MTBF (estimated lifetime) 20,000 hours



Close up view of LED lights inside lightbox

Accessories

Shipping case w/ wheels

Price \$180



Dims:

Outside - 28”w x 52”h x 9.5”d
Inside - 24”w x 48” h x 9”d

2 Shipping cases will be needed for the 8ft Panoramic Ligbox and 3 Shipping cases needed for the 10ft Panoramic Ligbox.

Small Panoramic Crate

Price \$310



Dims: Inside - 21” x 13” x 98”
- Wood construction
- Intended for many shipments

6/18/2012

Display Cases

O Case

14" x 39.5"\$115*
14" x 50.75"\$120*



G Case

12" x 38"\$100*
12" x 50"\$110*
12" x 72"\$150
16" x 42"\$125*
16" x 50"\$145*



P Case

12" x 38"\$175
12" x 50"\$195
12" x 72"\$255
16" x 36"\$195
16" x 42"\$220



SYNC Case

24"w x 37"h x 15.5"d ...\$225*
Weight (approx.) ...30 lbs.



Director Chair Case

23"w x 41"h x 9"d\$165*
Weight (approx.)18.5 lbs.



Wheels for easy transportation.

Burst Case

38.5"h (including space in the top)
x 27"w x 15.5"d \$160*

Foam Pack for light storage (optional) \$20
ABS Counter top
Blotter (optional) \$10

Weight (approx.) 22 lbs.

SYNC EZ-roller Case option

38"h (including space in the top)
x 24.75"w x 13"d \$175*

Foam Pack for light storage (optional) \$20

ABS Counter top
Blotter (optional) \$10

Circumference 72"

Weight (approx.) 23 lbs.



31" Soft rolling Case\$145*

Inside: 31"h x 12"w x 12"d
Outside: 34"h x 14"w x 14.75"d
Weight (approx.)7.4 lbs.

This is considered a carrying case -
Not a shipping case.



Top View:



3x3 Burst w/graphic



4x3 US Snap w/graphic & 2 shelves



3x3 Snap w/graphic & 2 shelves

* Cases carried in stock. For the cases not carried in inventory, please allow one week delivery time to Optima. For faster turnaround on non-stock items, shipping costs will be added to the order.

Display Cases

R Case 42"
 (Retractable Bannerstand shipping case)
 Price \$95*
 Dimensions:
 (inside)5.5" x 40"h
 (external)42"h



R Case 50" (Retractable & Luminary Bannerstand shipping case)
 Price \$155*
 Dimensions:
 (inside)8" x 49"h
 (external)50"h



Grand Stand Hard Case
 Price \$185*
 Dimensions:
 48"unit7.5" x 6" x 64"h
 Weight (approx.)13 lbs.
 64" unit ...7.5" x 6" x 74"h
 Weight (approx.)15 lbs.
Price is same for both cases.



Event Tent Hard Case
 Price \$150*
 Dimensions: 12" x 72"h
 Weight (approx.)24 lbs.



Little Giant
 Price \$160*
 Dimensions:
 (inside)10.25"d x 36.5"h
 (external) ... 13" x 14" x 40"h
 Weight (approx.)25 lbs.



Black Nylon Case w/Core Tube
 Dimensions:
 5 3/4"d x 40.5"h \$25*
 5 3/4"d x 48"h \$35*



Xpressions Case
 Price \$144*
 Dimensions:
 (inside)13"w x 13"d x 35"h
 (external) ...14"w x 14"d x 41"h
 Weight (approx.)13 lbs.



InfoPlus lit stand Case
 Price \$182*
 Dimensions:
 (inside)14.5"w x 11"d x 20"h
 (external) ...17.5"w x 14.25"d x 23"h
 (Handle extended) 43.25"h



Aviator & AURA (Black w/ wheels)
 Price \$180.00*
 Dimension:
 (Outside) ... 28"w x 52"h x 9.5"d
 (Inside) 24"w x 48" h x 9"d
 Weight (approx.)25 lbs.



* Cases carried in stock. For the cases not carried in inventory, please allow one week delivery time to optima. For faster turnaround on non-stock items, shipping costs will be added to the order.

Hanging Hardware for Large Banners

Hanging Hardware is easy suspension system for large format, fabric banners.

Each system consists of 1.5" diameter silver aluminum poles that twist together and include 1/4" / 20 lb. eyebolts on each end of the assembly for effortless hanging.

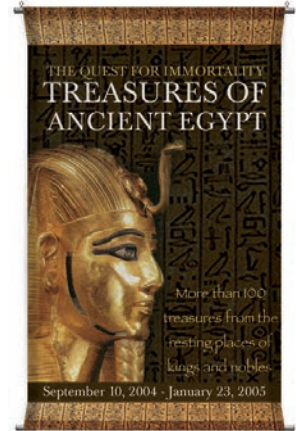

Pricing

Standard Sizes*	Per pole top or bottom cost	Total cost for set
5'	\$25 ea	\$50
10'	\$50 ea	\$100
15'	\$75 ea	\$150
20'	\$100 ea	\$200

10' Hanging Hardware w/two 5' poles top & bottom \$100
Graphic not included in price.

*Sizes that need to be different than any standard size mentioned above has a \$10 additional cut charge per top and bottom pole.

NOTE

- 20' is the maximum width available.
- Any system exceeding a 10' width will require eye bolts and supports every 10'.



Image below shows Large banner hanging in a typical environment.

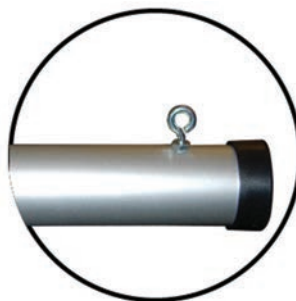

Close up of an end with eyelet.

4/19/2013

Burst & Burst SL light
 Price \$68
 Watt: 200 Halogen
 Color: Black
 Bag: Optional*



VBurst light
 Price \$42
 Watt: 150 Halogen
 Color: Black
 Bag: Optional*



SYNC light
 Price \$42
 Watt: 150 Halogen
 Color: Black
 Bag: Optional*



Price\$68
 Watt: 200 Halogen
 Color: Black
 Bag: Optional*

LED Connect Lights



(LED light strips that can be connected - Max 16 strips)

Price \$125 (Power cord not included in this price. See below.*)
 Watt: LED Color: White
 Size: 2" x 22" Weight: 2.5lbs
 Maximum of 16 LED Connect Light strips can be connected with one power cord.

* 10ft Power cord \$15 each
 1ft Jumper cord (when spacing of fixtures is required) \$6 each

Universal BCL light (Vegas Friendly)†
 Price \$55
 Bag: included in price

Watt: 35 Halogen
 Color: Silver

Use with:

- Burst & VBurst
- Xpressions
- Xpressions SNAP
- All Banner stands



50 Watt Halogen light (Vegas Friendly)†
 Price \$59
 Bag: Optional*

Watt: 50 Halogen
 Color: Black or Silver

Use with:

- Xpressions & Xpressions Snap
- Pronto
- Sprint
- Summit & Summit Style
- Range
- Relay
- The Wall*
- Aviator Table Tops*
- ClickFab*

*Requires additional \$15 clamp.



LED Pop-Up light (Vegas Friendly)†
 Price \$88
 Bag: Optional*

Watt: LED
 Color: Black

Use with:

- Burst & VBurst
- Xpressions
- Xpressions SNAP
- Sync



50 Watt Halogen light (Vegas Friendly)†
 Price \$115
 Bag: included in price

Watt: 50 Halogen
 Color: Silver

Use with:

- Media Screen XL
- Media Screen 1
- Media Screen 4
- M2
- Concierge
- Quick Screen 1 & 3
- Media Screen 2 w/adaptor - Price \$129



Wave light (Vegas Friendly)†
 Wave arm shaped spot light
 Price \$65
 Bag: Optional*

Watt: 50 Halogen
 Color: Chrome or Silver

Use with:

- Xpressions
- Xpressions Snap
- Pronto
- Sprint & Summit
- Range & Relay



***Light Bag (holds two lights)**
 Price \$30

Holds two of the following type of lights:

- Burst, Burst SL & VBurst
- LED Pop-Up
- 50 Watt Halogen
- SYNC
- Wave light



Shown w/two 50 watt halogen lights.

Media Screen 2 light adapter
 Price \$14 ea



† For more information on Las Vegas NV convention lighting requirements visit: <http://www.lvcva.com/meetings/meeting-venues/convention-centers/info/lvcc-halogen-restrictions.jsp>

Banner Rail

The Banner Rail is an aluminum hanging system with a snap-lock profile for the top and bottom of your graphic. The Banner Rail has a grip range of one thickness of paper up to .016" (0.4 mm). It profiles with hanging clips and 2 suspension hooks. The Banner Rail is Silver and comes complete with top and bottom.

Pricing:

- 24"\$15.00 per set
 - 36"\$22.00 per set
 - Suction Cups (set of 2)\$2.50 per set
 - 48"\$29.00 per set
 - 60"\$36.00 per set
- Custom sizes are available.
Please call for quote.

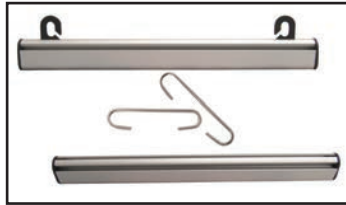

Hand-Held Fabric Steamer

Price \$58

Great For:

- Backlit fabrics
- Large wrinkled areas
- Larger displays
- Heavy fabrics



Stake (qty. 4) & Rope kit

Price\$30

To use with:

Genie and Event Tents



Magnets

- 1/2" Smooth Magnets\$.40 per foot (\$ 35.00 per 100' Roll)
- 1/2" Groove Magnets\$.40 per foot (\$ 35.00 per 100' Roll)

Boulevard Poles & Clips - (Set of 2)

Boulevard Poles are used for single or double-sided street banners and signs that are typically installed on light or electric poles.

- 24" Single\$67.00 per set of 2
- 30" Single\$69.00 per set of 2
- 24" Double\$115.00 per set of 2
- 30" Double\$120.00 per set of 2
- 36" & 48" sizes available

Please call for quote



BANNER ACCESSORIES

Various decorative or functional items used in hanging banners.



Chain two styles and weights that can be sewn into the banner hem to add weight.

- Heavy (1lb per 3ft) Price...\$2.75/Lft
- Light (0.5lb per 3ft) Price...\$2/Lft

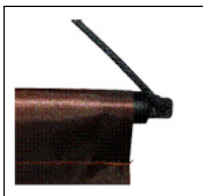

Wood dowels and caps 0.5" Poplar rods can be used for weight or to hang smaller banners.

- 36"dowel \$2.00
- 48" dowel \$2.50
- Per cap \$0.50
- Cut charge ... \$5.00

Black rope 0.125" black decorative rope can be used to hang small banners.

Price\$0.50 per Lft of rope

Spline Roller

Price\$10

Designed to make it easier to apply fabric graphics with the beaded finishing into extrusion based structures. The tool has two sides one wheel is round edge and the other a grooved or concave edge.

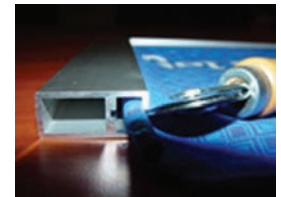

View of Spline Roller being used.

Ground Stake

Price\$51 each

Weight: 2.3 lbs.



Aluminum bar

add weight to you banner by sewing into the bottom hem.

Price \$2.50/Lft



Sand Bag (holds 50lbs.)

Price\$2 each

Open: 26"x14" Color: White

To use with: BaseLine, Cocierge, Forum (Outside), Skyblade, Rally Banner, Banshee & Any outdoor event displays.

Exhibit Pipe & Drape hook

(each holds up to 10lbs.)

Price \$0.50 each - sold in sets of 10

Size: 3"w x 3.75"h

Thickness: .105"

Color: Silver

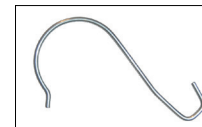

Small S-shaped hook typically used for hanging a new banner over existing pipe and drape.

Ball Bungee (Black) \$2.00 each

- White available on request



Velcro (Adhesive Back)

- New Style (white hook)
 - 1/4"\$.15 per foot
 - 600' Roll\$60
- Velcro Dots
 - 1/2"\$.72 per foot
 - 75' Roll\$48
- Old Style
 - 5/8" white hook
(splits in half to two 5/16" strips)\$.30 per foot
 - 75' Roll\$20
 - 5/8" white loop, black loop,
black hook\$.32 per foot
 - 75' Roll\$22

Double Wing Easle Backs

Price \$5 each
 Sizes available: 8", 10", 12", 15", 18", 22"

Yard Stakes (Metal)

Price\$9.50 each
 To use with: Coroplast graphics in outdoor environments.

Fixture Adapter

Price\$82
 (Customer is responsible for cutting the graphic for the Fixture Adapter accessory.)



Weight Limit = 15 lb. maximum

The Fixture Adapter accepts a variety of hooks, shelves, baskets, etc. The following fixtures are in stock, but you can use fixtures from your local store, or you can contact one of the following:

www.fixtures-displays.com
 1-800-821-5748

www.omahafixture.com
 1-800-531-662

www.storefix.com
 1-877-570-2001

Fixtures in Stock:

- 12" L x 8" W x 4" D Black Wire Basket ...\$8 
- 12" L x 8" W x 4" D White Wire Basket ...\$8
- 10" L x 4" W Clear Plastic Shelf\$3 
- 12" L x 6" W Clear Plastic Shelf\$4
- Single Hat/Cap Display\$3 
- 5 J-Hook Waterfall\$5 
- 6 Ball Waterfall\$5 
- 8" Peg Hook / Chrome Finish\$2 
- 4" Peg Hook / Chrome Finish\$2 

Monitor Mount:

Use for monitors sized 13" to 26"
 Price \$68 each



Large Flat Panel Monitor Mount:

Use for monitors sized 30" to 60"
 and holds up to 130lbs.
 Price \$124 each



Additional structure and support required when using monitor mounts. Contact your Account Representative for details.

FineEdge: (Not available for profile cut substrate.)

A Plastic Profile that can be applied to substrate edges to get a clean finished look. Great for dressing up direct to substrate prints for contests at shows, retail use and more. Each profile is designed for 1/4" or 1/2" surface coverage.

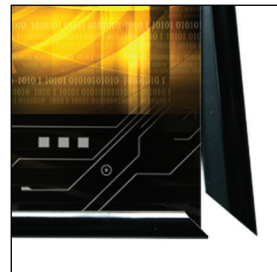

Sizes / Pricing / Colors:

- 1/8"\$1.50 / LnFt *
- 3/16"\$1.50 / LnFt †
- 1/4"\$1.50 / LnFt †
- 1/2"\$2.50 / LnFt †

* Polished Black available only
 † Polished & Matte Black available

Apply To: Sintra, UltraBoard, Coroplast and Foamcore

Important: Two hangers are supplied for substrates NOT exceeding Max sizes below:

- 1/8" sintra - 16sqft • 1/4" sintra - 8sqft
- 1/2 Ultraboard - 20sqft • 3/16" Ultraboard - 32sqft
- 4mm Coroplast - 32sqft

- Substrates larger will need hangers and supports supplied by the customer.
- Wire not included. Source your local framing or hardware store.
- FineEdge is not available without a graphic purchase.

Z-Cleat: Metal clip system to hang a rigid substrate on a wall.

Price \$2.50 / ft per bar (2 bars needed per graphic. One for back of graphic and one for wall.) For use indoors.
 Size: Custom up to 72" long Color: Silver

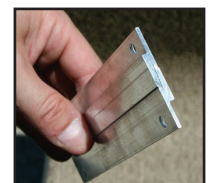
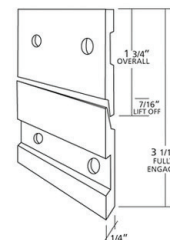

Accounting

1. Each customer must have a completed credit application on file with Optima. This application must be completed and returned prior to shipments being released. The credit application must be signed by an officer of the company. This is required for all customers, whether on prepay or terms.
2. Orders require pre-payment unless a company has a completed and approved credit application on file prior to order shipment. Acceptable forms of payment: Company check, credit cards - **Visa, Master Card, Amex, Discover cards**, and ACH payment. Once a customer's credit application is complete standard terms will be extended and orders will be subject to approved credit limits.
3. The account must be kept current in order to remain on terms. It will be at the discretion of Optima Graphics Inc. to change the status and make all shipments revert to a "prepay only" status if the account becomes habitually late and/or difficult to collect.
4. Invoice Balances that are 45 days old will be charged a 1.5% per month interest charge.
5. A 2.5% prepay discount is offered for payment with order. We accept **Visa, Master Card, Amex and Discover card**, company checks and ACH payment. However, if there is an outstanding past due balance on the account, no prepay discount is available. This discount is offered solely at the discretion of Optima Graphics, Inc. and may be denied to any customer without explanation.
6. Frequently we offer special discounts for various reasons. There may be an occasion that these discounts are so substantial that the prepay discount would be eliminated on that particular order.
7. If an account needs to be sent to collections due to its' delinquency, the customer will be required to pay all fees including, but not limited to, legal fees and accrued interest.
8. Any returned checks will require the customer to send certified funds to pay for the returned item(s), as well as an additional \$25.00 per item processing fee. Pending orders will be placed on hold until the funds are received to pay for the returned item.
9. Any single order over \$20,000 requires a 50% deposit.
10. Optima Graphics assent to this sale is expressly conditional to the terms found at: <http://www.standardtermsofsale.com> and no terms of the buyer which are different or additional to or in conflict with those herein are accepted.

Turnaround

1. Standard Turnaround is four business days unless otherwise requested. Orders with four days or less will be shipped via priority overnight or standard overnight service and billed as such. There are no rush charges.
2. Rapid Response Next Day Shipments – Lambda Bright Murals up to 4 mural panels with endcaps, any one of our Banner stands with graphic, quantity 1 or 2 Permalogo or Applique table throws will be available for shipping the day after the PO and art is received using any shipping method requested. Art and PO must be received by Optima no later than 5:30pm CST.
 - a. Lambda Bright Murals with or without endcaps qualify for next day shipments
 - b. Permalogo projects that require more than 3 colors, please speak to your Account Representative
 - c. Custom sized table throws do not qualify
 - d. An order is considered ready to produce with receipt of complete PO and print ready art
 - e. Any order received after 5:30pm CST will be counted as if it were received on the next business day. For example, if an order is received after 5:30pm CST on a Monday, the order will be defined as receipt on Tuesday and will ship Wednesday for the earliest available ship date.
 - f. For jobs that fall into the Rapid Response Program and a proof is requested, the Rapid Response

time line does not begin until Optima has final approval of the proof to produce. Final approval to Optima will follow the 5:30pm CST guideline as listed above.

3. Rapid Response Same Day Shipments – All hardware only jobs ship the same day the PO is received using any shipping method requested. The PO must be received by Optima no later than 4:00pm CST.
4. Same Day Service – Same day service jobs will be accepted until noon CST with a guarantee to make our last Fed Ex pick up.
 - a. Same Day Service jobs received after noon CST will ship Air Freight if not completed by our last Fed Ex pick up and will be billed as such. Please notify your Account Representative immediately if Air Freight is not an option for your order.
 - b. Same Day Service orders may not be a feasible shipping offer based on size, complexity of order and any non stocked inventory request.
 - c. Optima will always do its best to produce the highest quality graphics, and the vast majority of Same Day Service orders will meet our high quality standards, however, when Same Day Service is requested, we may not have sufficient time to reproduce your order if an error or defect is found during inspection.
5. All shipping is FOB St. Louis, MO.
6. Fulfillment charges will apply to all orders with 10 or more shipping addresses. Orders requiring fulfillment must be quoted.

Art File

1. Complex custom cut files require a cut path. If no cut file is provided Optima will offer a quote to create one. Tech Support will identify any images that require this service.

Graphic prices are based on receiving art files that are print ready. For art that is not print ready, the following charges may be applicable:

- Call for a quote for any image manipulation and graphic design time.
- Scans are \$60 each.
- For any graphic design or image manipulation generated for graphics not produced at Optima call for a quote.

2. Renderings are available as follows:

- Basic rendering in jpeg or PDF format add \$45.00
- Advanced renderings (ex. 3D rendering) add \$90.00 plus an additional \$85.00 per hour for advanced renderings of multiple units and environments.

3. Message in motion design is available at \$150.00 per hour and can include: multimedia design, animated gifs, flash/quick time presentations and other non graphic production needs.

4. All files are archived at no charge. The charge for retrieving an archived art file, copying to a disk, emailing or uploading to an FTP site is \$75.00 (plus shipping if applicable). If the art is returned to Optima for production of a project, the retrieval fee will be waived. Art will NOT be pulled without written consent from the company who placed the original order through Optima.

5. There is a \$25.00 color match fee per image for non Pantone/PMS color matches. This includes photos, provided graphics, substrates, laminated chips, brochures or other printed pieces, actual products samples, etc.

6. Flattened files which require color matches may incur charges at \$85.00 per hour to outline the color match areas. It is best to send layered files to avoid these charges.

Proofs

1. All proofs are available on a request basis. Proofs are only provided when requested.
2. All printed proofs include a printed scale version of the original image and a 1:1 test strip at full size printed using the process and material that the final product will be produced on.
3. All physical proofs will be shipped via priority overnight service from Optima no later than 48 hours from receipt of P.O. and production ready art. Typical timing is 24-48 hours from receipt of P.O. and production ready art.
4. All printed proofs include up to 3 revisions at no additional proof cost unless new artwork is provided. For proofs using new artwork, please apply the appropriate charges listed below.
5. Shipping charges will apply to all printed proofs.
6. Email proofs are no charge and will be sent within 24-48 hours. An email proof is provided in jpeg format unless otherwise specified.
7. Faxed proofs are no charge.
8. All Lambda proofs are \$25.00. Proofs for a mural that includes 3 or more panels are free.
9. All Dye sublimation proofs are \$25.00. Proofs for a VBurst, Burst or Burst SL that are 3x3 or larger are free.
10. All UV direct print proofs are \$25.00
11. All Solv-it proofs are \$25.00
12. Proofs for Xpressions skins only are \$25.00 each.
13. Full Configuration/Mapping proofs for the Xpressions product lines are \$45.00 each and include a scale version of each skin and 2 individual 1:1 areas at full size.

Quantity Discounts

Discount applies to graphics only.

Duplicate images only. Multiply the price of the single graphic by the Discount Factor for the specific amount of multiples, and then multiply that number by the number of graphics. Use the discount chart below:

Duplicate Quantity	Discount Factor: Lambda	Discount Factor: Kaleidoscope, Colossus 4 or 8 color, Select and Traditional
2	.9250	.9550
3	.9000	.9300
4	.8875	.9175
5	.8700	.9000
6-8	.8500	.8800
9-14	.8250	.8550
15-20	.7900	.8200
21-26	.7800	.8100
27-35	.7700	.8000
Above 35	Call for a quote	Call for a quote

Miscellaneous

1. All graphics have a minimum size restriction of 1 square foot of material and will be billed as such.
2. Warning for all outdoor products: Do not display your outdoor products in extreme winds and / or thunderstorms. Do not use near overhead wires. Displaying in high winds or near overhead wires may result in property damage, injury or death and will void any and all existing warranties.
3. Showroom Discounts are available through your Account Executive. Call for details. All offers, promotions and discounts are subject to end at anytime with out warning. Optima reserves the right to modify and change any offers at any time without warning. Showroom Discounts do not include Display Cases, Lights and Technology.

● Ordering From Optima

Call 800-844-8877 and ask for Customer Service.

- 2. Fax your Purchase Order to 636-349-0749 and send your artwork via FTP to www.aproofnow.com, email to artwork@optimagfx.com or ship directly to optima Graphics.
- 3. Call Keith Simpson at extension 255 for any questions about file preparation.
- 4. Contact Gary Camarato at extension 247 for any creative graphic design work.
- 5. Your graphics order will be placed into production and you will receive an order verification.

● Contacting Optima Graphics

Address:
Optima Graphics, Inc.
1540 Fencorp Drive
Fenton, MO 63026

Email: artwork@optimagfx.com

www.aproofnow.com & [ftp.aproofnow.com](ftp://ftp.aproofnow.com)
(no password required) username: ftpuser
password: ftp0401

Toll Free: 1-800-844-8877

Direct: 636-349-3396

Fax: 636.349.0749

Price book: www.optimagfx.com

Generic Catalog: www.visproducts.com

Art & File Preparation Guidelines are available at www.optimagfx.com

Graphic Design Benefits & Capabilities

The Optima Design Group is a true value to you and your customers. Having a staff of truly creative graphic designers under the same roof as the production facility translates into swift and efficient realization of your customer's vision.

Our design staff has over 70 combined years of graphic design experience in the tradeshow industry. We know how to get the most out of the visual environments that exhibit houses create. This value added service helps you lock-in customers.

Optima Design Benefits

- **Speed and Efficiency:** much faster than typical design groups. Contacts are returned within an hour and we schedule your design to be completed as soon as possible.
- **Wholesale Approach:** We work under your direction, with you, you and your client or directly with your client. Our designers keep you informed every step of the way. We never discuss money or terms with your client. Instead we focus on the creative side and defer this part of your business to you.
- **Art to Specifications:** we create our files for our output devices.
- **Color Control:** we work in concert with pre press production and in house color management team to produce best possible color results.
- **Xpressions Experts:** no one has designed more Xpressions displays! We have the greatest understanding of Xpressions from both a technical and a creative standpoint.
- **E-Proofing:** is complete with all important information and are free of charge.
- **Hard Proofs:** are on the actual product. Output of hard proofs are from the exact device the final will be generated on. Color and quality exact to the final!
- **By Pass Preflight:** upon approval the artwork goes straight to production. No pre flight is required since art is set up to production specifications. Speeds up turnaround, is more efficient and keeps projects within deadline.
- **No Last Minute Added Charges:** Often art created by other designers is not set up for large format or our production requirements, adding cost and time to your order.
- **Full Staff of Design Professionals:** our designers are knowledgeable, creative, extremely responsive and responsible. With a combined over 70 years experience, you will receive creativity combined with a customer centric attitude that will exceed your expectations.
- **Quality and Creativity:** all the attention to detail and quality you would expect from a premium priced agency. The big difference is you don't have to wait as long to get your design and our fees are lower.



- **Creative Graphic Design:** everything from last minute adjustments to your existing art to full blown creativity from scratch.
- **3D Rendering:** basic white background with display or advanced full environment. No one has designed and rendered more expressions than Optima!
- **High Resolution Scanning:** high quality flatbed photos, including reflective photos and transparencies; other provided items. Color correction and Photoshop retouching per your direction.
- **Branding and Identity Development:** logo design and corporate branding including tag lines, color identities and more. We provide you with everything you need to maintain consistency while conveying your corporate image and message.
- **Print Design:** brochures, business collateral, folders and any offset or process print item you may require. We provide professionally prepared artwork for your offset or process printer.

SERVICE	COST
Design/Not Printed	Call for a quote
Graphic Design	Call for a quote
Basic Render*	\$45 each
Advanced Render*	\$90 each
Proposal Layout*	\$150 each

* Renders may require added design time



Basic Render \$45

A Basic Render is merely meant to show your client what their artwork will look like on a structure. The floor and background is white, with no specific lighting or shadows.



Advanced Render \$90

An Advanced Render is not only meant to show your client what their artwork will look like on a structure, but what it will look like in an environment with appropriate lighting, shadows and atmosphere.

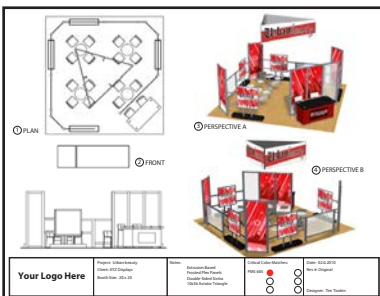

Proposal Layout \$150

A Rendered Proposal is tailored to the client's needs. 4 views are included, top elevation, front elevation, isometric and perspective, the perspective view included is the equivalent to an advanced render. Technical data about the render and space, time stamps, version numbers and other pertinent data are included as well. There is also a space for the client's logo and contact information to appear. Structural drawings for Optima products are used or you can supply your custom structural drawing.

Lifetime Hardware Warranty

Optima Graphics, Inc. is pleased to offer a lifetime warranty on all hardware products purchased from Optima Graphics. Policy applies to original purchaser. No product registration is required. Optima Graphics will replace or repair all hardware supplied to our customers purchased after 7.7.09. However, Optima Graphics does reserve the right to inspect hardware and exclude warranty claims that have resulted from vandalism, theft, negligence, fire, natural disasters, modifications, or losses in shipment that may be covered by your insurance and/or freight carrier. Lifetime hardware warranty does not apply to graphics produced by Optima Graphics nor electrical components. Please contact your Account Representative with any questions relative to graphics or graphic production. Warranty repairs will follow general turn around times and will need to be coordinated and processed through Optima Graphics customer and not directly through the end client. All shipping costs are the responsibility of the customer.

Optima Graphics will also make available, for all reasonable requests, appropriate replacement parts so Optima Graphic's direct customers have the option to make necessary repairs themselves. Items such as scissors and hubs can be requested from and shipped from Optima Graphics at no cost including free ground shipment. If receipt of replacement parts requires expedited shipping, Optima will bill its direct customer for those expedited shipping costs.

Please contact your Customer Service Account Representative or Account Executive for questions concerning this policy.

NOTE: Electronic products are not covered by optima's Lifetime Hardware Warranty.



HDL Guarantee

HDL is a premier laminate in the market. It has a satin or matte surface finish, is scratch and ding-resistant, immune to edge delamination, prevents tunneling and is rollable in either direction. Due to its high quality and durability, the HDL has a Lifetime Guarantee against delamination. Any HDL graphics which delaminate during normal usage, will be replaced at no cost as long as the customer owns graphic. However, if they have been improperly handled such as rolled to tight, folded etc. the graphic will not be covered by the guarantee.

HDL Satin: A durable thermal laminate sandwich with a satin finish and gloss backing.

HDL Matte: A durable thermal laminate sandwich with a matte finish and gloss backing.



2N1.....CM-1

A

Alfresco BS-1 & O-1
 Aviator Hanging Structures..... HA-1
 AURA HS-1 & X-2
 AURA Lambda Duratrans X-6

B

Ball Bungee L-3
 Banner Rail L-3
 Banshee O-2
 Barricades Covers O-17
 Baseline O-4
 Big Banner Finishing GD-1
 Boulevard Poles O-16

C

Chairs T-1
 ClicFab HP-1
 Colossus..... GD-2
 Compass BS-2
 Concierge BS-3
 Controltac Positional Vinyl..... GU-2
 Coroplast GU-2
 Courier..... BS-4
 Counters..... CM-1
 Custom Cuts GU-3

D

Decals GU-3
 Dry Erase GL-5
 Duo Hello CM-11

E

Easels L-4
 Eco-1st Bamboo Retractable BR-1
 Eco-1st Bamboo L-stand BS-5
 Event Tent O-5
 Expand Podium CM-10
 Expolinc Roll Up Classic BR-18
 Expolinc 4Screen Classic BS-7
 Expolinc Soft Image Counter...CM-4
 Exhibit Pipe & Drape Hook L-3

F

Fixture Adapter L-4
 FineEdge L-4
 Flexible Lexan Graphics GV-1
 Flocking T-7

G

Grand Stand BR-2
 Graphic Cases C-1
 Graphic Design J-4

H

Hanging Hardware for
 large banners L-2

I

Infinity HS-2
 InStep Carpet Graphics GD-8
 iPad Kiosk..... iP-1
 iPad Clamshell..... iP-3
 iPad Clamshell swivel..... iP-4

K

Kaleidoscope Select GD-3
 Kapow O -15

L

Lambda GL-2
 LED light frame X-3
 Lettering & Logos GV-2
 Lights L-2
 Little Giant TC-2

M

M2 BR-3
 Magnets L-3
 Maxibit Scene Ultralight BB-6
 MediaScreen 1 BR-4
 MediaScreen 2 (indoor) BR-5
 MediaScreen 2 AWD BR-7 & O-8
 MediaScreen 4 BR-6
 MediaScreen 3 BR-20
 MediaScreen XL..... BR-8
 Mesa..... GU-1
 Modesto..... TC-5
 Multiplier BS-6

N

Nouveau HS-3
 Nouveau Trade Show Kits..... HS-5

O

Outpost O-9

P

Panoramic HS-6
 Panoramic Kits HS-30
 Panoramic Lightboxes HS-40
 Panoramic iPad Kiosk HS-39
 Pipe Structures..... HP-1
 Pliiko HS-35
 UV direct print GU-2
 Pronto BR-9
 Pronto 2..... BR-11
 Power Panel X-4
 Proofs J-3

Q

QuickDrop HP-3
 QuickScreen 1 BR-14
 QuickScreen 3 BR-16
 QuickFab 8ft HP-1
 QuickFab 10ft HP-2

R

Rally Banner O-10
 Range BB-1
 Reposition-it GU-4
 Relay BB-2
 Ridgeline O-11

S

Salesmate PK-34
 Salesmate LED Lightbox PK-34
 Sandbags L-3
 SEG HS-26 & GD-6
 the Set BR-19
 Select PK-10
 Sidewinder BR-17
 Skyblade O-12

Solv-it! GS-1
 Spennare Monitor Mount CM-8
 Spline Roller L-3
 Sprint BT-1
 Steamer (hand held) L-3
 Streetag GU-5
 Structures HT-1
 Summit BT-3
 Summit style BT-5
 SYNC PS-1

T

Table Throws T-3
 Table Tops TT-1
 Tension Fabric Graphics HT-1
 Twist PT-1

U

uVision-it GU-6
 Ultimate Backlit header sys ... X-5
 Ultra Light X Series TT-10

V

Valet O-14
 vBurst PF-1
 vBurst Backlit..... PF-6
 Velcro L-4
 Vinyl graphics on substrates .. GV-3
 V-Throw T-8

W

Wall BB-3
 Window Perf GS-3

X

Xpressions CONNEX PK-24
 Xpressions Express..... PK-22
 Xpressions LED Lightbox PK-20
 Xpressions Monster Monitor .. TC-10
 Xpressions PUSHTHRU..... PK-40
 XpressionsSnap PF-1
 Xpressions Sheer PK-31
 Xpressions 223 Counter..... CM-3
 Xpressions 223 Workstation ...CM-6

Y

Yard Stakes L-3